

MAXIM

MAX3863 Evaluation Kit

Evaluates: MAX3863

General Description

The MAX3863 evaluation kit (EV kit) is an assembled demonstration board.

The MAX3863 EV kit contains two circuits, one for electrical evaluation and one for optical evaluation. The output of the electrical evaluation section is interfaced to an SMA connector, which can be connected to a 50Ω terminated oscilloscope. The output of the optical evaluation section is configured for attachment to a laser/monitor diode.

Component Suppliers

SUPPLIER	PHONE	FAX
AVX	843-444-2863	843-626-3123
EFJohnson	402-474-4800	402-474-4858
Murata	415-964-6321	415-964-8165
Venkel	800-950-8365	512-794-0087

Note: Please indicate that you are using the MAX3863 when contacting these component suppliers.

Features

- ◆ Fully Assembled and Tested
- ◆ 3.3V Operation
- ◆ Fully Matched for Best Return Loss
- ◆ Independent Electrical Monitoring of Modulation and Bias Currents
- ◆ Automatic Power Control (APC) Loop Test Circuit

Ordering Information

PART	TEMP RANGE	IC PACKAGE
MAX3863EVKIT	-40°C to +85°C	32 QFN

Electrical Component List

DESIGNATION	QTY	DESCRIPTION
C15, C16, C25, C26, C29, C31, C32, C37, C45	9	0.01μF ±10%, 10V ceramic capacitors (0402)
C18, C21, C23, C24, C27, C28	6	0.1μF ±10%, 10V ceramic capacitors (0402)
C30	1	470pF ±10%, 10V ceramic capacitors (0402)
C35	1	0.015μF ±10V, 10% ceramic capacitor (0402)
C40	1	10μF ±10%, 10V tantalum capacitor, case B
C41	1	0.01μF ±10%, 10V ceramic capacitor (0603)
D3	1	LED red T1 pkg Digi-Key P363-ND
J5–J8	4	SMA connectors, edge mount, round contacts EFJohnson 142-0701-801 Note: Cut center pin to approximately 1/16in length.

DESIGNATION	QTY	DESCRIPTION
J9	1	SMA connector, edge mount, tab contact EFJohnson 142-0701-851
JU4	1	4-pin header, 0.1in center Digi-Key S1012-36-ND
JU4, JU7, JU9, JU10, JU12, JU16, JU19	7	Shunts Digi-Key S9000-ND
JU7, JU12, JU16, JU19	4	2-pin headers, 0.1in centers Digi-Key S1012-36-ND
JU8, JU11, JU13, JU14, JU17, JU18	6	Open
JU9, JU10	2	3-pin headers, 0.1in centers Digi-Key S1012-36-ND
L7, L12	2	33μH inductors (0805) Toko FSLB2520-330K
L9	1	1.2μH inductor Coilcraft 1008CS-122XKBC

MAX3863 Evaluation Kit

Evaluates: MAX3863

Electrical Component List (continued)

DESIGNATION	QTY	DESCRIPTION
L10, L11	2	2 μ H inductors (0603) Murata BLM18AG601SN1
Q2	1	PNP XSTR Zetex FMMT591
R4, R5, R26, R28, R37, R42	6	Open
R12, R13, R43	3	100k Ω variable resistors Bourns 3296
R17	1	200 Ω \pm 1% resistor (0603)
R22	1	49.9 Ω \pm 1% resistor (0402)
R23, R25	2	Open (0402)
R29	1	3.92k Ω \pm 1% resistor (0402)
R30, R31	2	100 Ω \pm 1% resistors (0603)
R32	1	499 Ω \pm 1% resistor (0402)
R33, R40	2	0 Ω resistors (0402)
R34	1	1.5k Ω \pm 1% resistor (0402)
R38	1	10k Ω \pm 1% resistor (0402)
R41	1	Open, variable resistor
R46	1	15 Ω \pm 1% resistor (0603)
R47	1	604 Ω \pm 1% resistor (0603)
R51	1	24.9 Ω \pm 1% resistor (0402)
TP2, TP3, TP8, TP10–TP13, TP17, TP18, TP20–TP28, TP31, TP32	20	Test points Digi-Key 5000K-ND
U2	1	MAX3863EGJ 32-pin QFN Note: U1 has an exposed pad, which requires that it be solder attached to the circuit board to ensure proper functionality of the part.
U3	1	MAX495ESA 8-pin SO

Optical Component List

DESIGNATION	QTY	DESCRIPTION
C1–C5, C9, C14, C17, C33, C38	10	0.01 μ F \pm 10%, 10V ceramic capacitors (0402)
C6	1	0.015 μ F \pm 10%, 10V ceramic capacitor (0402)
C7, C10–C13	5	0.1 μ F \pm 10%, 10V ceramic capacitors (0402)
C8	1	470pF \pm 10%, 10V ceramic capacitor (0402)
C19	1	10 μ F \pm 10%, 10V tantalum capacitor, case B
C20, C22	2	0.01 μ F \pm 10%, 10V ceramic capacitors (0603)
C34	1	1pF \pm 10%, 10V ceramic capacitor (0201)
C36	1	100pF \pm 5%, 10V ceramic capacitor (0603)
D1	1	LED, red T1 pkg Digi-Key 363-ND
D2	1	Laser diode, not included
J1–J4	4	SMA connectors, edge mount, round contact EFJohnson 142-0701-801 Note: Cut center pin to approximately 1/16in long.
JU1, JU2	2	3-pin headers, 0.1in centers Digi-Key S1012-36-ND
JU1, JU2, JU3, JU15	4	Shunts Digi-Key S9000-ND
JU3	1	4-pin header, 0.1in center Digi-Key S1012-36-ND
JU15	1	2-pin header, 0.1in center Digi-Key S1012-36-ND
L1	1	33 μ H inductor (0805) Toko FSLB2520-330K
L2, L5, L6	3	2 μ H inductors (0603) Murata BLM18HG601SN1
L4	1	1.2 μ H inductor (1008) Coilcraft 1008CS-122XKBC

MAX3863 Evaluation Kit

Evaluates: MAX3863

Optical Component List (continued)

DESIGNATION	QTY	DESCRIPTION
R1	1	499Ω ±1% resistor (0402)
R2, R3	2	2kΩ ±1% resistors (0603)
R6, R14, R16	3	100kΩ variable resistors Bourns 3296W
R7, R15	2	0Ω resistors (0402)
R8	1	Open, variable resistor
R9	1	82Ω ±5% resistor (0201)
R18	1	200Ω ±1% resistor (0603)
R19	1	2kΩ ±1% resistor (0402)
R20	1	20Ω ±1% resistor (0402)
R21	1	10kΩ ±1% resistor (0402)
R24	1	3.92kΩ ±1% resistor (0402)
R27	1	24.9Ω ±1% resistor (0402)
R36	1	Open (0402)
R39, R45	2	100Ω ±1% resistors (0603)
R48	1	1.5kΩ ±1% resistor (0402)
TP1, TP4-TP7, TP9, TP14, TP15, TP16, TP19, TP29, TP30	12	Test points Digi-Key 5000K-ND
U1	1	MAX3863EGJ 32QFN Note: U1 has an exposed pad, which requires that it be solder attached to the circuit board to ensure proper functionality of the part.
None	1	MAX3863 evaluation circuit board, rev B
None	1	MAX3863 EV kit data sheet
None	1	MAX3863EGJ data sheet

Quick Start

The MAX3863 EV kit contains two circuits, one for electrical evaluation and one for optical evaluation. The optical circuit has solder pads suitable for mounting a laser diode module with a built-in monitor diode. The electrical circuit has a connector for a 50Ω oscilloscope hookup. In the electrical circuit, the monitor diode feedback is simulated by a current-controlled current source formed by U3 and Q2.

Electrical Evaluation

- 1) If the data is latched, place the shunt for JU10 to ground RTEN to enable the clock input. Otherwise, set JU10 so that RTEN is connected to VCC.
- 2) Set the shunt JU9 to ground the EN input so that the MAX3863 is enabled.
- 3) Remove JU16 to enable the APC loop. The bias current is controlled by R43 and the gain of the APC test circuit. See Figure 2.
- 4) Remove JU4 to disable modulation compensation.
Note: When performing the following resistance checks, manually set the ohmmeter to a high range to avoid forward biasing the on-chip ESD protection diodes.
- 5) Adjust R13, the MODSET potentiometer, for 5.9kΩ between TP3 and ground. This sets the modulation current to approximately 40mA. Refer to the MAX3863 data sheet to program other values of I_{MOD}.
- 6) Adjust R12, the BIASMAX potentiometer, for 2kΩ between TP2 and ground. This allows the APC loop to control I_{BIAS} up to 100mA.
- 7) Adjust R43, the APCSET potentiometer, for 4.7kΩ between TP10 and ground. This sets I_{MD} to 1.25mA. Given the APC test circuit gain of 0.025mA/mA, the required bias current is approximately 50mA.
- 8) Apply a differential input signal of 250mV_{p-p} to the DATA inputs, and to the CLK inputs if retiming is enabled.

INPUT VOLTAGE RANGE	
Peak-to-peak differential voltage	200mV to 1600mV
Instantaneous voltage	V _{CC} - 1.5V to V _{CC} + 0.5V

- 9) Attach a high-speed oscilloscope with 50Ω inputs to J9.
- 10) The bias current can be measured by:

$$I_{BIAS} = \frac{V_{TP13} - V_{TP22}}{15\Omega}$$

- 11) Power up the board with a +3.3V supply.
- 12) Add modulation compensation by installing JU4. Connect R34 to the MODCOMP pin to increase the modulation current by 0.5 times the bias current.

MAX3863 Evaluation Kit

Optical Evaluation

- 1) If the data is latched, place the shunt for JU2 to ground \overline{RTEN} to enable the clock input. Otherwise, set JU2 so that \overline{RTEN} is connected to VCC.
- 2) To enable the part, set shunt JU1 so that \overline{EN} is grounded.
- 3) To disable the APC loop, install JU15. This allows direct control of the bias current.
- 4) To eliminate interaction between the bias current and the modulation current, remove JU3.
- 5) The EV kit is designed to allow connection of various laser/monitor diode pin configurations. Connect a TO-header style laser with monitor diode (Figure 1) as follows:
 - Keeping the module leads as short as possible, connect the laser diode cathode to the center pad on the component side of the circuit board. Connect the anode to one of the two remaining VCC pads, such that the monitor diodes leads can solder to the bottom of the circuit board.
 - The monitor photodiode pads are arranged in a series of five pads on the bottom (solder side) of the PC board. Next to the five photodiode pads are three solder bridge pad pairs. The MD pin can be connected to any three of the five pads through a solder bridge. The remaining two of the five pads are connected to VCC. The VCC pads are placed between the pads going to the solder bridge pads. Solder the photodiode to the nearest two of the three pads going to the solder bridge pads (Figure 1).
 - Connect the anode of the photo diode to the MD pin by adding a solder bridge to one of the three solder bridge positions. Connect the photodiode cathode to VCC by bridging the cathode pad to the adjacent VCC pad.

Note: When performing the following resistance checks, manually set the ohmmeter to a high range to avoid forward biasing the on-chip ESD protection diodes.

- 6) Adjust R16, the MODSET potentiometer, for maximum resistance between test point 3 and ground.
- 7) Adjust R14, the BIASMAX potentiometer, to give a bias current larger than the threshold current specified for the laser diode. A combined resistance value of 5.9k Ω gives approximately 40mA of bias current:

$$I_{\text{BIAS}} = 200 \times \frac{1.2\text{V}}{R_{\text{BIAS}}}$$

- 8) Apply a differential input signal of 250mV_{P-P} to the DATA inputs, and to the CLK inputs if retiming is enabled.

INPUT VOLTAGE RANGE	
Peak-to-peak differential voltage	200mV to 1600mV
Instantaneous voltage	V _{CC} - 1.5V to V _{CC} + 0.5V

- 9) Attach the laser diode fiber connector to an optical/electrical converter.
- 10) Power up the board with a +3.3V supply.
- 11) Adjust R16 until the desired optical amplitude is achieved. Optical amplitude can be observed on an oscilloscope connected to an optical/electrical converter. If the signal clips, the bias current might need to be increased. Refer to the *Design Procedure* section of the MAX3863 data sheet to set the modulation compensation factor.

MAX3863 Evaluation Kit

Adjustment and Control Descriptions (see Quick Start first)

COMPONENT		NAME	FUNCTION
ELECTRICAL	OPTICAL		
D3	D1	FAIL INDICATOR	The LED goes out if the monitor diode current is equal to its set point. If I_{BIAS} reaches $I_{BIASMAX}$ before I_{MD} reaches its set point, the LED lights.
JU4	JU3	MODULATION COMPENSATION	Controls the amount of I_{MOD} that is proportional to I_{BIAS} . Remove to make I_{MOD} independent. Refer to the MAX3863 data sheet.
JU9	JU1	OUTPUT ENABLE	Enables/disables the current outputs. Shunt to ground for normal operation. Remove to switch modulation and bias outputs off.
JU10	JU2	RETIMING ENABLE	Enables/disables data retiming. Shunt to ground to enable data retiming. Remove shunt for direct data transmission.
JU16	JU15	APC LOOP ENABLE	Install to set $I_{BIASMAX}$. Remove to enable APC loop.
R12	R14	BIAS ADJUST	Adjusts laser bias current.
R13	R16	MOD ADJUST	Adjusts laser modulation current.
R43	R6	APC SET POINT ADJUST	Adjusts monitor diode set-point current. When the APC loop is enabled, the bias current increases until the monitor diode current is equal to its set point.

Evaluates: MAX3863

MAX3863 Evaluation Kit

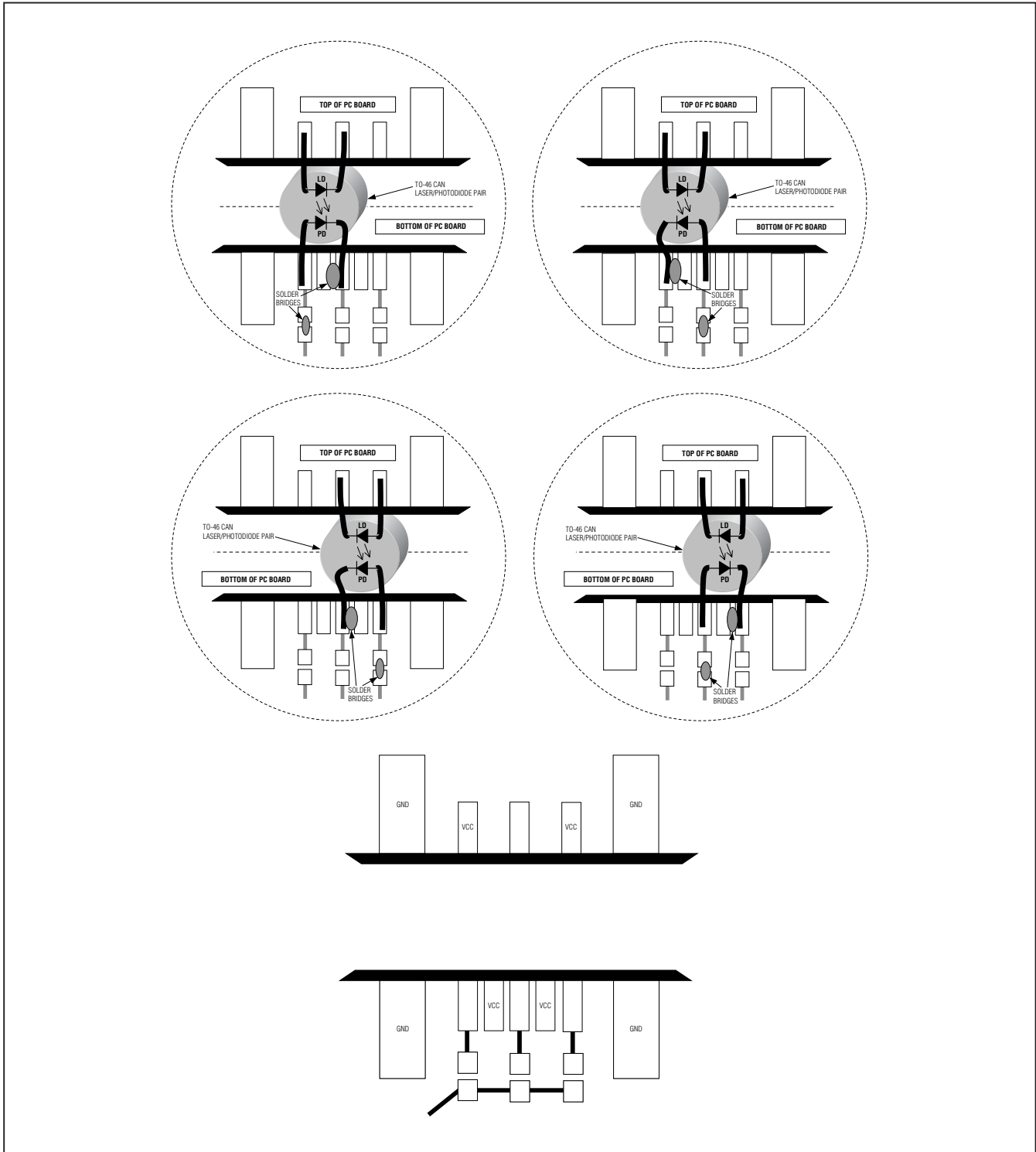

Figure 1. Laser Diode/Monitor Diode Attachment to the MAX3863 EV Kit

MAX3863 Evaluation Kit

Evaluates: MAX3863

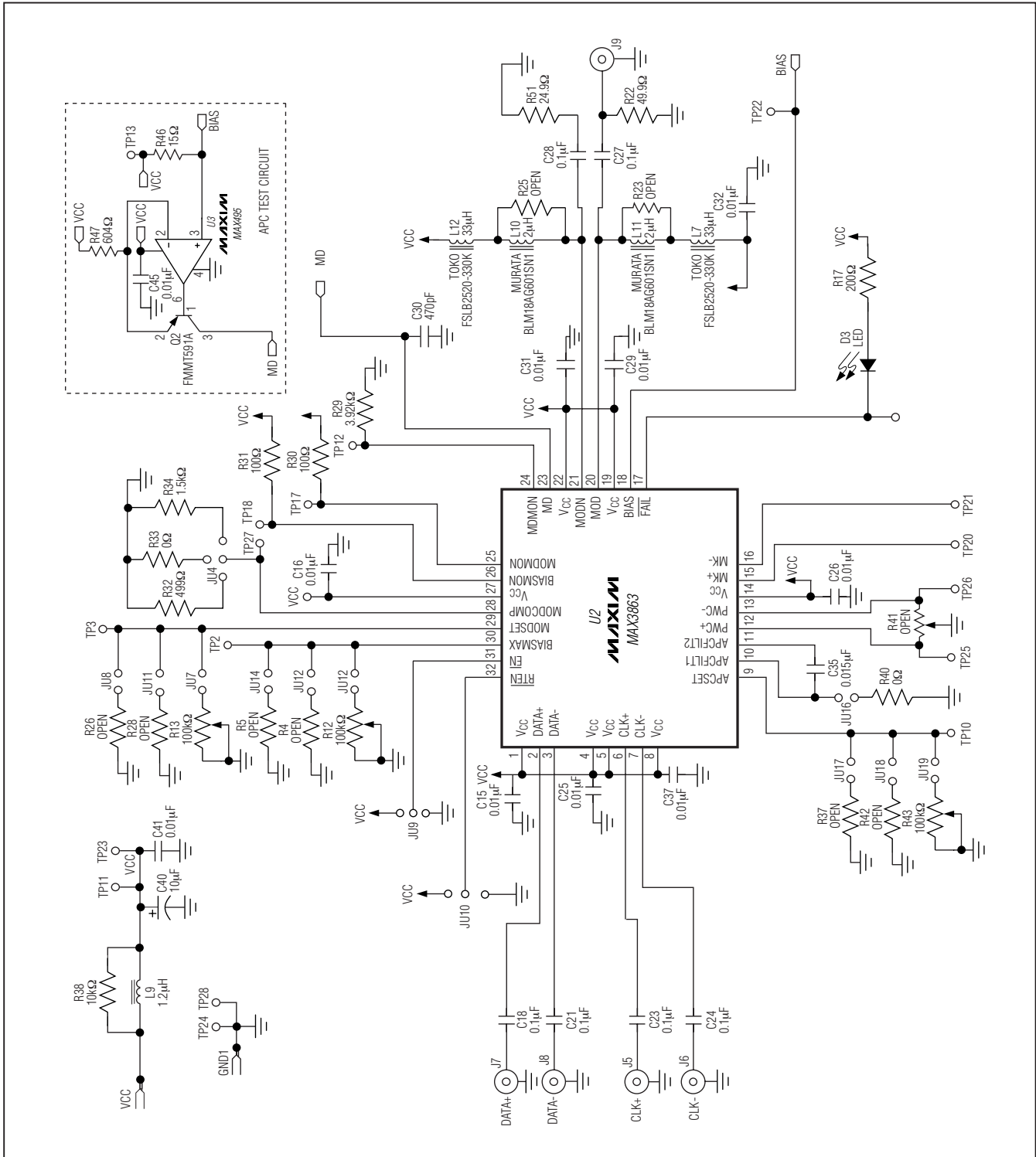

Figure 2. MAX3863 EV Kit Electrical Schematic

MAX3863 Evaluation Kit

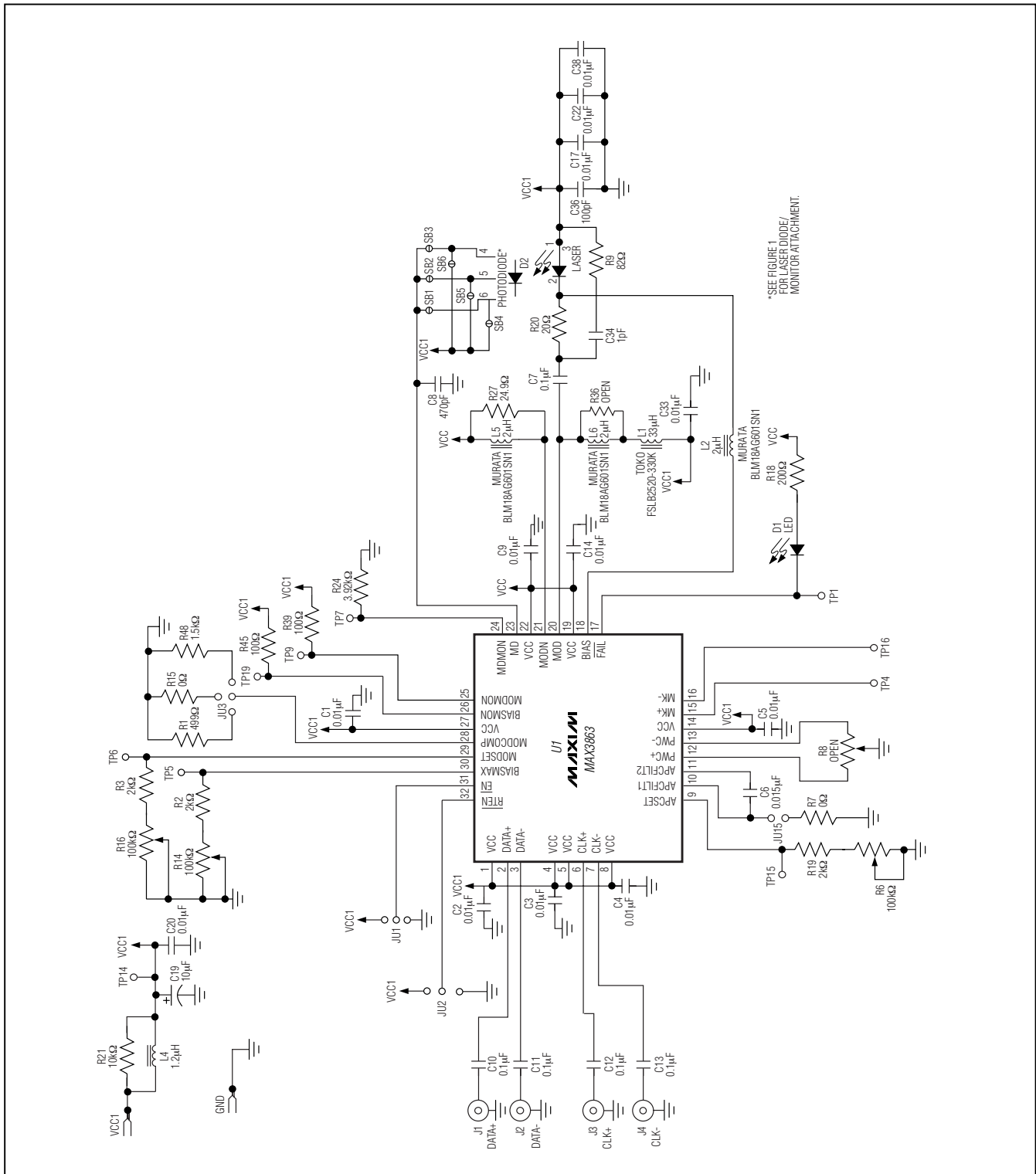

Figure 3. MAX3863 EV Kit Optical Schematic

MAX3863 Evaluation Kit

Evaluates: MAX3863

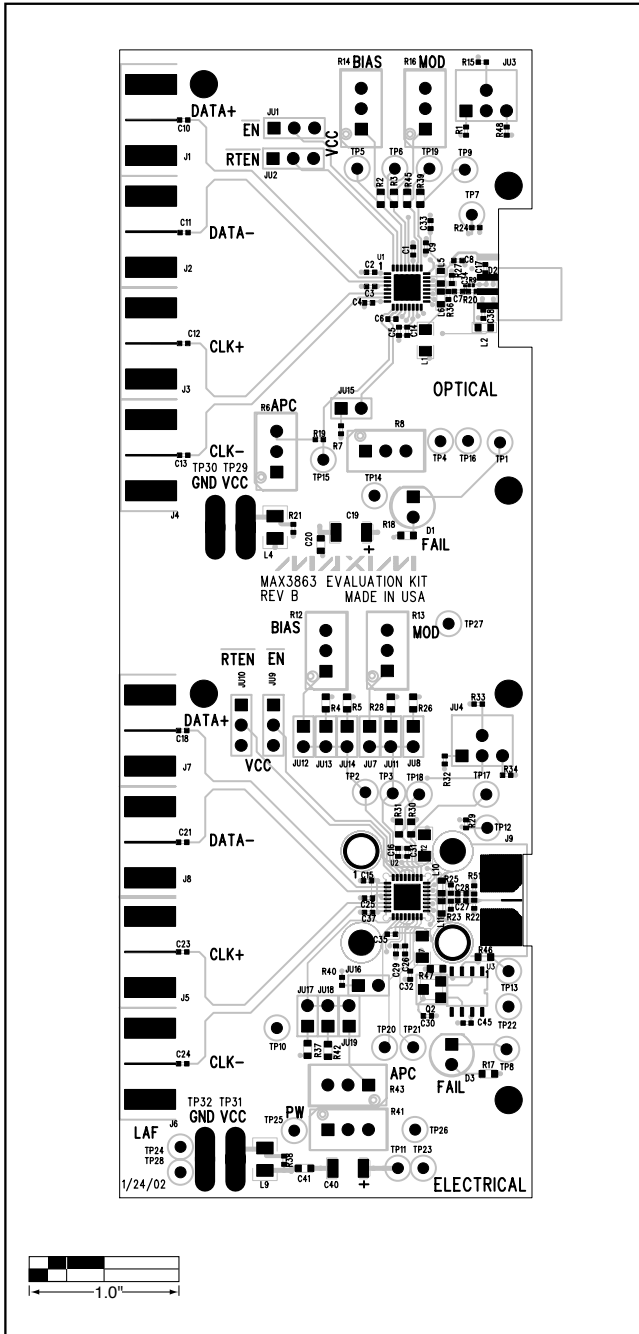

Figure 4. MAX3863 EV Kit Component Placement Guide—Component Side

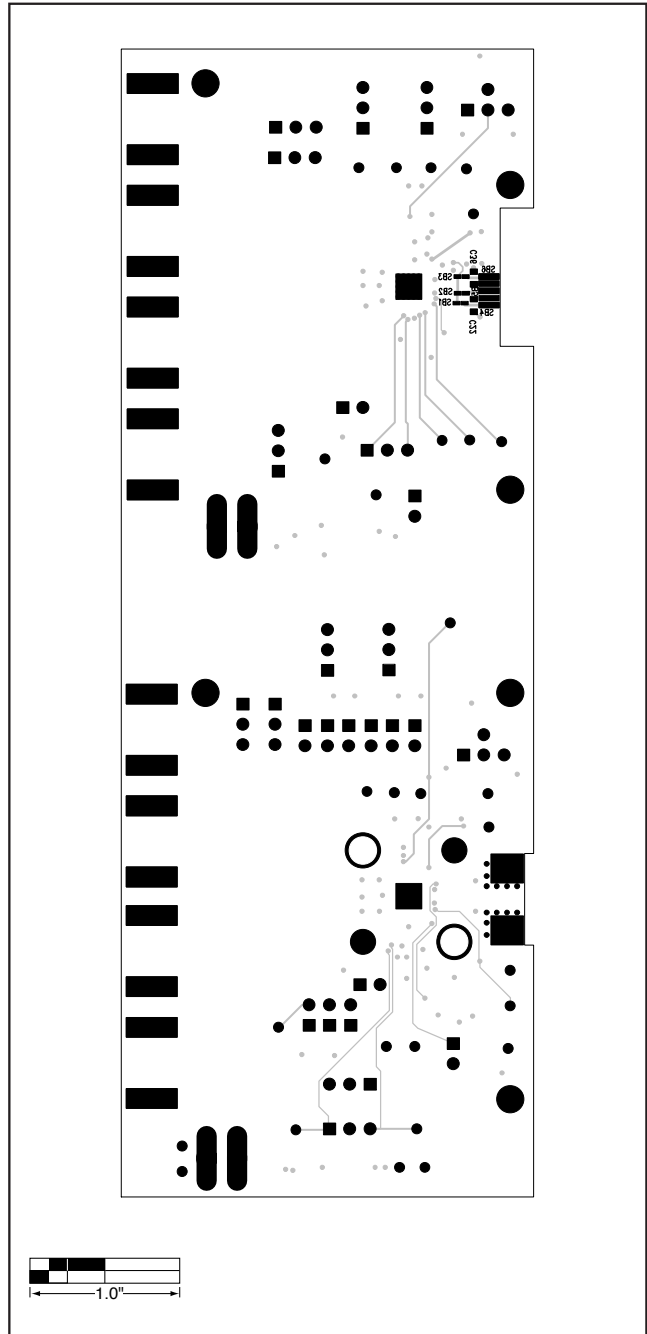

Figure 5. MAX3863 EV Kit PC Board Layout—Solder Side

MAX3863 Evaluation Kit

Evaluates: MAX3863

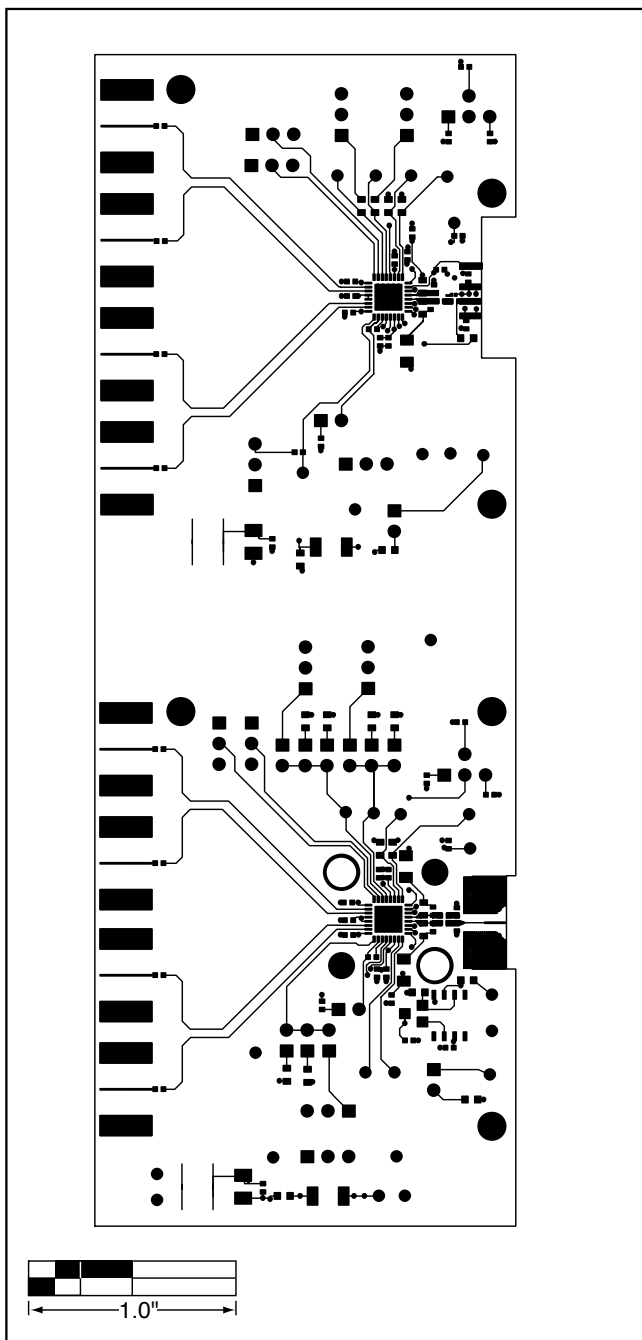

Figure 6. MAX3863 EV Kit PC Board Layout—Component Side

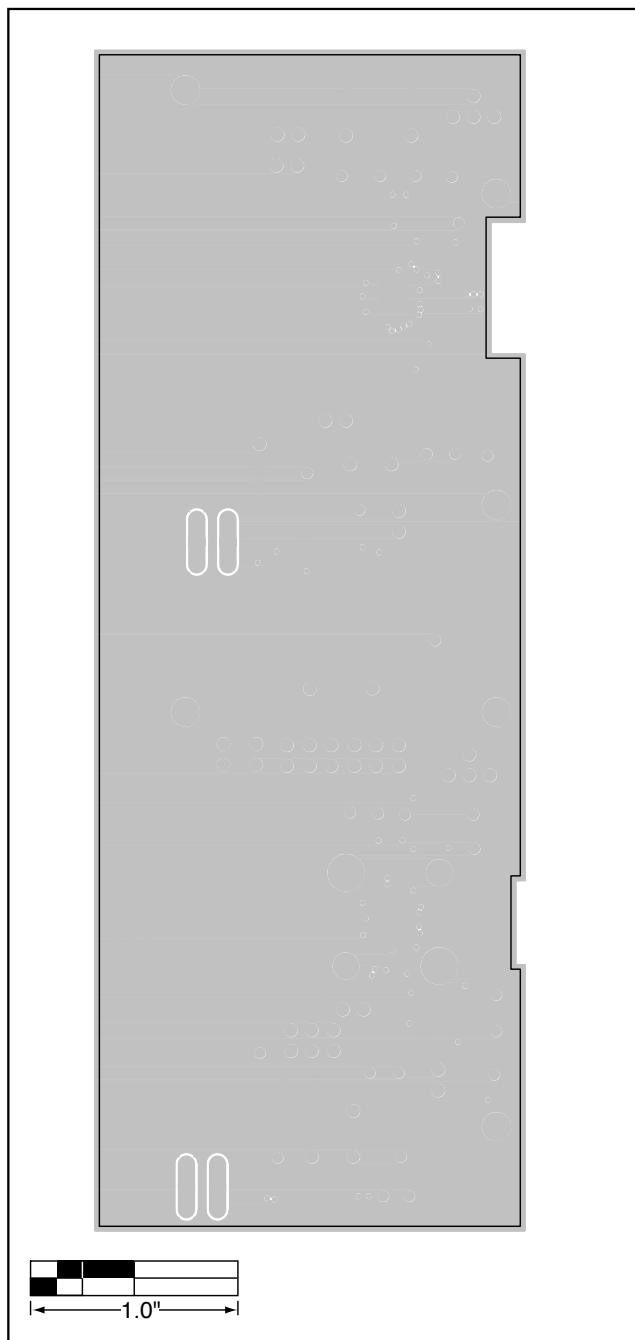

Figure 7. MAX3863 EV Kit PC Board Layout—Ground Plane

MAX3863 Evaluation Kit

Evaluates: MAX3863



Figure 8. MAX3863 EV Kit PC Board Layout—Power Plane

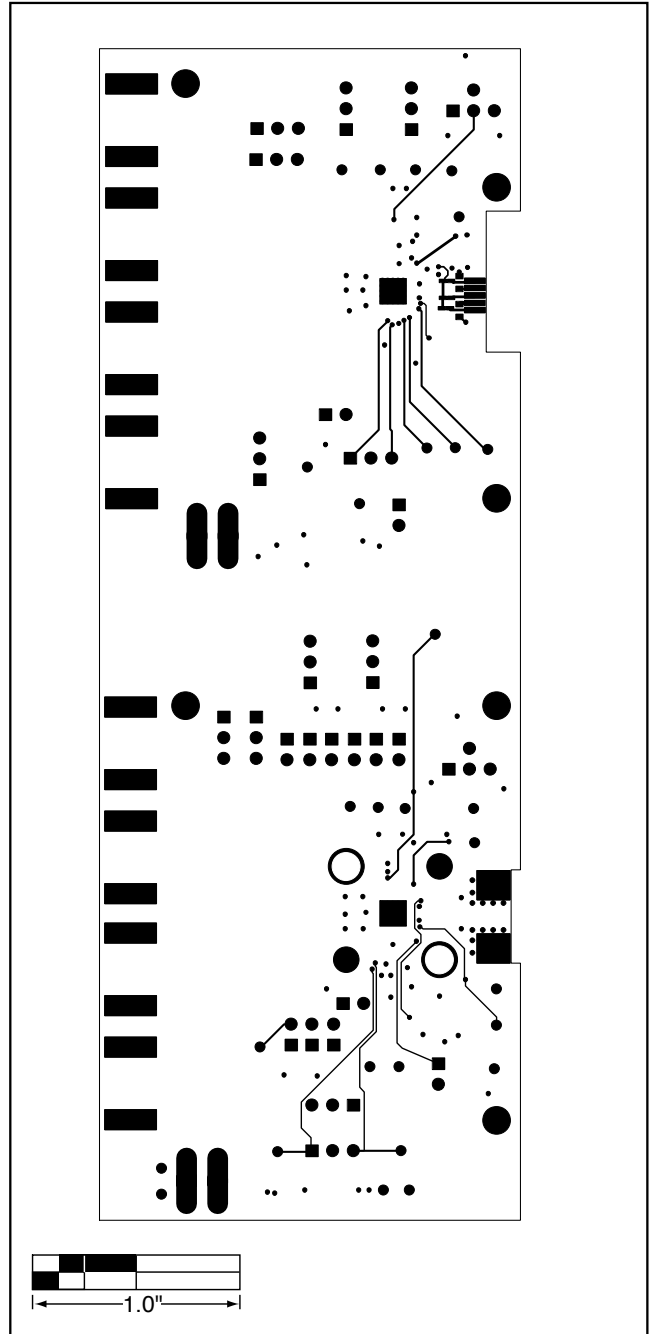

Figure 9. MAX3863 EV Kit PC Board Layout—Solder Side

Maxim cannot assume responsibility for use of any circuitry other than circuitry entirely embodied in a Maxim product. No circuit patent licenses are implied. Maxim reserves the right to change the circuitry and specifications without notice at any time.

11 _____ **Maxim Integrated Products, 120 San Gabriel Drive, Sunnyvale, CA 94086 408-737-7600**