

Features

Regulated Converters

- 2:1 Wide Input Voltage Range
- 1.6kVDC Isolation
- UL Certified
- Efficiency up to 89%
- Six-Sided Continuous Shield
- No Minimum Load Required

RP15-A

15 Watt
1"x1"
Single & Dual Output



Description

The RP15-A series are ultraminiature power DC/DC converters in a case half the size of industry standard 15W converters. Despite their small size, the RP15-A converters are fully specified devices with output currents up to 4 Amps, no minimum load, 1600VDC isolation and low ripple/noise figures. The outputs are also fully protected against short circuits, overcurrent and overvoltage. The RP15-A series will find many uses in applications where board space and/or board height is at a premium.

Selection Guide

Part Number	Input Voltage Range [VDC]	Output Voltage [VDC]	Output Current [mA]	Input ⁽¹⁾ Current [mA]	Efficiency ⁽¹⁾ typ. [%]	Max. Capacitive Load ⁽²⁾ [μF]
RP15-123.3SA ^(3,4)	9-18	3.3	4000	1310	84	12000
RP15-1205SA ^(3,4)	9-18	5	3000	1420	88	6000
RP15-1212SA ^(3,4)	9-18	12	1300	1512	86	1000
RP15-1215SA ^(3,4)	9-18	15	1000	1420	88	660
RP15-243.3SA ^(3,4)	18-36	3.3	4000	640	86	12000
RP15-2405SA ^(3,4)	18-36	5	3000	710	88	6000
RP15-2412SA ^(3,4)	18-36	12	1300	747	87	1000
RP15-2415SA ^(3,4)	18-36	15	1000	710	88	660
RP15-483.3SA ^(3,4)	36-75	3.3	4000	320	86	12000
RP15-4805SA ^(3,4)	36-75	5	3000	355	88	6000
RP15-4812SA ^(3,4)	36-75	12	1300	369	88	1000
RP15-4815SA ^(3,4)	36-75	15	1000	355	88	660
RP15-1205DA ^(3,4)	9-18	±5	±1500	1471	85	±3000
RP15-1212DA ^(3,4)	9-18	±12	±625	1437	87	±520
RP15-1215DA ^(3,4)	9-18	±15	±500	1420	88	±330
RP15-2405DA ^(3,4)	18-36	±5	±1500	735	85	±3000
RP15-2412DA ^(3,4)	18-36	±12	±625	710	88	±520
RP15-2415DA ^(3,4)	18-36	±15	±500	710	88	±330
RP15-4805DA ^(3,4)	36-75	±5	±1500	368	85	±3000
RP15-4812DA ^(3,4)	36-75	±12	±625	351	89	±520
RP15-4815DA ^(3,4)	36-75	±15	±500	355	88	±330



UL60950-1 Certified

Notes:

- Note1: Values at nominal input voltage and full load.
 Note2: Test by minimum Vin and constant resistor load.

Model Numbering

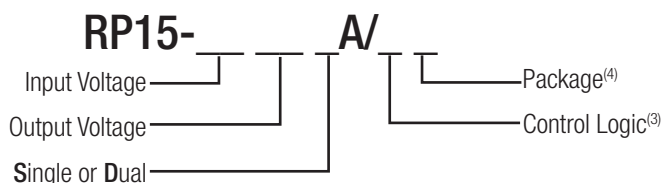

Ordering Examples

RP15-2405SA/P = 24V Input, 5V Output, Positive Logic CTRL pin and Trim pin fitted
 RP15-4805DA-HC = 48V Input, ±5V Output, Heat-sink fitted.

Notes:

- Note3: Standard part is without suffixes and Trim and CTRL pins are not fitted.
 add suffix "P" for CTRL function with positive logic (1=ON, 0=OFF) and trim pin for single output
 add suffix "N" for CTRL function with negative logic (0=ON, 1=OFF) and trim pin for single output
 Note4: add suffix -HC for premounted Heat-sink and clips

Specifications measured at $T_a = 25^\circ\text{C}$, nominal input voltage, full load otherwise noted

BASIC CHARACTERISTICS					
Parameter	Condition		Min.	Typ.	Max.
Input Voltage Range	nom. $V_{in} = 12\text{V}$ nom. $V_{in} = 24\text{V}$ nom. $V_{in} = 48\text{V}$		9VDC 18VDC 36VDC	12VDC 24VDC 48VDC	18VDC 36VDC 75VDC
Under Voltage Lockout (UVLO)	$V_{in} = 12\text{V}$	DC-DC ON DC-DC OFF		8VDC	9VDC
	$V_{in} = 24\text{V}$	DC-DC ON DC-DC OFF		14.5VDC	18VDC
	$V_{in} = 48\text{V}$	DC-DC ON DC-DC OFF		30.5VDC	36VDC
Input Filter					Pi-Type
Input Reflected Ripple Current ⁽⁵⁾	nominal V_{in} and full load			30mA _{p-p}	
Input Surge Voltage	$V_{in} = 12\text{V}$, 100ms max. $V_{in} = 24\text{V}$, 100ms max. $V_{in} = 48\text{V}$, 100ms max.				36VDC 50VDC 100VDC
Start-up time	Power up Remote ON/OFF				30ms 30ms
Operating Frequency Range			360kHz	400kHz	440kHz
Minimum Load	of full load		0%		
Optional Output Trim ⁽⁶⁾			±10.0%		
Ripple and Noise	measured by 20MHz bandwidth with a 1μF M/C X7R and 10μF T/C with a 1μF M/C X7R and 10μF T/C	Single 3.3V _{out} , 5V _{out} 12V _{out} , 15V _{out}		75mV _{p-p} 100mV _{p-p}	
	measured by 20MHz bandwidth with a 1μF M/C X7R and 10μF T/C	Dual		100mV _{p-p}	
Remote ON/OFF ⁽⁶⁾	Positive Logic	DC-DC ON DC-DC OFF	Open or $3.0 < V_r < 15\text{VDC}$ Short or $0 < V_r < 1.2\text{VDC}$		
	Negative Logic	DC-DC ON DC-DC OFF	Short or $0 < V_r < 1.2\text{VDC}$ Open or $3.0 < V_r < 15\text{VDC}$		
Input current of Remote pin (CTRL)				2.5mA	
			DC-DC OFF DC-DC ON	-0.5 mA	1.0mA

Notes:

Note5: Simulated source impedance of 12μH. 12μH inductor in series with +Vin.

Note6: The ON/OFF control function can be positive or negative logic. The pin voltage is referenced to -Vin pin.

If no suffix is specified, the control pin will be omitted

RP15-1205SA

Efficiency vs. Output Current

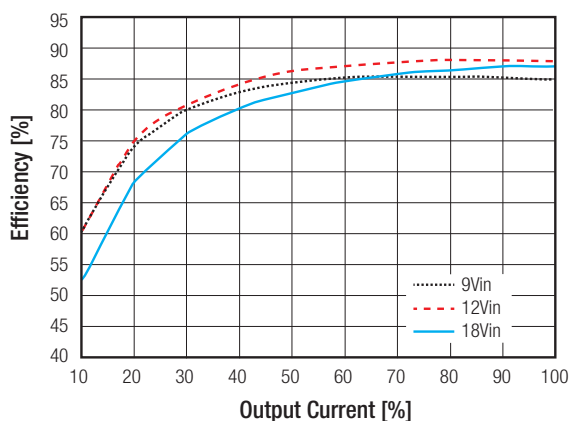

Efficiency vs. Input Voltage

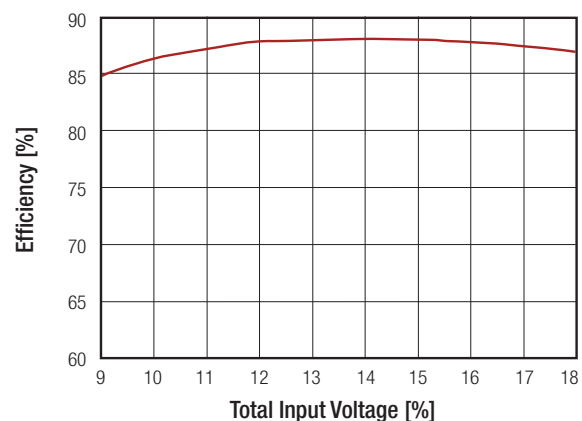

continued on next page

Specifications measured at Ta = 25°C, nominal input voltage, full load otherwise noted

RP15-2405SA

Efficiency vs. Output Current

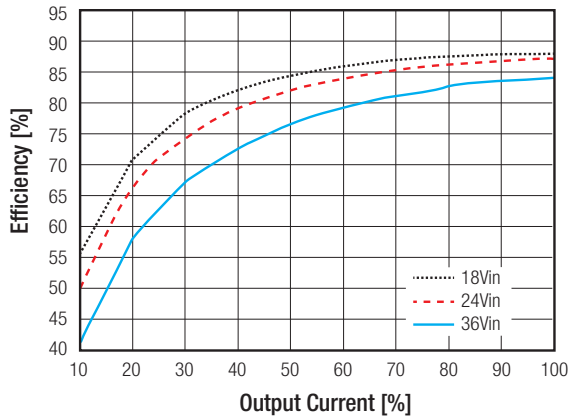

Efficiency vs. Input Voltage

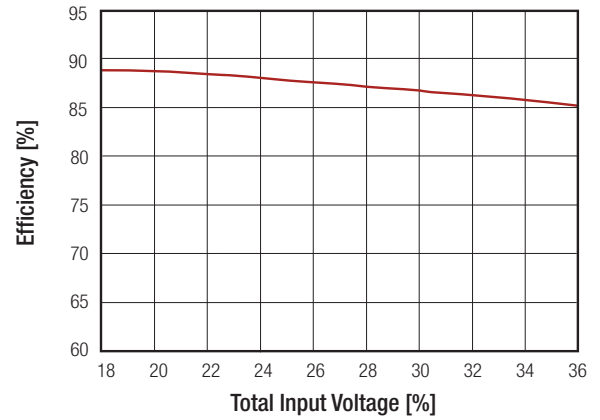

RP15-4805SA

Efficiency vs. Output Current

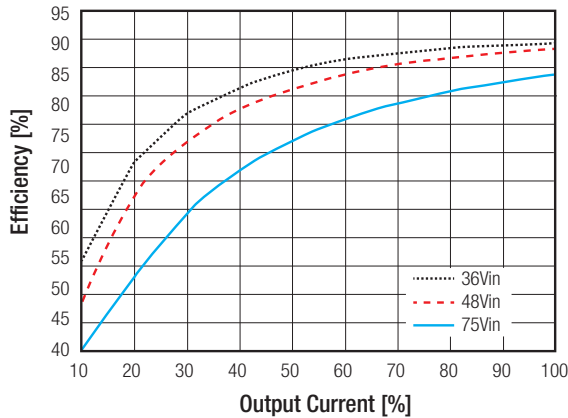

Efficiency vs. Input Voltage

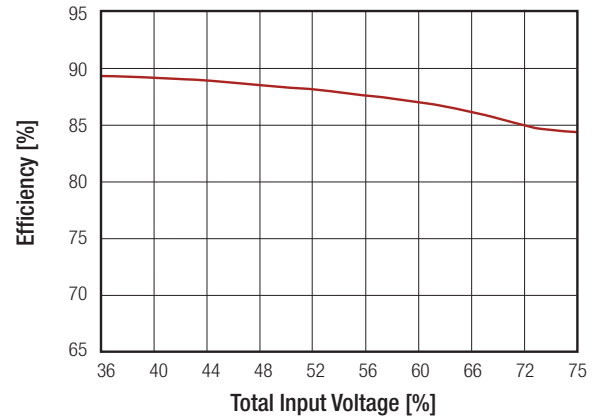

REGULATIONS

Parameter	Condition		Value
Output Voltage Accuracy			±1%
Output Trimming	Single		±10%
Line Voltage Regulation	Single		±0.2%
	Dual		±0.5%
Load Voltage Regulation	0% to 100% load	Single	±0.2%
		Dual	±1.0%
Cross Regulation	asymmetrical 25% <-> 100% load		±5%
Transient Response recovery time	25% load step change		250µs typ.

External Output Trimming

Output Voltage Trimming

Single output Powerline converters offer the feature of trimming the output voltage over a certain range around the nominal value by using external trim resistors. No general equation can be given for calculating the trim resistors, but the following trimtables give typical values for choosing these trimming resistors. If voltages between the given trim points are required, extrapolate between the two nearest given values to work out the resistor required or use a variable resistor to set the output voltage.

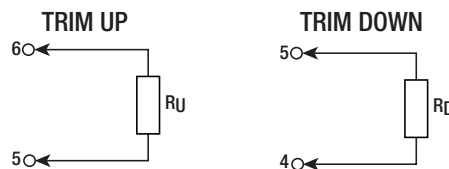

continued on next page

Specifications measured at $T_a = 25^\circ\text{C}$, nominal input voltage, full load otherwise noted

RP15-xx3.3A											
Trim up	1	2	3	4	5	6	7	8	9	10	%
V _{out} =	3.333	3.366	3.399	3.432	3.465	3.498	3.531	3.564	3.597	3.63	Volts
R _u =	385.07	191.51	126.99	94.73	75.37	62.47	53.25	46.34	40.96	36.66	kOhms
Trim down	1	2	3	4	5	6	7	8	9	10	%
V _{out} =	3.267	3.234	3.201	3.168	3.135	3.102	3.069	3.036	3.003	2.97	Volts
R _d =	116.72	54.78	34.13	23.81	17.62	13.49	10.54	8.32	6.60	5.23	kOhms
RP15-xx05A											
Trim up	1	2	3	4	5	6	7	8	9	10	%
V _{out} =	5.05	5.10	5.15	5.20	5.25	5.30	5.35	5.4	5.45	5.50	Volts
R _u =	253.45	125.70	83.12	61.82	49.05	40.53	34.45	29.89	26.34	23.50	kOhms
Trim down	1	2	3	4	5	6	7	8	9	10	%
V _{out} =	4.95	4.90	4.85	4.80	4.75	4.70	4.65	4.60	4.55	4.50	Volts
R _d =	248.34	120.59	78.01	56.71	43.94	35.42	29.34	24.78	21.23	18.39	kOhms
RP15-xx12A											
Trim up	1	2	3	4	5	6	7	8	9	10	%
V _{out} =	12.12	12.24	12.36	12.48	12.60	12.72	12.84	12.96	13.08	13.20	Volts
R _u =	203.22	99.06	64.33	46.97	36.56	29.61	24.65	20.93	18.04	15.72	kOhms
Trim down	1	2	3	4	5	6	7	8	9	10	%
V _{out} =	11.88	11.76	11.64	11.52	11.40	11.28	11.16	11.04	10.92	10.8	Volts
R _d =	776.56	380.72	248.78	182.81	143.22	116.83	97.98	83.85	72.85	64.06	kOhms
RP15-xx15A											
Trim up	1	2	3	4	5	6	7	8	9	10	%
V _{out} =	15.15	15.3	15.45	15.60	15.75	15.90	16.05	16.20	16.35	16.50	Volts
R _u =	161.56	78.22	50.45	36.56	28.22	22.67	18.70	15.72	13.41	11.56	kOhms
Trim down	1	2	3	4	5	6	7	8	9	10	%
V _{out} =	14.85	14.70	14.55	14.40	14.25	14.10	13.95	13.80	13.65	13.50	Volts
R _d =	818.22	401.56	262.67	193.22	151.56	123.78	103.94	89.06	77.48	68.22	kOhms

Specifications measured at Ta = 25°C, nominal input voltage, full load otherwise noted

PROTECTIONS

Parameter	Condition	Value	
Short Circuit Protection (SCP)		continuous, automatic recovery	
Over Voltage Protection (OVP)	Zener Diode Clamp	3.3Vout	3.7 - 5.4V
		5Vout	5.6 - 7.0V
		12Vout	13.5 - 19.6V
		15Vout	16.8 - 20.5V
Over Load Protection (OLP)	% of Iout rated	150% typ.	
Isolation Voltage	I/P to O/P	1.6kVDC/1 minute	
	I/P (O/P) to case	1.0kVDC/1 minute	
Isolation Resistance	500VDC	1GΩ min.	
Isolation Capacitance		1000pF max.	

Notes:

Note7: This power module is not internally fused. An input line fuse must always be used.

ENVIRONMENTAL

Parameter	Condition	Value
Operating Temperature Range	without derating	-40°C to +68°C
	with derating	-40°C to +105°C
Maximum Case Temperature		+105°C
Temperature Coefficient		±0.02%/°C max.
Thermal Impedance	Natural convection (20LFM)	18.2°C/Watt
	Natural convection (20LFM) with Heat sink	15.8°C/Watt
Operating Humidity		5% - 95% RH
Thermal Shock		MIL-STD-810F
Vibration		MIL-STD-810F
MTBF	MIL-HDBK-217F	1600 x 10 ³ hours
	Bellcore TR-NWT-000332 ⁽⁸⁾	1330 x 10 ³ hours

Derating Graph⁽⁹⁾

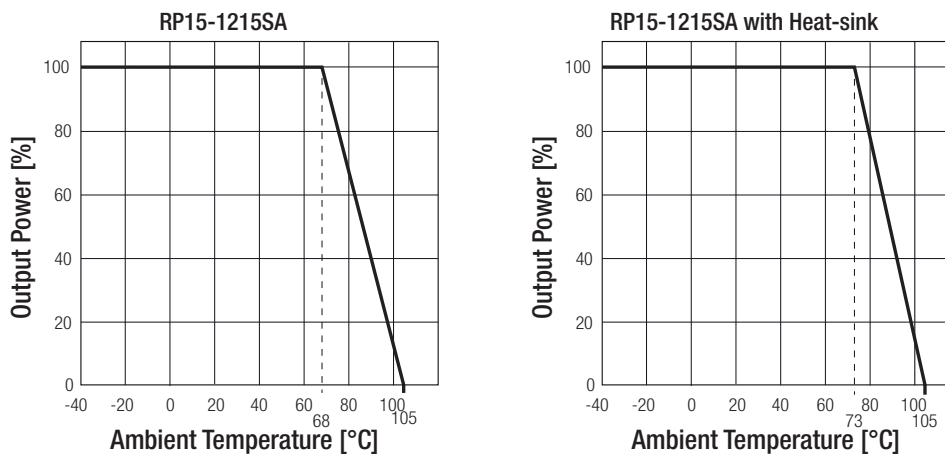

Notes:

Note8: BELLCORE TR-NWT-000332. Case I: 50% Stress, Temperature at 40°C.

MIL-HDBK 217F Notice 2. Ta = 25°C, full load, (Ground, Benign, controlled environment).

Note9: Derating graphs are valid only for the shown part numbers. If you need detailed derating-information about a part-number not shown here please contact our technical support service at techsupportAT@recom-power.com

Specifications measured at Ta = 25°C, nominal input voltage, full load otherwise noted

SAFETY AND CERTIFICATIONS		
Certificate Type (Safety)	Report / File Number	Standard
UL General Safety	E196683	UL60950-1 1st Ed.: 2003 C22.2 No. 60950 1st. Ed.: 2003
EMC Compliance		
EMC Compliance	Condition	Standard / Criterion
EMI Standard ⁽¹⁰⁾	with external filter	EN55022, Class A, Class B
ESD	Air ±8kV and Contact ± 6kV	EN61000-4-2, Criteria A
Radiated Immunity	10 V/m	EN61000-4-3, Criteria A
Fast Transient ⁽¹¹⁾	±2kV	EN61000-4-4, Criteria A
Surge ⁽¹¹⁾	±1kV	EN61000-4-5, Criteria A
Conducted Immunity	10 Vr.m.s	EN61000-4-6, Criteria A

Notes:

Note10: The standard modules meet EMI Class A or Class B with external components, see filter suggestions below.

Note11: An external input filter capacitor is required if the module has to meet EN61000-4-4, EN61000-4-5. The filter capacitor Recom suggests: Nippon chemi-con KY series, 220µF/100V.

EMI Filtering Class A

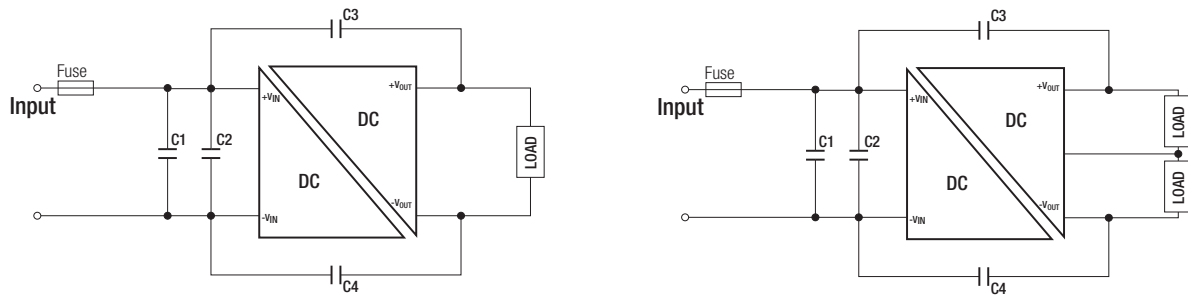

MODEL	C1	C2	C3/C4
RP15-12xxS_DA	10µF/25V 1812 MLCC	N/A	470pF/2kV 1808 MLCC
RP15-24xxS_DA	6.8µF/50V 1812 MLCC	6.8µF/50V 1812 MLCC	470pF/2kV 1808 MLCC
RP15-48xxS_DA	2.2µF/100V 1812 MLCC	2.2µF/100V 1812 MLCC	470pF/2kV 1808 MLCC

EMI Filtering Class B

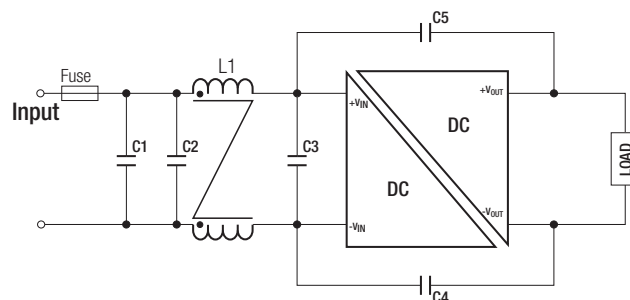

continued on next page

Specifications measured at Ta = 25°C, nominal input voltage, full load otherwise noted

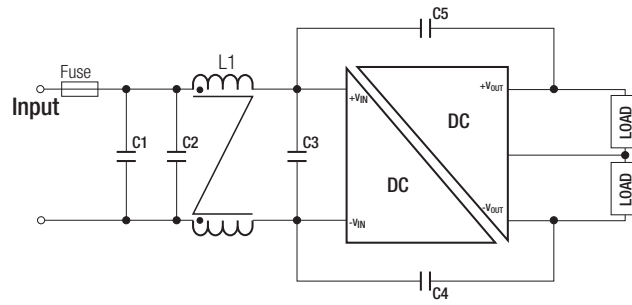

MODEL	C1	C2	C3	C4/C5	L1
RP15-12xxS_DA	10µF/25V 1812 MLCC	N/A	10µF/25V 1812 MLCC	470pF/2kV 1808 MLCC	CMC: 145µH ref: WE 482210002 ref: CMC-07
RP15-24xxS_DA	6.8µF/50V 1812 MLCC	N/A	6.8µF/50V 1812 MLCC	470pF/2kV 1808 MLCC	CMC: 325µH ref: WE 744290321 ref: CMC-06
RP15-48xxS_DA	2.2µF/100V 1812 MLCC	2.2µF/100V 1812 MLCC	2.2µF/100V 1812 MLCC	470pF/2kV 1808 MLCC	CMC: 325µH ref: WE 744290321 ref: CMC-06

DIMENSIONS and PHYSICAL CHARACTERISTICS

Parameter	Type	Value
Material	Case Base Potting	Nickel coated copper FR4 PCB Epoxy (UL94-V0)
Package Dimensions (LxWxH)	without Heat-sink with Heat-sink	25.4 x 25.4 x 9.9mm 31.4 x 25.4 x 16.5mm
Package Weight	without Heat-sink with Heat-sink	15g 21.44g

Dimension Drawing (mm)

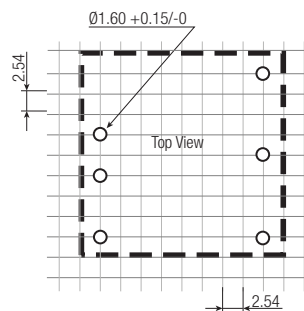
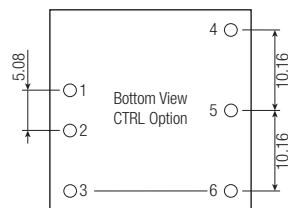
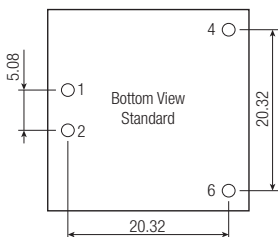
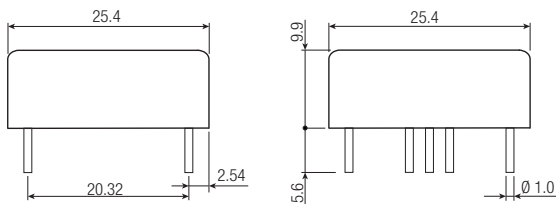
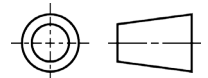

Pin Connections

Pin #	Single	Single /P or /N	Dual	Dual /P or /N
1	+Vin	+Vin	+Vin	+Vin
2	-Vin	-Vin	-Vin	-Vin
3	no Pin	CTRL	no Pin	CTRL
4	+Vout	+Vout	+Vout	+Vout
5	no Pin	Trim	Com	Com
6	-Vout	-Vout	-Vout	-Vout

Pin Pitch Tolerance ± 0.25 mm
Pin Dimension Tolerance ± 0.1 mm
XX.X ± 0.5 mm
XX.XX ± 0.25 mm

continued on next page

Specifications measured at $T_a = 25^\circ\text{C}$, nominal input voltage, full load otherwise noted

Dimension Drawing (mm) with Heat-sink

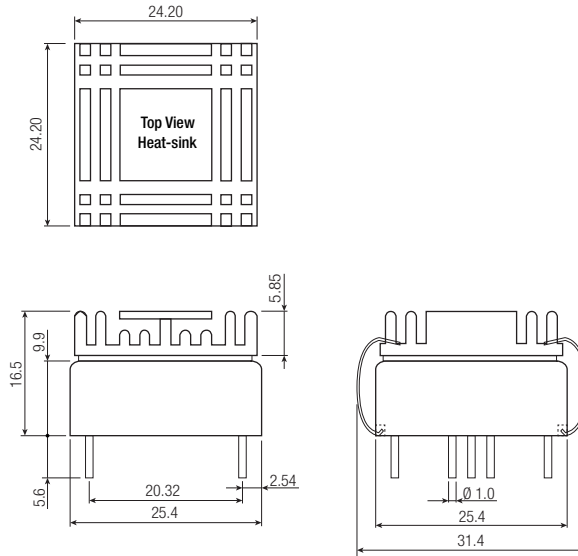

PACKAGING INFORMATION

Parameter	Type	Value
Packaging Quantity	without Heat-sink	Tube
	with Heat-sink	Tray
Storage Temperature Range		-55°C to +125°C
Storage Humidity		5% - 95% RH