

**XPT™ 650V IGBT
GenX3™ w/Diode**
**IXYA15N65C3D1
IXYP15N65C3D1**

$$V_{CES} = 650V$$

$$I_{C110} = 15A$$

$$V_{CE(sat)} \leq 2.5V$$

$$t_{fi(typ)} = 28ns$$

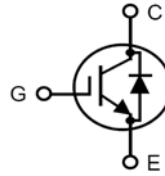
 Extreme Light Punch Through
IGBT for 20-60kHz Switching

Symbol	Test Conditions	Maximum Ratings	
V_{CES}	$T_J = 25^\circ C$ to $175^\circ C$	650	V
V_{CGR}	$T_J = 25^\circ C$ to $175^\circ C$, $R_{GE} = 1M\Omega$	650	V
V_{GES}	Continuous	± 20	V
V_{GEM}	Transient	± 30	V
I_{C25}	$T_C = 25^\circ C$	38	A
I_{C110}	$T_C = 110^\circ C$	15	A
I_{F110}	$T_C = 110^\circ C$	23	A
I_{CM}	$T_C = 25^\circ C$, 1ms	80	A
I_A	$T_C = 25^\circ C$	5	A
E_{AS}	$T_C = 25^\circ C$	100	mJ
SSOA	$V_{GE} = 15V$, $T_{VJ} = 150^\circ C$, $R_G = 20\Omega$	$I_{CM} = 30$	A
(RBSOA)	Clamped Inductive Load	@ $V_{CE} \leq V_{CES}$	
t_{sc}	$V_{GE} = 15V$, $V_{CE} = 360V$, $T_J = 150^\circ C$	8	μs
(SCSOA)	$R_G = 82\Omega$, Non Repetitive		
P_C	$T_C = 25^\circ C$	200	W
T_J		-55 ... +175	$^\circ C$
T_{JM}		175	$^\circ C$
T_{stg}		-55 ... +175	$^\circ C$
T_L	Maximum Lead Temperature for Soldering	300	$^\circ C$
T_{SOLD}	1.6 mm (0.062in.) from Case for 10s	260	$^\circ C$
M_d	Mounting Torque (TO-220)	1.13/10	Nm/lb.in
F_C	Mounting Force (TO-263)	10..65 / 2.2..14.6	N/lb
Weight	TO-263	2.5	g
	TO-220	3.0	g

TO-263 AA (IXYA)

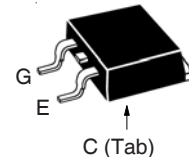

TO-220AB (IXYP)

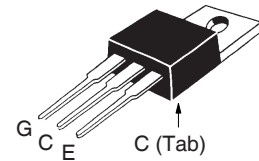

G = Gate C = Collector
E = Emitter Tab = Collector

Features

- Optimized for 20-60kHz Switching
- Square RBSOA
- Avalanche Rated
- Anti-Parallel Fast Diode
- Short Circuit Capability
- International Standard Packages

Advantages

- High Power Density
- Extremely Rugged
- Low Gate Drive Requirement

Applications

- Power Inverters
- UPS
- Motor Drives
- SMPS
- PFC Circuits
- Battery Chargers
- Welding Machines
- Lamp Ballasts
- High Frequency Power Inverters

Symbol	Test Conditions ($T_J = 25^\circ C$, Unless Otherwise Specified)	Characteristic Values		
		Min.	Typ.	Max.
BV_{CES}	$I_C = 250\mu A$, $V_{GE} = 0V$	650		V
$V_{GE(th)}$	$I_C = 250\mu A$, $V_{CE} = V_{GE}$	3.5		V
I_{CES}	$V_{CE} = V_{CES}$, $V_{GE} = 0V$ $T_J = 150^\circ C$			10 μA 400 μA
I_{GES}	$V_{CE} = 0V$, $V_{GE} = \pm 20V$			± 100 nA
$V_{CE(sat)}$	$I_C = 15A$, $V_{GE} = 15V$, Note 1 $T_J = 150^\circ C$	1.96 2.45		2.50 V V

Symbol Test Conditions		Characteristic Values		
(T _J = 25°C Unless Otherwise Specified)		Min.	Typ.	Max.
g_{fs}	I _C = 15A, V _{CE} = 10V, Note 1	5.0	8.5	S
C_{ies}	V _{CE} = 25V, V _{GE} = 0V, f = 1MHz		583	pF
C_{oes}				
C_{res}				
Q_{g(on)}	I _C = 15A, V _{GE} = 15V, V _{CE} = 0.5 • V _{CES}		19	nC
Q_{ge}				
Q_{gc}				
t_{d(on)}	Inductive load, T _J = 25°C I _C = 15A, V _{GE} = 15V V _{CE} = 400V, R _G = 20Ω Note 2		15	ns
t_{ri}				
E_{on}				
t_{d(off)}				
t_{fi}				
E_{off}	0.23	0.40	mJ	
t_{d(on)}	Inductive load, T _J = 150°C I _C = 15A, V _{GE} = 15V V _{CE} = 400V, R _G = 20Ω Note 2		15	ns
t_{ri}				
E_{on}				
t_{d(off)}				
t_{fi}				
E_{off}	0.24		mJ	
R_{thJC}	TO-220	0.50	0.75 °C/W	
R_{thCS}			°C/W	

Reverse Diode (FRED)

Symbol Test Conditions		Characteristic Values		
(T _J = 25°C, Unless Otherwise Specified)		Min.	Typ.	Max.
V_F	I _F = 10A, V _{GE} = 0V, Note 1 T _J = 125°C		1.7	3.0 V
I_{RM}	I _F = 12A, V _{GE} = 0V, -di _F /dt = 100A/μs, V _R = 100V, T _J = 125°C		2.5	A
t_{rr}				
t_{rr}	I _F = 1A, V _{GE} = 0V, -di _F /dt = 100A/μs, V _R = 30V		30	ns
R_{thJC}				1.85 °C/W

Notes:

1. Pulse test, t ≤ 300μs, duty cycle, d ≤ 2%.
2. Switching times & energy losses may increase for higher V_{CE} (clamp), T_J or R_G.

PRELIMINARY TECHNICAL INFORMATION

The product presented herein is under development. The Technical Specifications offered are derived from a subjective evaluation of the design, based upon prior knowledge and experience, and constitute a "considered reflection" of the anticipated result. IXYS reserves the right to change limits, test conditions, and dimensions without notice.

TO-263 Outline

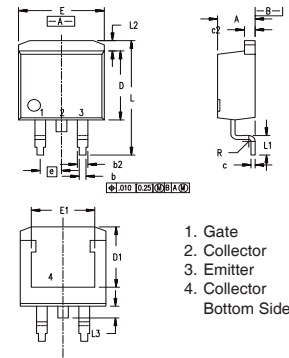

Dim.	Millimeter		Inches	
	Min.	Max.	Min.	Max.
A	4.06	4.83	.160	.190
b	0.51	0.99	.020	.039
b2	1.14	1.40	.045	.055
c	0.40	0.74	.016	.029
c2	1.14	1.40	.045	.055
D	8.64	9.65	.340	.380
D1	8.00	8.89	.280	.320
E	9.65	10.41	.380	.405
E1	6.22	8.13	.270	.320
e	2.54	BSC	.100	BSC
L	14.61	15.88	.575	.625
L1	2.29	2.79	.090	.110
L2	1.02	1.40	.040	.055
L3	1.27	1.78	.050	.070
L4	0	0.13	0	.005

TO-220 Outline

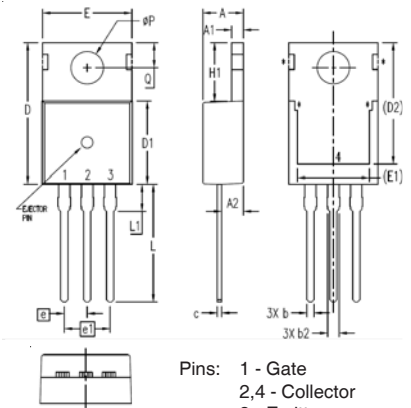

- Pins:** 1 - Gate
2,4 - Collector
3 - Emitter

SYM	INCHES		MILLIMETERS	
	MIN	MAX	MIN	MAX
A	.169	.185	4.30	4.70
A1	.047	.055	1.20	1.40
A2	.079	.106	2.00	2.70
b	.024	.039	0.60	1.00
b2	.045	.057	1.15	1.45
c	.014	.026	0.35	0.65
D	.587	.626	14.90	15.90
D1	.335	.370	8.50	9.40
(D2)	.500	.531	12.70	13.50
E	.382	.406	9.70	10.30
(E1)	.283	.323	7.20	8.20
e	.100 BSC		2.54 BSC	
e1	.200 BSC		5.08 BSC	
H1	.244	.268	6.20	6.80
L	.492	.547	12.50	13.90
L1	.110	.154	2.80	3.90
∅P	.134	.150	3.40	3.80
Q	.106	.126	2.70	3.20

IXYS Reserves the Right to Change Limits, Test Conditions, and Dimensions.

IXYS MOSFETs and IGBTs are covered by one or more of the following U.S. patents:	4,835,592	4,931,844	5,049,961	5,237,481	6,162,665	6,404,065 B1	6,683,344	6,727,585	7,005,734 B2	7,157,338B2
	4,860,072	5,017,508	5,063,307	5,381,025	6,259,123 B1	6,534,343	6,710,405 B2	6,759,692	7,063,975 B2	
	4,881,106	5,034,796	5,187,117	5,486,715	6,306,728 B1	6,583,505	6,710,463	6,771,478 B2	7,071,537	

Fig. 1. Output Characteristics @ $T_J = 25^\circ\text{C}$

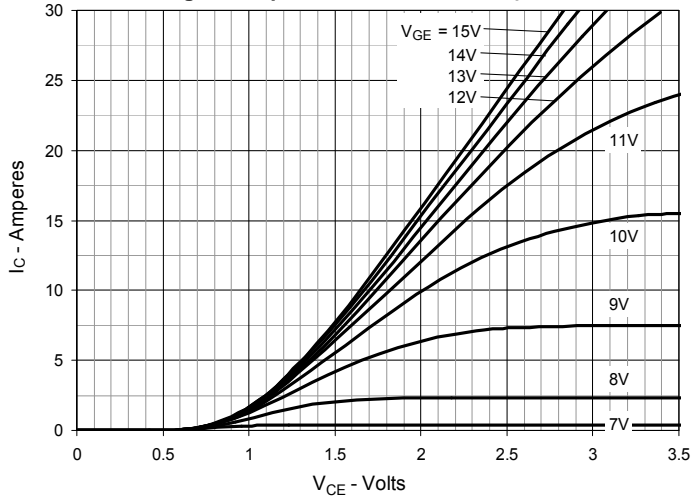

Fig. 2. Extended Output Characteristics @ $T_J = 25^\circ\text{C}$

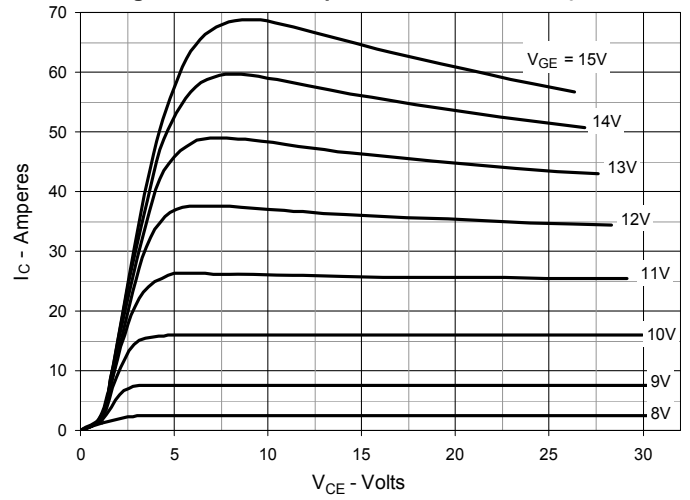

Fig. 3. Output Characteristics @ $T_J = 150^\circ\text{C}$

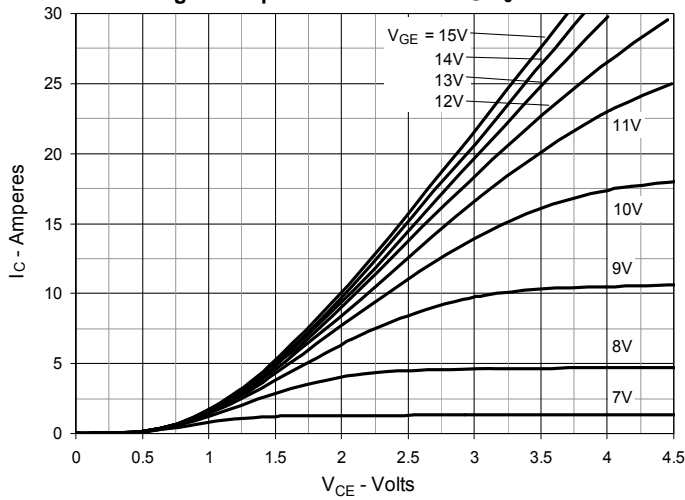

Fig. 4. Dependence of $V_{CE(sat)}$ on Junction Temperature

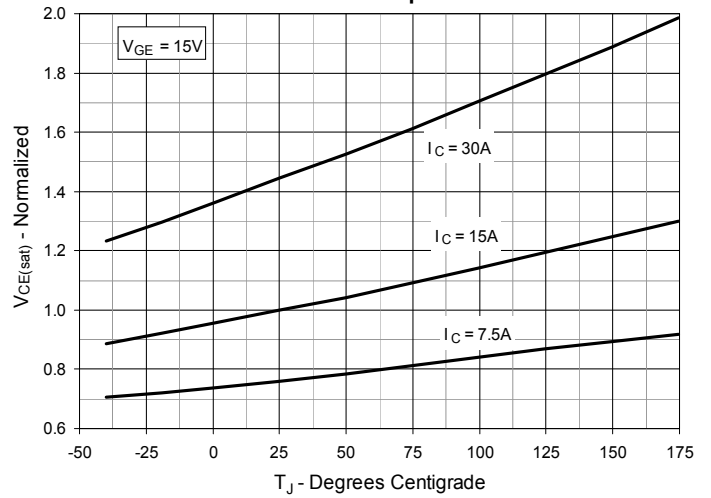

Fig. 5. Collector-to-Emitter Voltage vs. Gate-to-Emitter Voltage

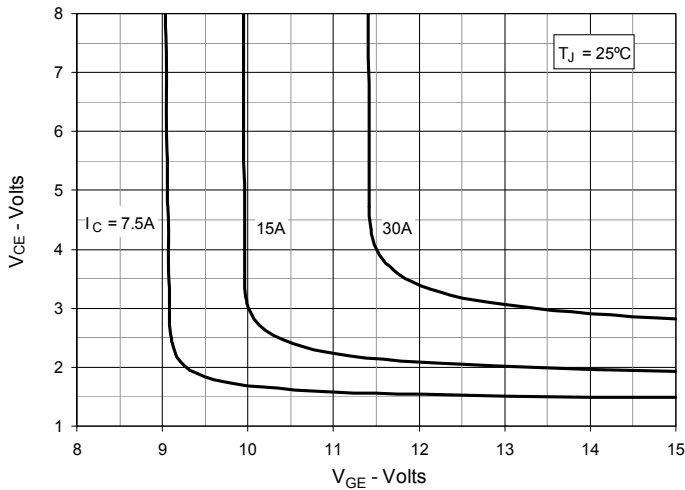

Fig. 6. Input Admittance

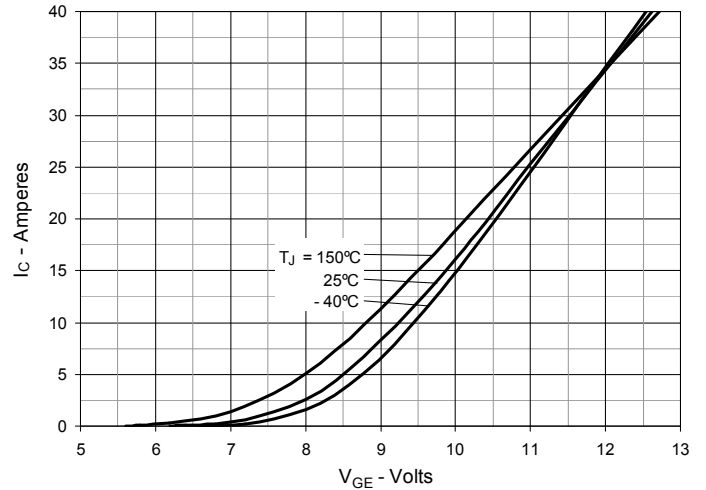

Fig. 7. Transconductance

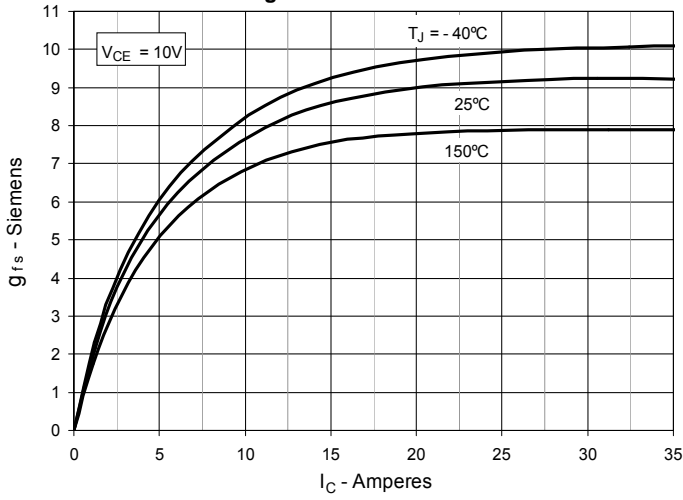

Fig. 8. Gate Charge

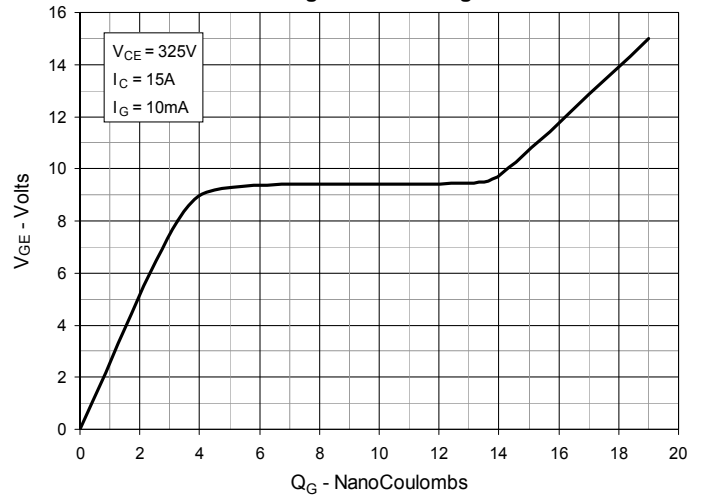

Fig. 9. Capacitance

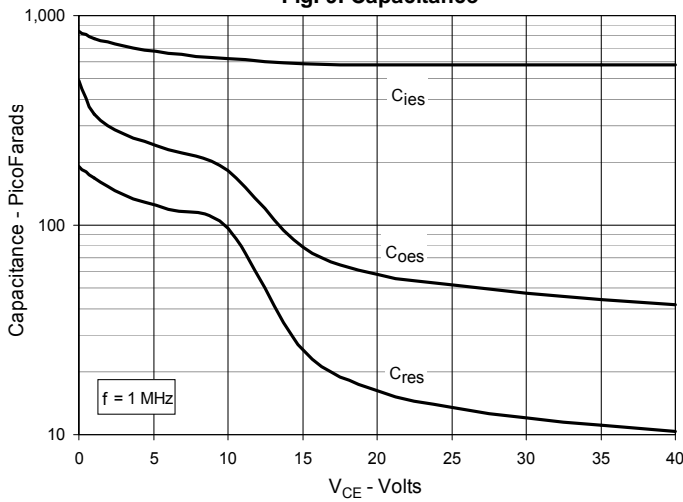

Fig. 10. Reverse-Bias Safe Operating Area

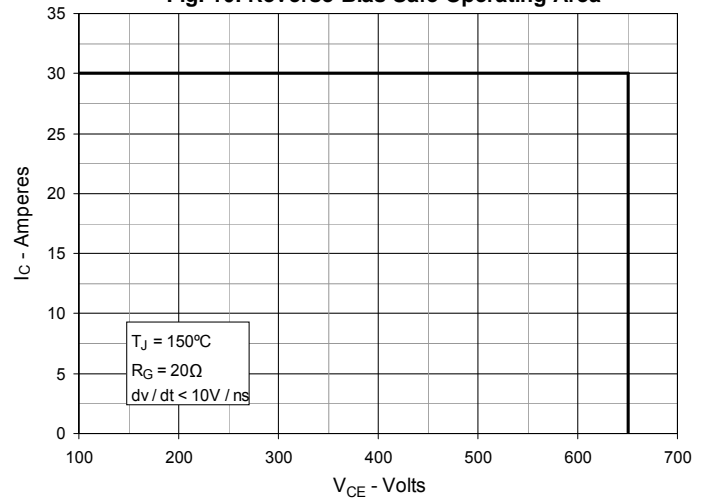

Fig. 11. Maximum Transient Thermal Impedance

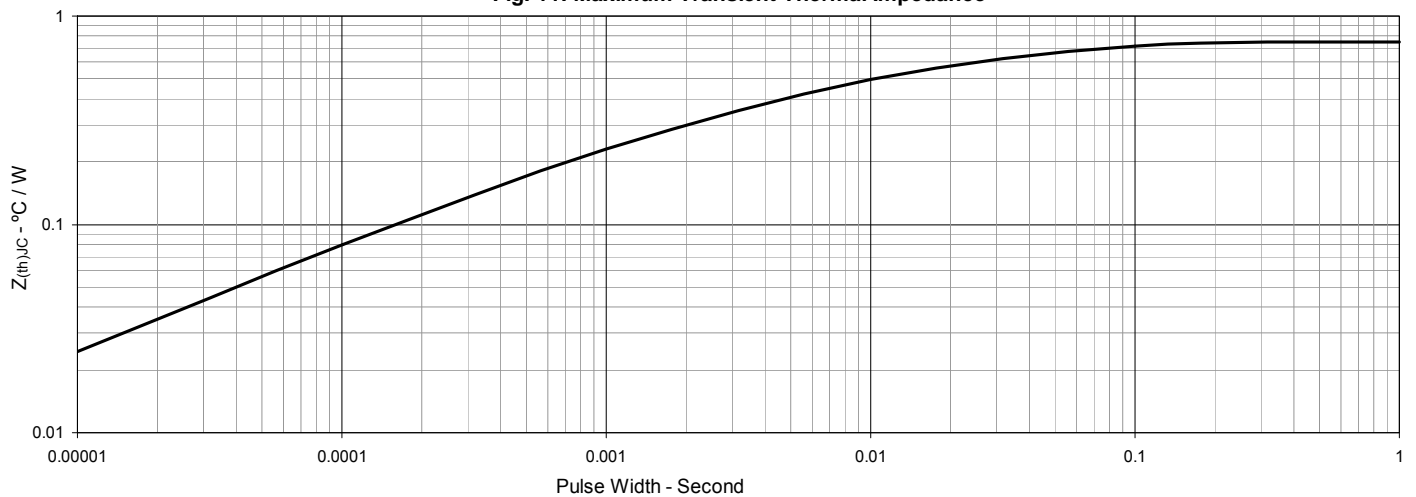

Fig. 12. Inductive Switching Energy Loss vs. Gate Resistance

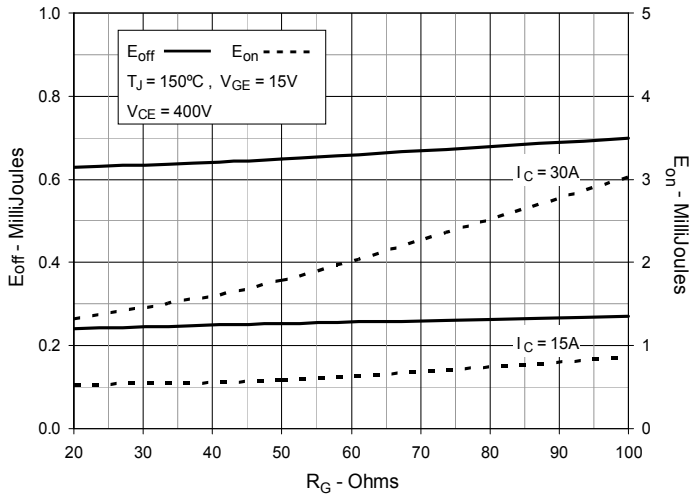

Fig. 13. Inductive Switching Energy Loss vs. Collector Current

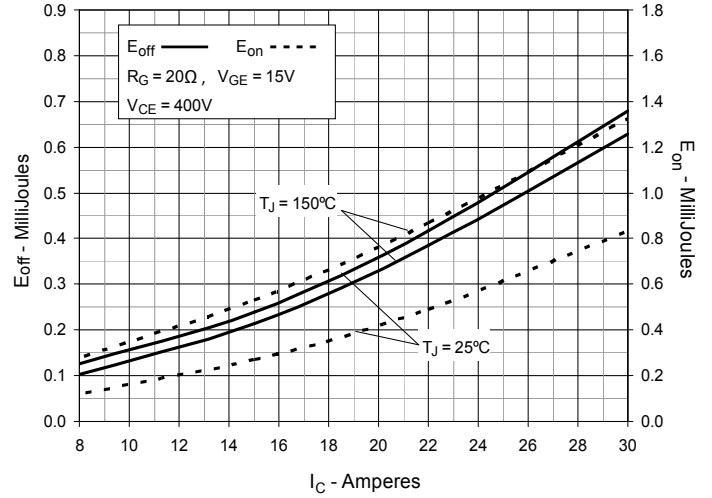

Fig. 14. Inductive Switching Energy Loss vs. Junction Temperature

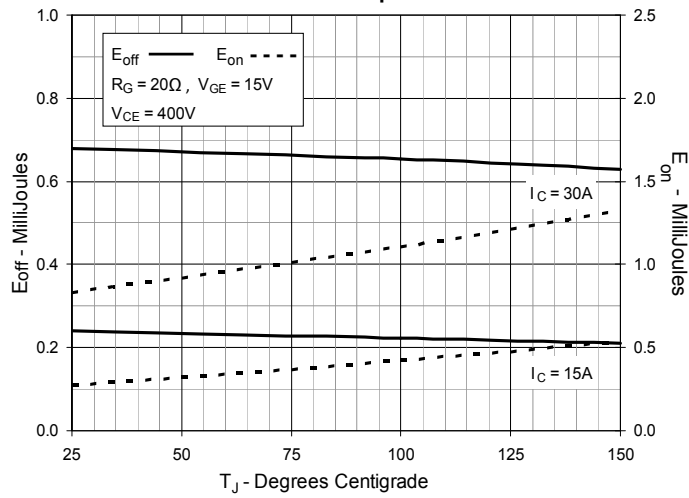

Fig. 15. Inductive Turn-off Switching Times vs. Gate Resistance

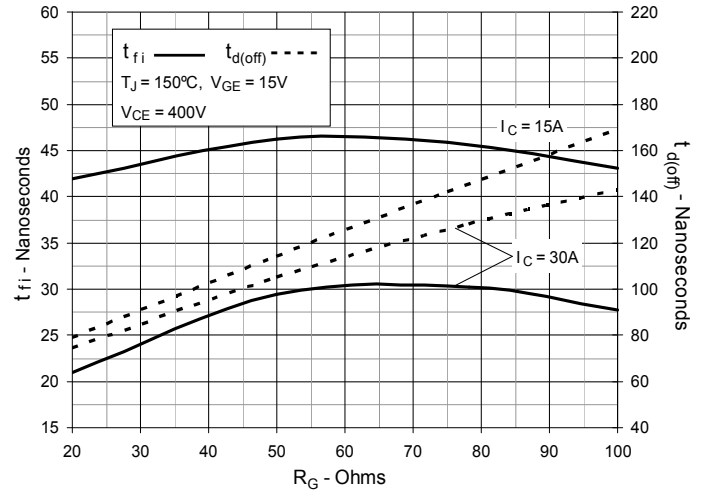

Fig. 16. Inductive Turn-off Switching Times vs. Collector Current

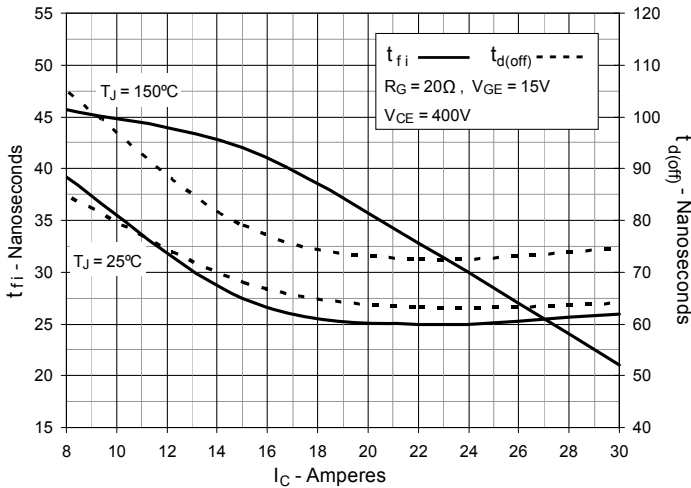

Fig. 17. Inductive Turn-off Switching Times vs. Junction Temperature

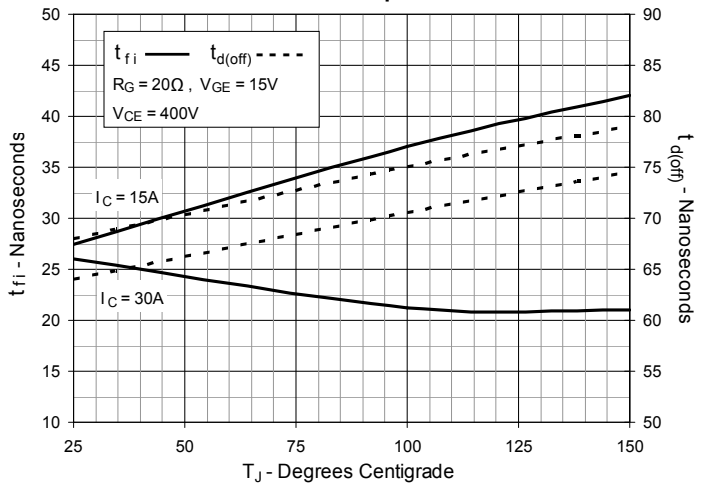

Fig. 18. Inductive Turn-on Switching Times vs. Gate Resistance

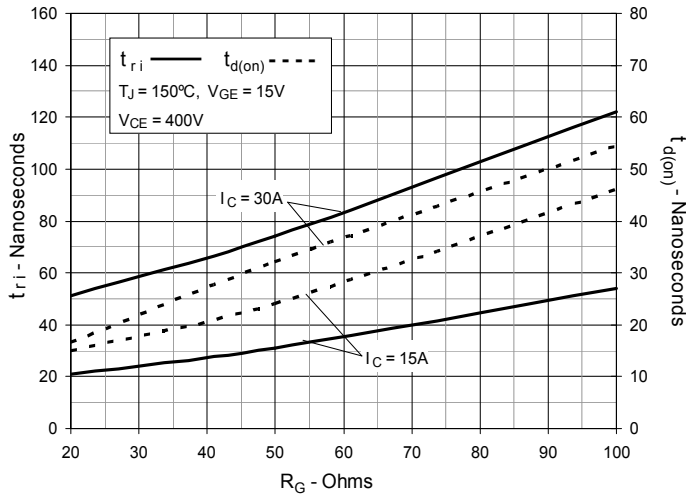

Fig. 19. Inductive Turn-on Switching Times vs. Collector Current

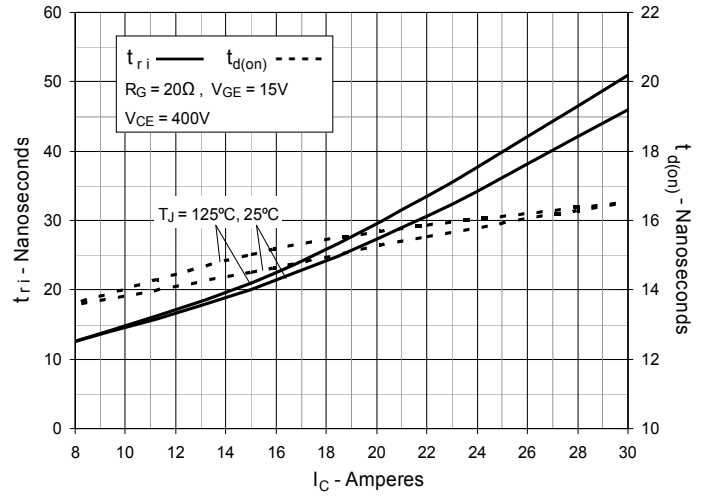

Fig. 20. Inductive Turn-on Switching Times vs. Junction Temperature

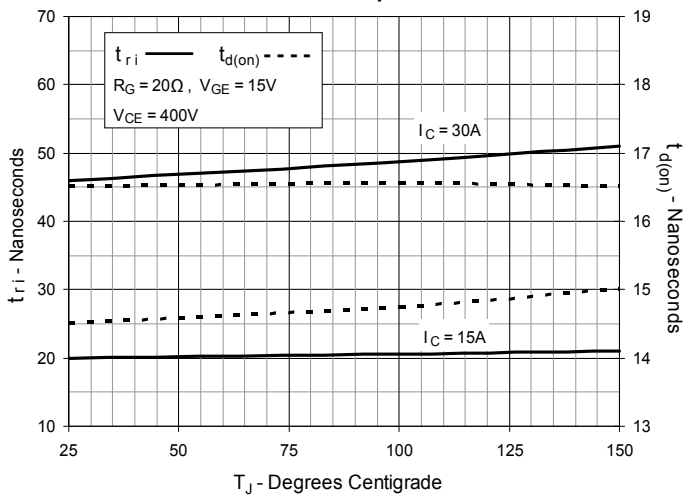

Fig. 21. Maximum Transient Impedance for Diode

