

SMDA03-6 THRU SMDA24-6 TVS ARRAY SERIES



Description

The SMDAXX-6 series of TVS array have been designed to provide unidirectional protection for sensitive electronics from damage due to voltage transients caused by electrostatic discharge (ESD), electrical fast transients (EFT), lightning and other voltage-induced transient events. The device can be used to protect combinations of six unidirectional lines.

Schematic & Pin Configuration

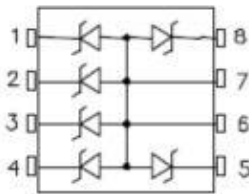

Features

- Protects 3.3, 5, 12, 15, 24 V Components
- Unidirectional
- Provides Electrically Isolated Protection
- 300 W @ 8/20 μ s
- Protects 6 Lines
- SO-8 Packaging
- This is a Pb – Free Device
- All SMC parts are traceable to the wafer lot
- Additional testing can be offered upon request

Mechanical Characteristics

- SO-8 Surface Mount Package
- Approximate Weight: 0.1 grams
- PIN #1 Indicator: DOT on top of package
- Packaging: Tubes or Tape & Reel per EIA Standard 481

Application

- RS-232 & RS-422 Data Lines
- Microprocessor Based Equipment
- Notebooks, Desktops, & Servers
- LAN/WAN Equipment
- Serial and Parallel Port
- Peripherals

Absolute Maximum Ratings:

Parameter	Symbol	Value	Units
Peak Pulse Power, 8/20 μ s Wave shape	P	300	W
Operating Temperature	T _J	-55 to +125	°C
Storage Temperature	T _{stg}	-55 to +150	°C
Lead Soldering Temperature	T _L	260 (10 Sec.)	°C

Electrical Characteristics@25°C

Part Number	Stand-off Voltage V_{wm} (V) Max	Breakdown Voltage V_{BR} @1mA (V) Min	Clamping Voltage V_c @ 1 A (V) Max	Leakage Current I_R @ V_{wm} (uA) Max	Capacitance (f = 1MHz) C @ 0V (pF) Max	Temperature Coefficient of V_{BR} a(V_{BR}) mv/°C Max
SMDA03-6	3.3	4	7	200	800	-3
SMDA05-6	5.0	6	9.8	20	550	3
SMDA12-6	12.0	13.3	19	1	185	10
SMDA15-6	15.0	16.7	24	1	140	13
SMDA24-6	24.0	26.7	43	1	90	30

Ratings and Characteristics Curves

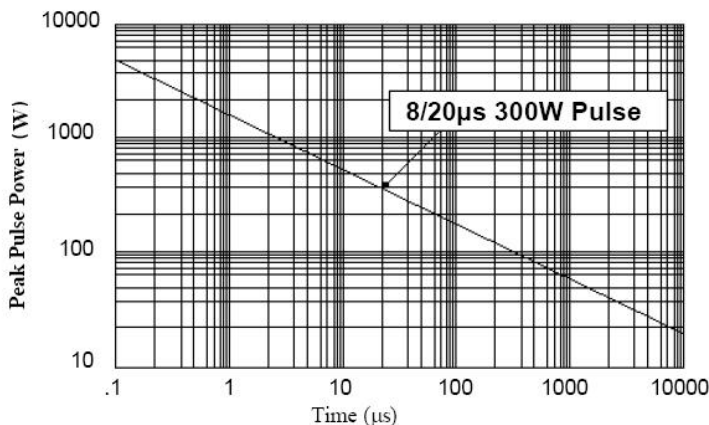

Figure 1. Peak Pulse Power Vs Pulse Time (µs)

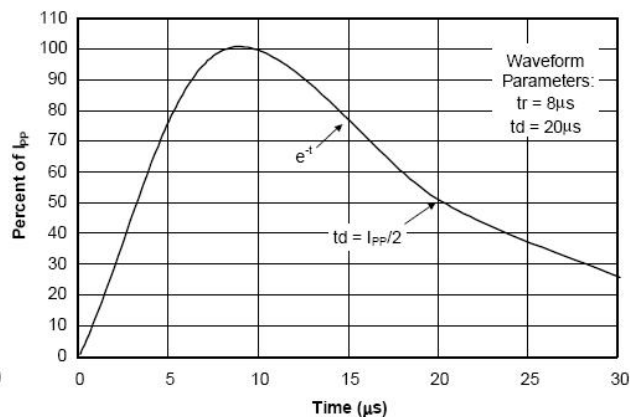

Figure 2. Pulse Wave Form

Ordering Information

Device	Package	Shipping
SMDA03-6 THRU SMDA24-6	SO-8 (Pb-Free)	2500pcs / reel

For information on tape and reel specifications, including part orientation and tape sizes, please refer to our tape and reel packaging specification.

Marking Diagram

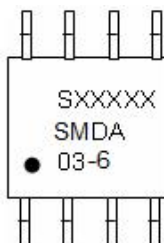

Where XXXXX is YYWWL

SMDA03-6 = Part Number
S = S
YY = Year
WW = Week
L = Lot Number

Cautions: Molding resin
Epoxy resin UL:94V-0

Circuit Diagram

The SMDAx-6 is designed to protect up to 6 data or I/O lines operating at 5 volts. They are unidirectional devices and may be used on lines where the signal polarities are above ground (i.e. 0 to 5V).

The devices are connected as follows:

- ✓ Pins 1, 2, 3, 4, 5 and 8 are connected to the lines that are to be protected. Pins 6 and 7 are connected to ground. The ground connections should be made directly to the ground plane for best results. The path length is kept as short as possible to reduce the effects of parasitic inductance in the board traces.

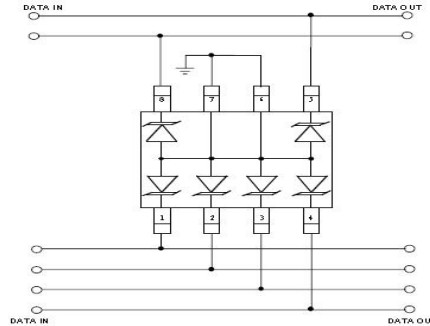

Mechanical Dimensions SO-8

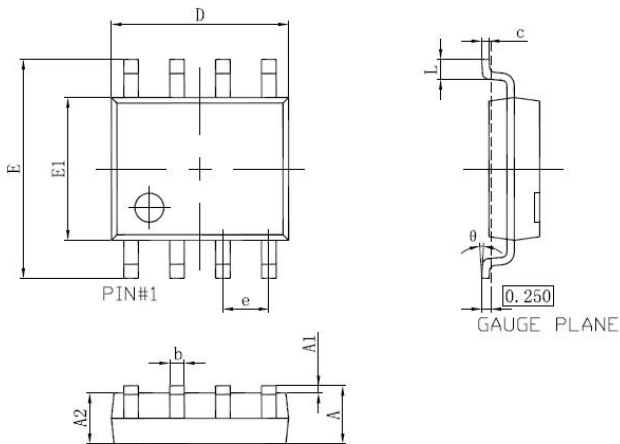

SYMBOL	Millimeters		Inches	
	MIN.	MAX.	MIN.	MAX.
A	1.350	1.750	0.053	0.069
A1	0.100	0.250	0.004	0.010
A2	1.350	1.550	0.053	0.061
b	0.330	0.510	0.013	0.020
c	0.170	0.250	0.007	0.010
D	4.800	5.000	0.189	0.197
e	1.270(BSC)		0.050(BSC)	
E	5.800	6.200	0.228	0.244
E1	3.800	4.000	0.150	0.157
L	0.400	1.270	0.016	0.031
θ	0°	8°	0°	8°

Carrier Tape Specification SO-8

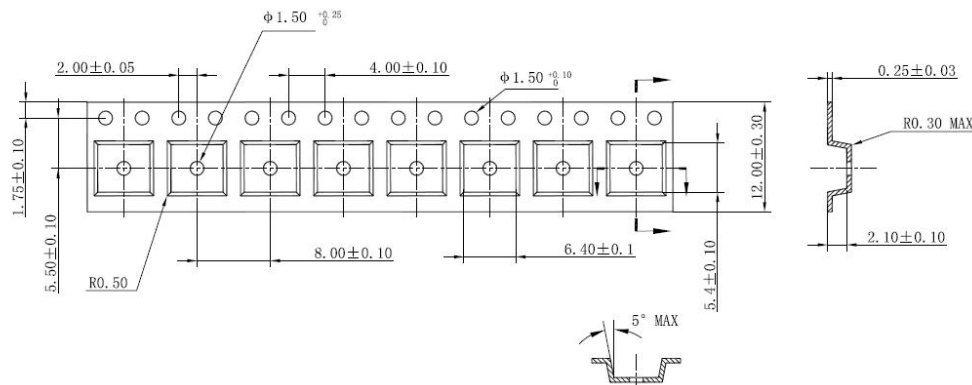

DISCLAIMER:

1- The information given herein, including the specifications and dimensions, is subject to change without prior notice to improve product characteristics. Before ordering, purchasers are advised to contact the SMC - Sangdest Microelectronics (Nanjing) Co., Ltd sales department for the latest version of the datasheet(s).

2- In cases where extremely high reliability is required (such as use in nuclear power control, aerospace and aviation, traffic equipment, medical equipment, and safety equipment), safety should be ensured by using semiconductor devices that feature assured safety or by means of users' fail-safe precautions or other arrangement.

3- In no event shall SMC - Sangdest Microelectronics (Nanjing) Co., Ltd be liable for any damages that may result from an accident or any other cause during operation of the user's units according to the datasheet(s). SMC - Sangdest Microelectronics (Nanjing) Co., Ltd assumes no responsibility for any intellectual property claims or any other problems that may result from applications of information, products or circuits described in the datasheets.

4- In no event shall SMC - Sangdest Microelectronics (Nanjing) Co., Ltd be liable for any failure in a semiconductor device or any secondary damage resulting from use at a value exceeding the absolute maximum rating.

5- No license is granted by the datasheet(s) under any patents or other rights of any third party or SMC - Sangdest Microelectronics (Nanjing) Co., Ltd.

6- The datasheet(s) may not be reproduced or duplicated, in any form, in whole or part, without the expressed written permission of SMC - Sangdest Microelectronics (Nanjing) Co., Ltd.

7- The products (technologies) described in the datasheet(s) are not to be provided to any party whose purpose in their application will hinder maintenance of international peace and safety nor are they to be applied to that purpose by their direct purchasers or any third party. When exporting these products (technologies), the necessary procedures are to be taken in accordance with related laws and regulations..