

SP8008 Series Diode Array

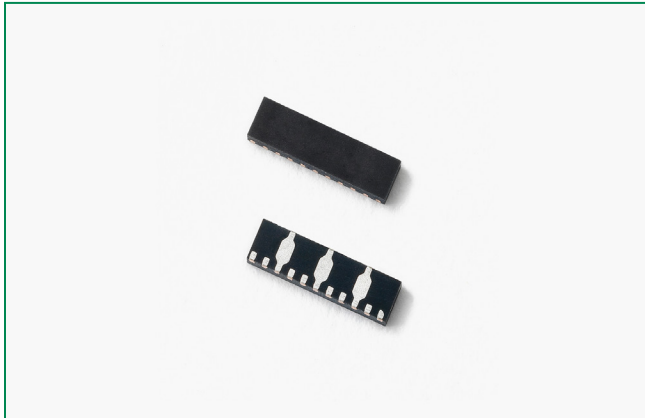

Description

The SP8008 integrates eight channels of ultra low capacitance common mode protection for electronic equipment exposed to electrostatic discharges (ESD). This robust component can effectively protect against ESD events exceeding the IEC 61000-4-2 contact ESD level of ± 8 kV without any performance degradation. The extremely low loading capacitance also makes it ideal for protecting high speed signal pins such as V-by-One, Embedded DisplayPort, HDMI 1.0 through 2.1 and USB 2.0/3.0/3.1.

Pinout

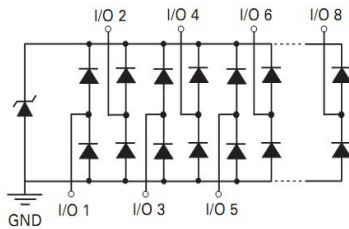

Features

- ESD, IEC 61000-4-2, +30kV/-23kV contact, +30kV/-23kV air
- EFT, IEC 61000-4-4, 40A ($t_p=5/50$ ns)
- Lightning, IEC 61000-4-5 2nd edition, 4A ($t_p=8/20$ μ s)
- Low capacitance of 0.3pF @0V, 3GHz (TYP) per I/O
- Low leakage current of 0.5 μ A (MAX) at 5V
- Small form factor μ DFN packages (JEDEC MO-229) saves board space and supports straight-through routing of the data lines.
- Halogen free, Lead free and RoHS compliant

Functional Block Diagram

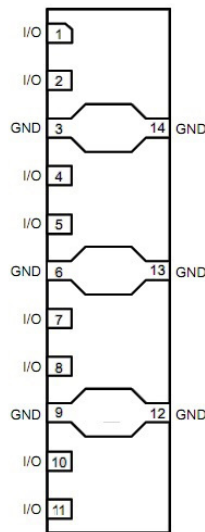

Applications

- LCD/PDP TVs
- LCD/LED Monitors
- Notebook Computers
- Ultrabooks
- Automotive Displays
- Flat Panel Displays
- Digital Signage
- HD Cameras/Projectors
- USB and HDMI interfaces

Life Support Note:

Not Intended for Use in Life Support or Life Saving Applications

The products shown herein are not designed for use in life sustaining or life saving applications unless otherwise expressly indicated.

Absolute Maximum Ratings

Symbol	Parameter	Value	Units
I_{PP}	Peak Current ($t_p=8/20\mu s$)	4.0	A
T_{OP}	Operating Temperature	-40 to 125	°C
T_{STOR}	Storage Temperature	-55 to 150	°C

CAUTION: Stresses above those listed in "Absolute Maximum Ratings" may cause permanent damage to the device. This is a stress only rating and operation of the device at these or any other conditions above those indicated in the operational sections of this specification is not implied.

Electrical Characteristics ($T_{OP}=25^\circ C$)

Parameter	Symbol	Test Conditions	Min	Typ	Max	Units
Reverse Standoff Voltage	V_{RWM}				5	V
Reverse Breakdown Voltage	V_{BR}	$I_R=1mA$	6			V
Reverse Leakage Current	I_{LEAK}	$V_R=5V$, I/O to GND			0.5	μA
Clamp Voltage ¹	V_C	$I_{PP}=1A$, $t_p=8/20\mu A$, Fwd		9.39		V
		$I_{PP}=2A$, $t_p=8/20\mu A$, Fwd		10.38		V
		$I_{PP}=4A$, $t_p=8/20\mu A$, Fwd		12.45		V
Dynamic Resistance ¹	R_{DYN}	TLP, $t_p=100ns$, I/O to GND		0.4		Ω
ESD Withstand Voltage ¹	V_{ESD}	IEC 61000-4-2 (Contact)			+30 / -23	kV
		IEC 61000-4-2 (Air)			+30 / -23	kV
Diode Capacitance ¹	$C_{I/O-GND}$	Reverse Bias=0V, $f=3 GHz$		0.3		pF

Note: ¹ Parameter is guaranteed by design and/or component characterization.

8/20 μS Pulse Waveform

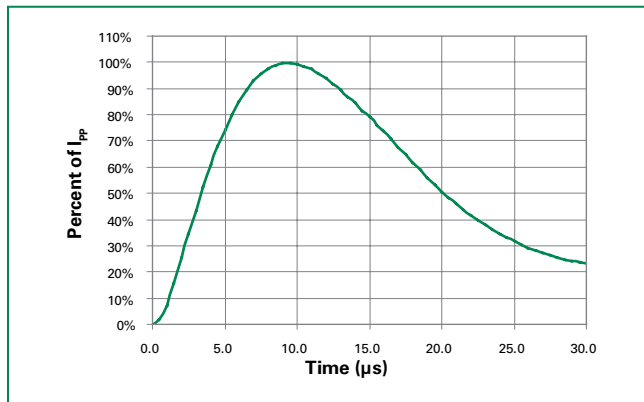

Clamping Voltage vs. I_{PP}

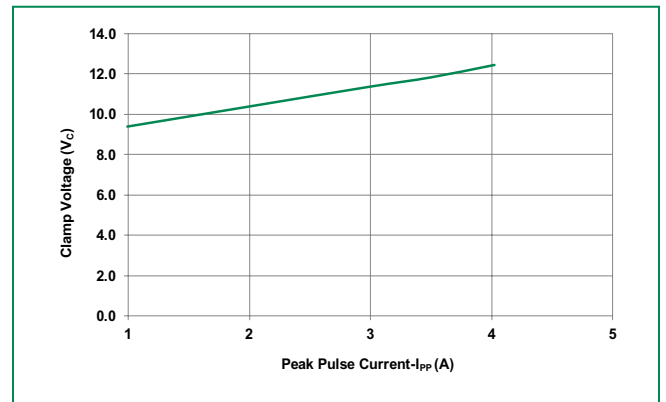

Positive Transmission Line Pulsing (TLP) Plot

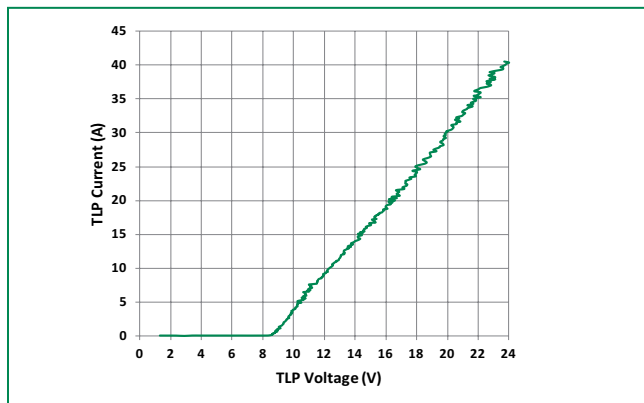

Negative Transmission Line Pulsing (TLP) Plot

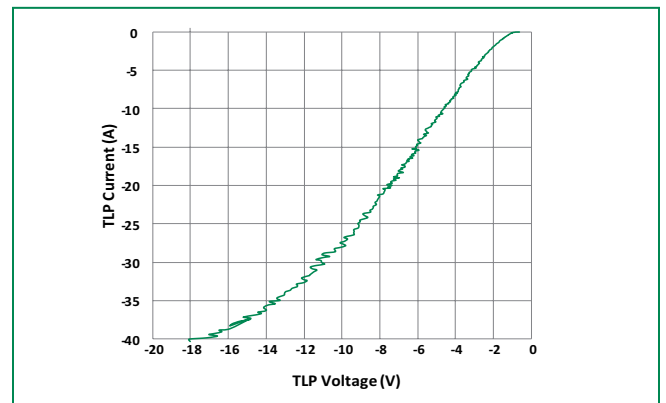

IEC 61000-4-2 +8 kV Contact ESD Clamping Voltage

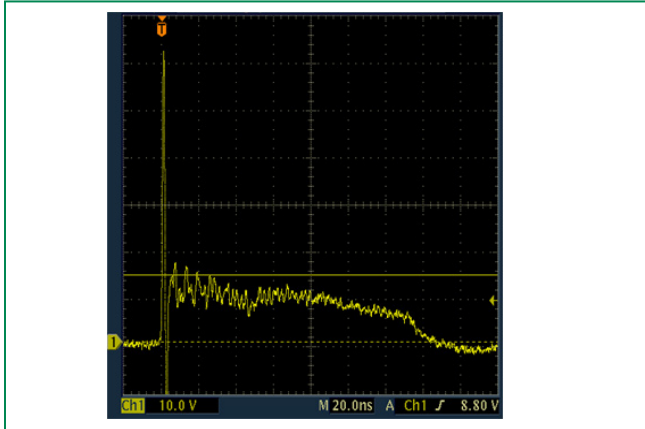

IEC 61000-4-2 -8 kV Contact ESD Clamping Voltage

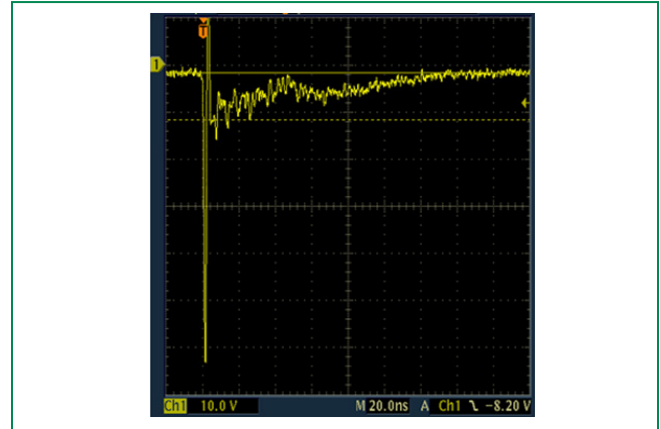

Eye diagram 5Gbps, 2.5 GHz w/SP8008-08UTG

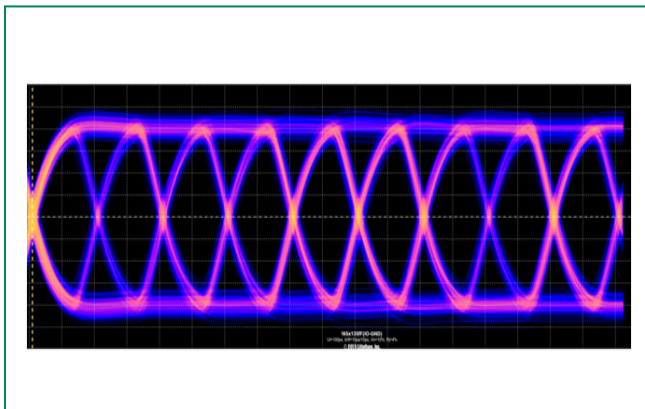

Insertion Loss Diagram

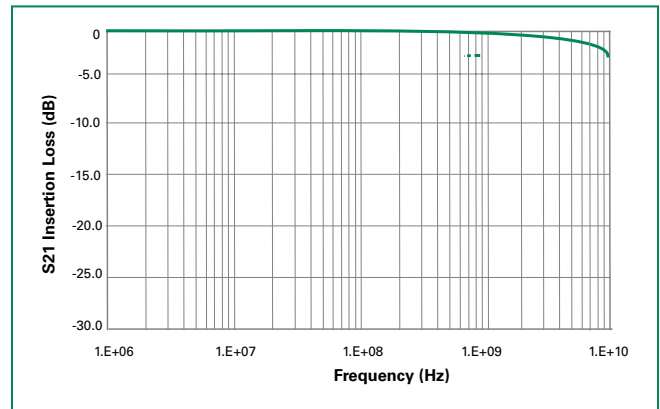

Soldering Parameters

Reflow Condition		Pb – Free assembly
Pre Heat	- Temperature Min ($T_{s(min)}$)	150°C
	- Temperature Max ($T_{s(max)}$)	200°C
	- Time (min to max) (t_s)	60 – 180 secs
Average ramp up rate (Liquidus) Temp (T_L) to peak		3°C/second max
$T_{s(max)}$ to T_L - Ramp-up Rate		3°C/second max
Reflow	- Temperature (T_L) (Liquidus)	217°C
	- Temperature (t_L)	60 – 150 seconds
Peak Temperature (T_p)		260 ^{+0/-5} °C
Time within 5°C of actual peak Temperature (t_p)		20 – 40 seconds
Ramp-down Rate		6°C/second max
Time 25°C to peak Temperature (T_p)		8 minutes Max.
Do not exceed		260°C

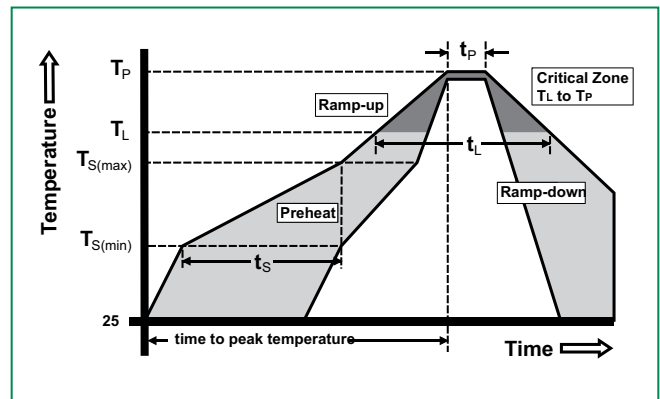

Part Numbering System

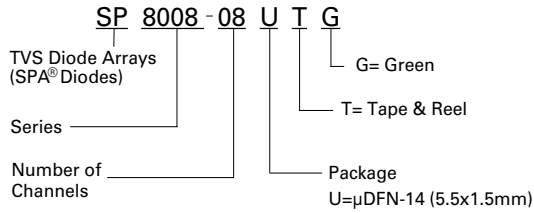

Part Marking System

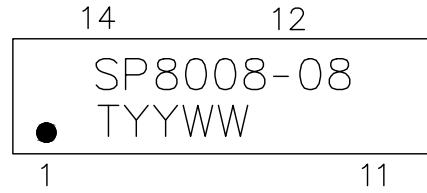

SP8008-08 = Part Number
T = Assembly Code
YY = Yearly code
WW = Weekly code

Ordering Information

Part Number	Package	Marking	Min. Order Qty.
SP8008-08UTG	µDFN-14	SP8008-08	3000

Package Dimensions

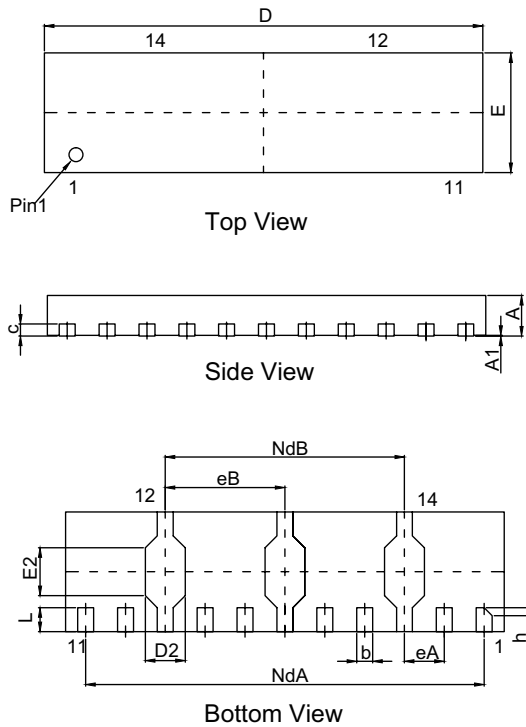

µDFN-14(5.5x1.5x0.5mm)						
JEDEC MO-229						
Symbol	Millimeters			Inches		
	Min	Nom	Max	Min	Nom	Max
A	0.45	0.50	0.55	0.018	0.020	0.022
A1	0.00	0.02	0.05	0.000	0.001	0.002
b	0.15	0.20	0.25	0.006	0.008	0.010
c	0.10	0.15	0.20	0.004	0.006	0.008
D	5.45	5.50	5.55	0.215	0.217	0.219
D2	0.45	0.50	0.55	0.018	0.020	0.022
NdA	5.00 BSC			0.197 BSC		
eA	0.50 BSC			0.020 BSC		
eB	1.50 BSC			0.059 BSC		
NdB	3.00 BSC			0.118 BSC		
E	1.45	1.50	1.55	0.057	0.059	0.061
E2	0.55	0.60	0.65	0.022	0.024	0.026
L	0.20	0.30	0.40	0.008	0.012	0.016
h	0.05	0.10	0.15	0.002	0.004	0.006

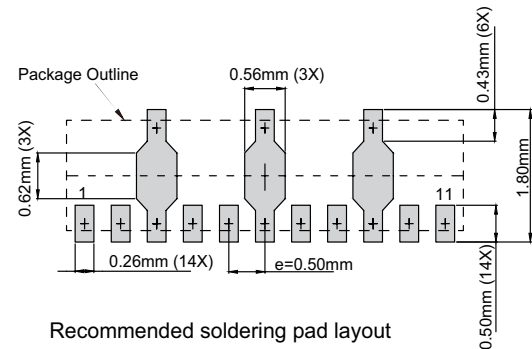

Embossed Carrier Tape & Reel Specification – μ DFN-14

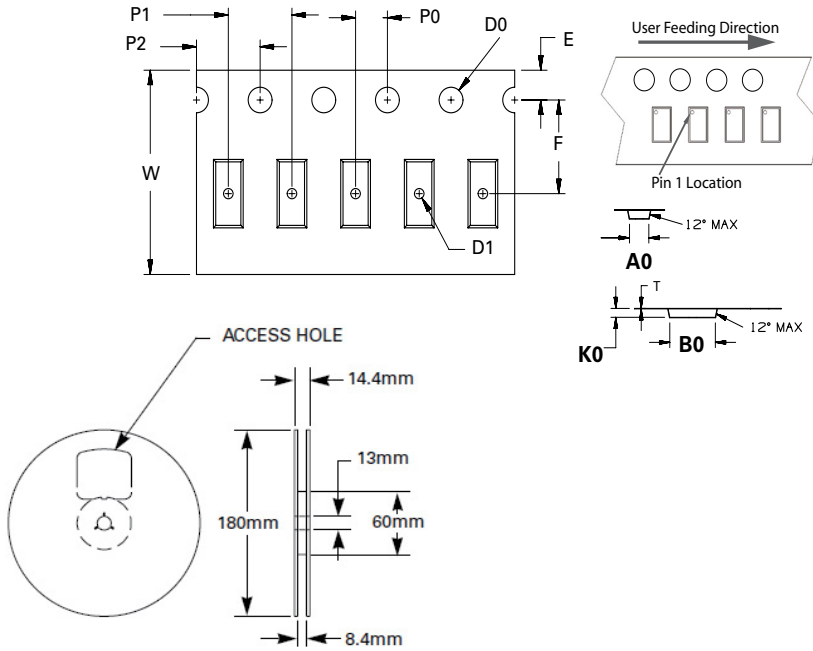

Symbol	Millimeters
A0	1.75 +/- 0.10
B0	5.75 +/- 0.10
D0	1.50 + 0.10 /-0
D1	Ø 1.0 min
E	1.75 +/- 0.10
F	5.50 +/- 0.05
K0	0.70 +/- 0.10
P0	2.00 +/- 0.05
P1	4.00 +/- 0.10
P2	4.00 +/- 0.10
T	0.30 +/- 0.05
W	12.00 + 0.30 /- 0.10