



SMT GaAs pHEMT DUAL CHANNEL LOW NOISE AMPLIFIER, 230 - 660 MHz

Typical Applications

The HMC816LP4E is ideal for:

- Cellular/3G and LTE/WiMAX/4G
- BTS & Infrastructure
- Repeaters and Femtocells
- Public Safety Radio
- Multi-Channel Applications

Features

- Low Noise Figure: 0.5 dB
- High Gain: 22 dB
- High Output IP3: +37 dBm
- Single Supply: +3V to +5V
- 50 Ohm Matched Input/Output
- 24 Lead 4x4mm QFN Package: 16 mm²

Functional Diagram

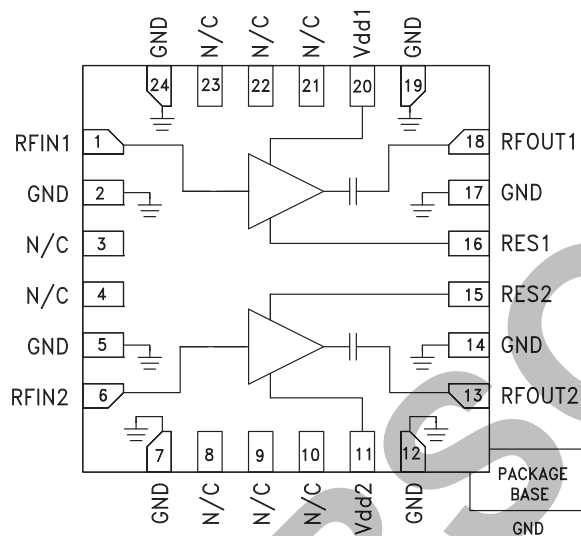

General Description

The HMC816LP4E is a GaAs pHEMT Dual Channel Low Noise Amplifier that is ideal for Cellular/3G and LTE/WiMAX/4G basestation front-end receivers operating between 230 and 660 MHz. The amplifier has been optimized to provide 0.5 dB noise figure, 22 dB gain and +37 dBm output IP3 from a single supply of +5V. Input and output return losses are excellent with minimal external matching and bias decoupling components. The HMC816LP4E shares the same package and pinout with the HMC817-LP4E & HMC818LP4E LNAs. The HMC817LP4E can be biased with +3V to +5V and features an externally adjustable supply current which allows the designer to tailor the linearity performance of each channel of the LNA for each application.

Electrical Specifications, $T_A = +25^\circ C$, Rbias 1, 2 = 10k Ohms*, Vdd = Vdd1, Vdd2 = +5V, Idd = Idd1, Idd2

Parameter	Vdd = +3V						Vdd = +5V						Units
	Min.	Typ.	Max.	Min.	Typ.	Max.	Min.	Typ.	Max.	Min.	Typ.	Max.	
Frequency Range	230 - 450			450 - 660			230 - 450			450 - 660			MHz
Gain	17	21		14	17		19	22		15	19		dB
Gain Variation Over Temperature		0.001			0.002			0.005			0.007		dB/°C
Noise Figure		0.5	0.9		0.5	0.9		0.5	0.9		0.5	0.9	dB
Input Return Loss		13			17			15			16		dB
Output Return Loss		12			10			13			10		dB
Output Power for 1 dB Compression (P1dB)	10	14		13	16		15	19		18	21		dBm
Saturated Output Power (Psat)	10	15		14	16.5		16	20		18	21		dBm
Output Third Order Intercept (IP3)		26			28			34			37		dBm
Supply Current (Idd)	24	34	44	24	34	44	68	97	126	68	97	126	mA

* Rbias sets current, see application circuit herein



SMT GaAs pHEMT DUAL CHANNEL LOW NOISE AMPLIFIER, 230 - 660 MHz

Broadband Gain & Return Loss

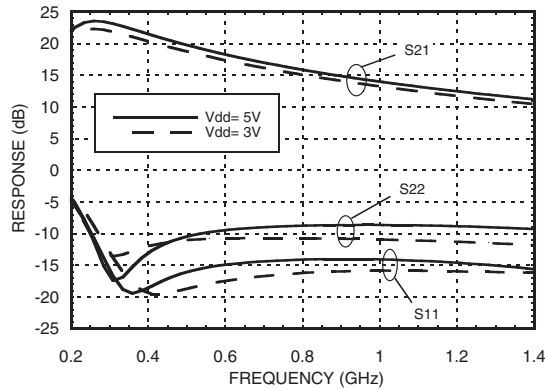

Gain vs. Temperature [1]

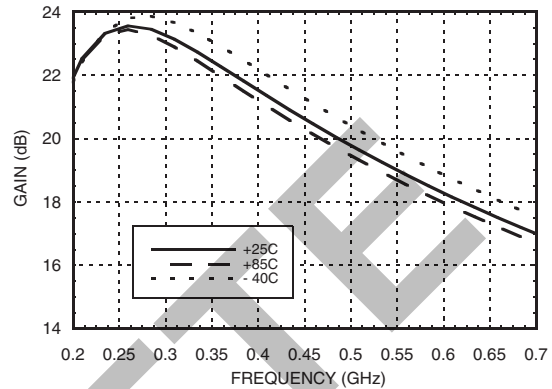

Gain vs. Temperature [2]

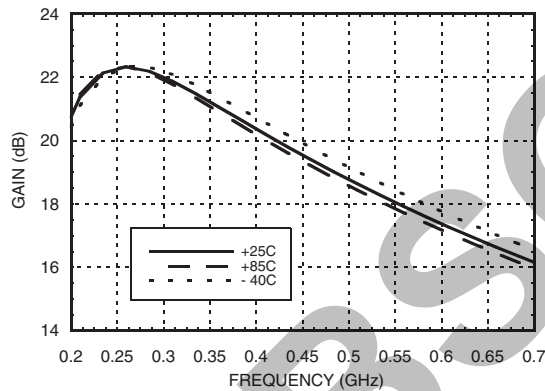

Input Return Loss vs. Temperature [1]

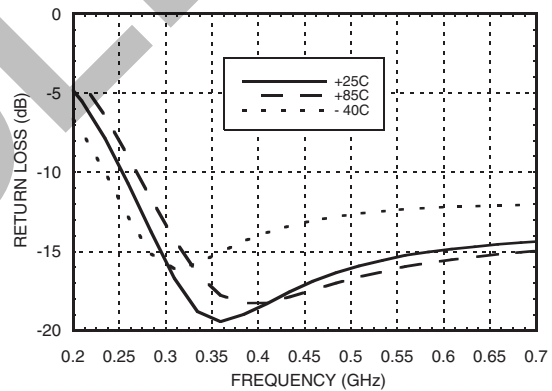

Output Return Loss vs. Temperature [1]

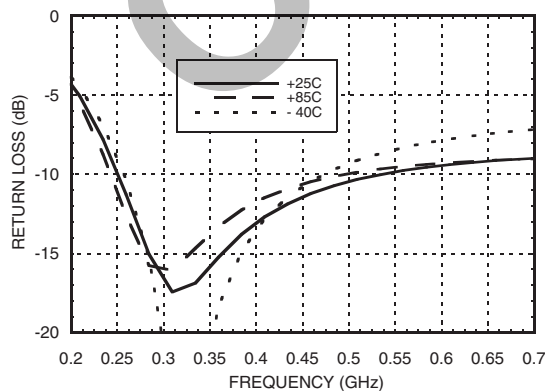

Reverse Isolation vs. Temperature [1]

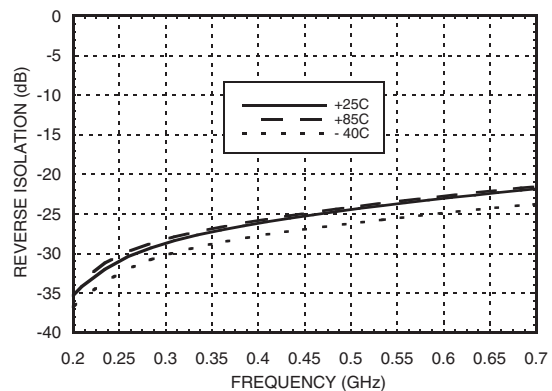

[1] Vdd = 5V [2] Vdd = 3V

Information furnished by Analog Devices is believed to be accurate and reliable. However, no responsibility is assumed by Analog Devices for its use, nor for any infringements of patents or other rights of third parties that may result from its use. Specifications subject to change without notice. No license is granted by implication or otherwise under any patent or patent rights of Analog Devices. Trademarks and registered trademarks are the property of their respective owners.

For price, delivery, and to place orders: Analog Devices, Inc., One Technology Way, P.O. Box 9106, Norwood, MA 02062-9106 Phone: 781-329-4700 • Order online at www.analog.com Application Support: Phone: 1-800-ANALOG-D



SMT GaAs pHEMT DUAL CHANNEL LOW NOISE AMPLIFIER, 230 - 660 MHz

7

AMPLIFIERS - LOW NOISE - SMT

Noise Figure vs. Temperature [1]

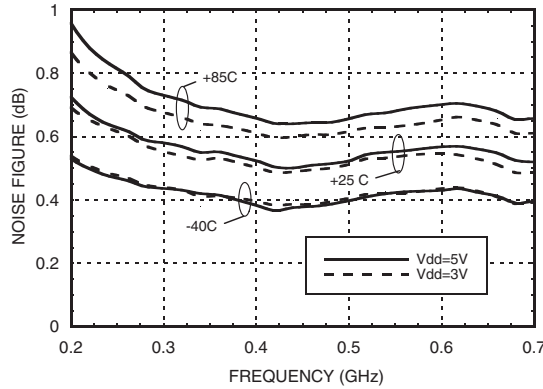

P1dB vs. Temperature

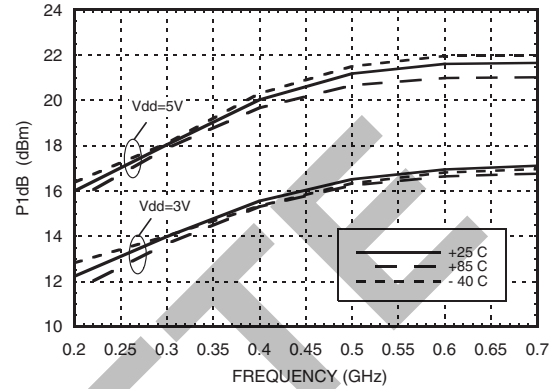

Psat vs. Temperature

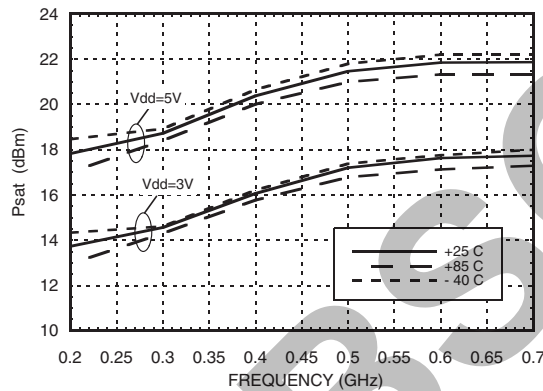

Output IP3 vs. Temperature

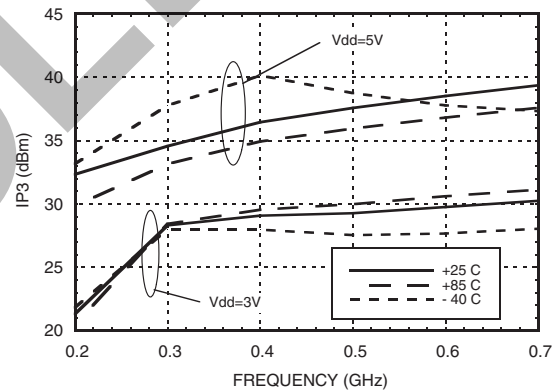

Output IP3 and Supply Current vs. Supply Voltage @ 400 MHz

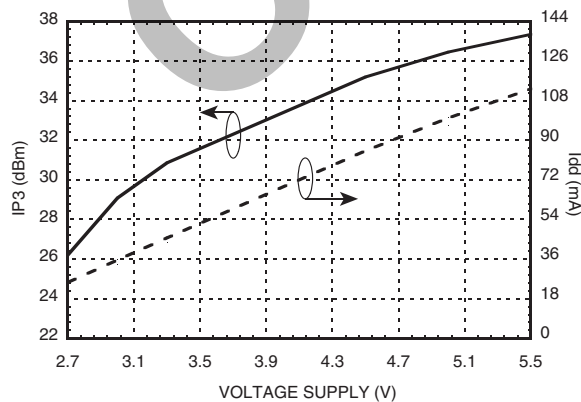

Output IP3 and Supply Current vs. Supply Voltage @ 500 MHz

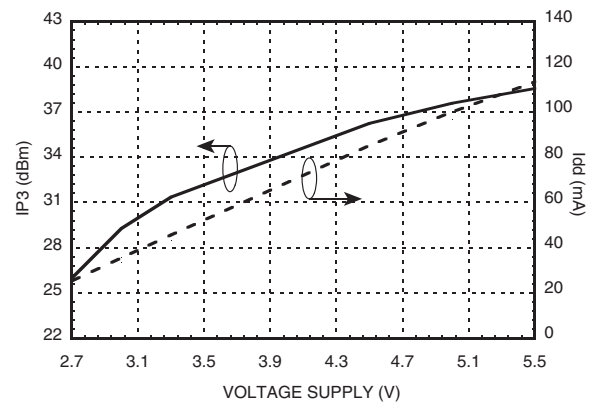

[1] Measurement reference plane shown on evaluation PCB drawing.



SMT GaAs pHEMT DUAL CHANNEL LOW NOISE AMPLIFIER, 230 - 660 MHz

Power Compression @ 400 MHz [1]

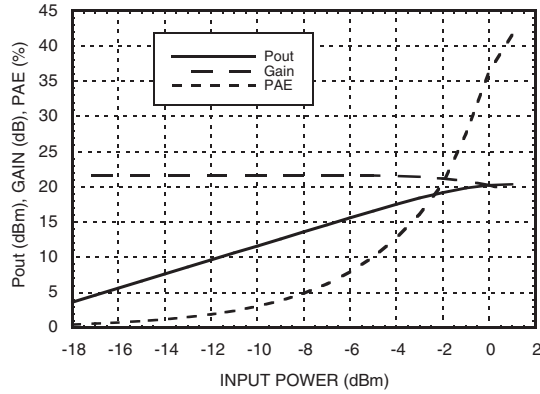

Power Compression @ 400 MHz [2]

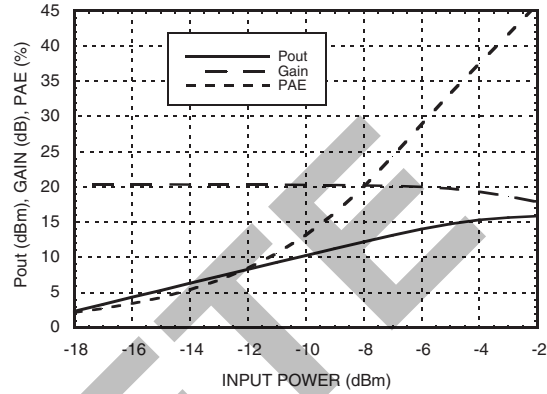

Power Compression @ 500 MHz [1]

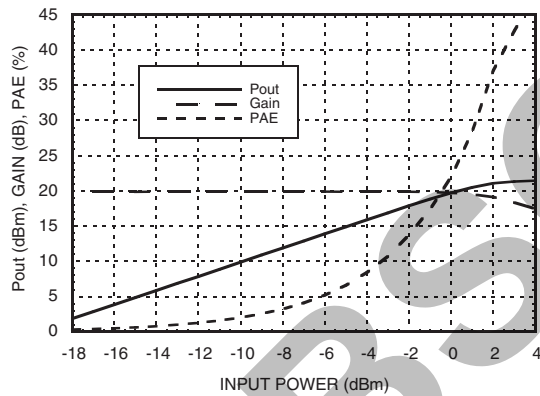

Power Compression @ 500 MHz [2]

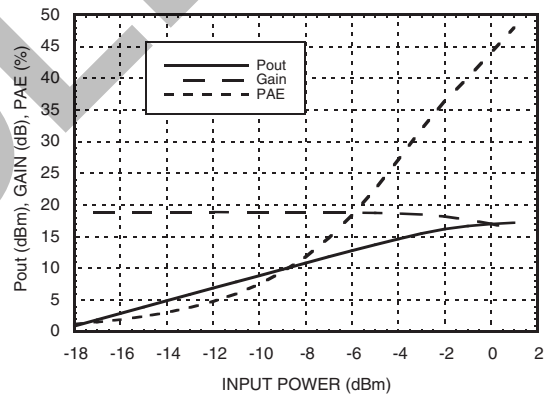

Gain, Power & Noise Figure vs. Supply Voltage @ 400 MHz

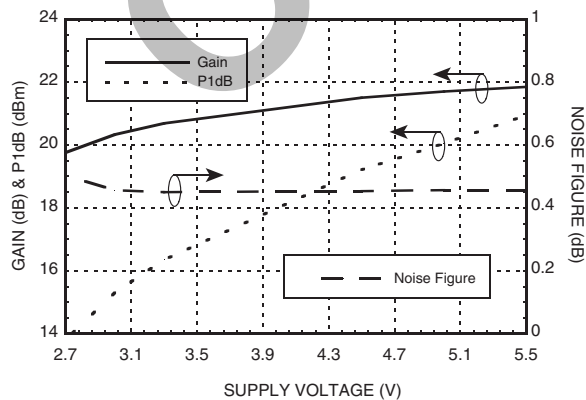

Gain, Power & Noise Figure vs. Supply Voltage @ 500 MHz

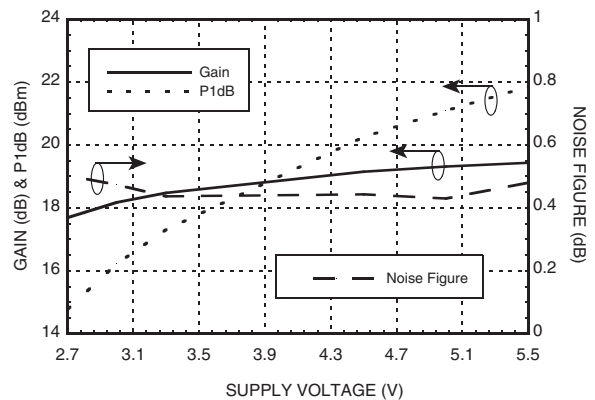

[1] Vdd = 5V [2] Vdd = 3V

Information furnished by Analog Devices is believed to be accurate and reliable. However, no responsibility is assumed by Analog Devices for its use, nor for any infringements of patents or other rights of third parties that may result from its use. Specifications subject to change without notice. No license is granted by implication or otherwise under any patent or patent rights of Analog Devices. Trademarks and registered trademarks are the property of their respective owners.

For price, delivery, and to place orders: Analog Devices, Inc., One Technology Way, P.O. Box 9106, Norwood, MA 02062-9106 Phone: 781-329-4700 • Order online at www.analog.com Application Support: Phone: 1-800-ANALOG-D



SMT GaAs pHEMT DUAL CHANNEL LOW NOISE AMPLIFIER, 230 - 660 MHz

Output IP3 vs. Rbias @ 400 MHz

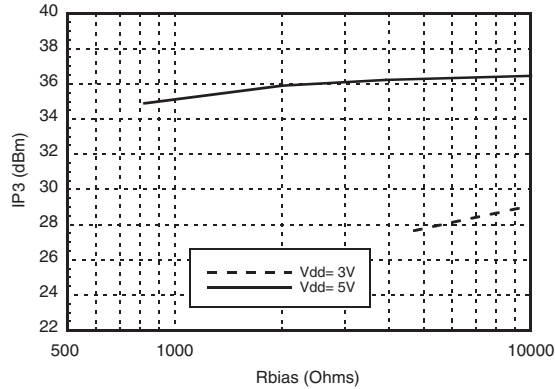

Output IP3 vs. Rbias @ 500 MHz

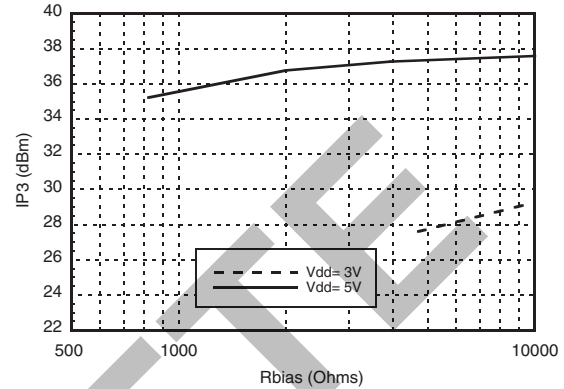

Cross Channel Isolation [1]

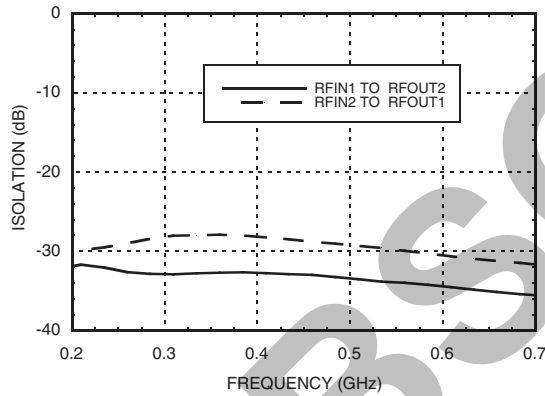

Magnitude Balance [1]

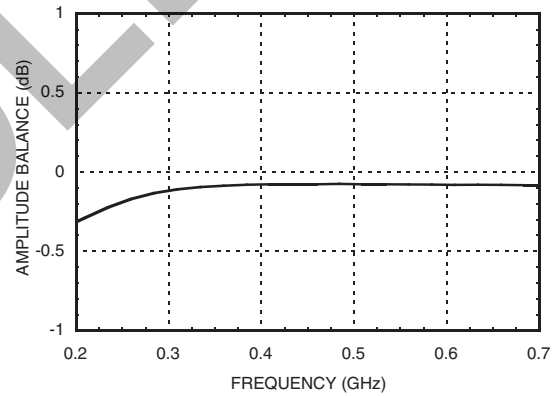

Phase Balance [1]

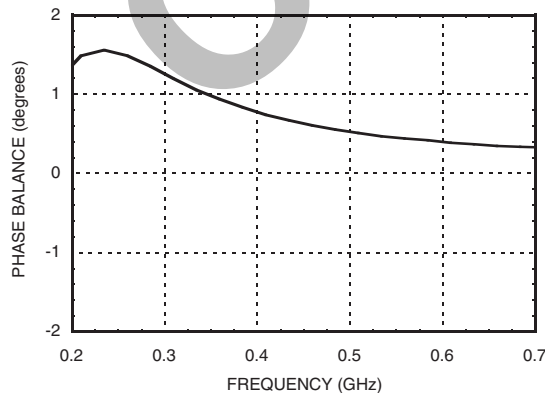

Absolute Bias Register for Idd Range & Recommended Bias Resistor

Vdd (V)	Rbias Ω			Idd (mA)
	Min	Max	Recommended	
3V	4.7k	Open circuit	10k	34
			820	65
5V	0	Open circuit	2k	80
			3.92k	90
			10k	97

With Vdd = 3V Rbias < 4.7k is not recommended and may result in LNA becoming conditionally unstable.

[1] Vdd = 5V



SMT GaAs pHEMT DUAL CHANNEL LOW NOISE AMPLIFIER, 230 - 660 MHz

Absolute Maximum Ratings

Drain Bias Voltage (Vdd1, Vdd2)	+6 V
RF Input Power (RFIN1, RFIN2) (Vdd = +5 Vdc)	+10 dBm
Channel Temperature	150 °C
Continuous Pdiss (T= 85 °C) (derate 17.86 mW/°C above 85 °C)	1.16 W
Thermal Resistance (channel to ground paddle)	56 °C/W
Storage Temperature	-65 to +150 °C
Operating Temperature	-40 to +85 °C

Typical Supply Current vs. Vdd (Rbias = 10kΩ)

Vdd1, Vdd2 (V)	Idd1, Idd2 (mA)
2.7	24
3.0	34
3.3	44
4.5	82
5.0	97
5.5	110

Note: Amplifier will operate over full voltage range shown above.



**ELECTROSTATIC SENSITIVE DEVICE
OBSERVE HANDLING PRECAUTIONS**

Outline Drawing

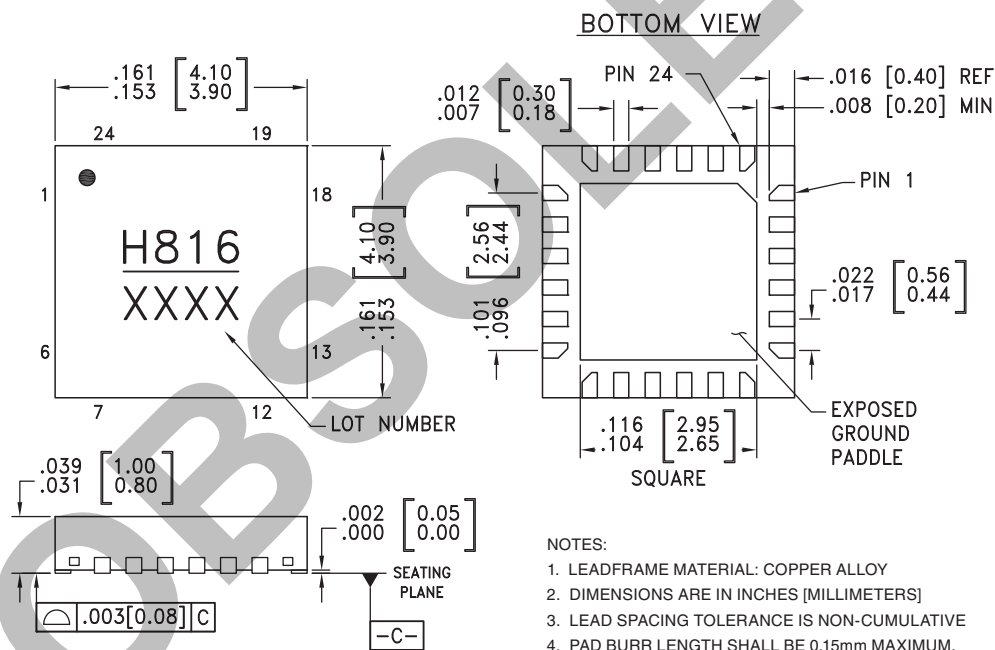

Package Information

Part Number	Package Body Material	Lead Finish	MSL Rating	Package Marking ^[1]
HMC816LP4E	RoHS-compliant Low Stress Injection Molded Plastic	100% matte Sn	MSL1 ^[2]	H816 XXXX

[1] 4-Digit lot number XXXX

[2] Max peak reflow temperature of 260 °C



**SMT GaAs pHEMT DUAL CHANNEL
LOW NOISE AMPLIFIER, 230 - 660 MHz**

Pin Descriptions

Pin Number	Function	Description	Interface Schematic
1, 6	RFIN1, RFIN2	This pins are DC coupled. An off-chip DC blocking capacitor is required.	RFIN1, RFIN2
2, 5, 7, 12, 14, 17, 19, 24	GND	These pins and package bottom must be connected to RF/DC ground.	GND
3, 4, 8 - 10, 21 - 23	N/C	No connection required. These pins may be connected to RF/DC ground without affecting performance.	
18, 13	RFOUT1, RFOUT2	These pins are matched to 50 Ohms.	RFOUT1, RFOUT2
15, 16	RES1, RES2	These pins are used to set the DC current of each amplifier via external bias resistor. See application circuit.	RES1, RES2
20, 11	Vdd1, Vdd2	Power Supply Voltages for each amplifier. Choke inductor and bypass capacitors are required. See application circuit.	Vdd1, Vdd2

Application Circuit

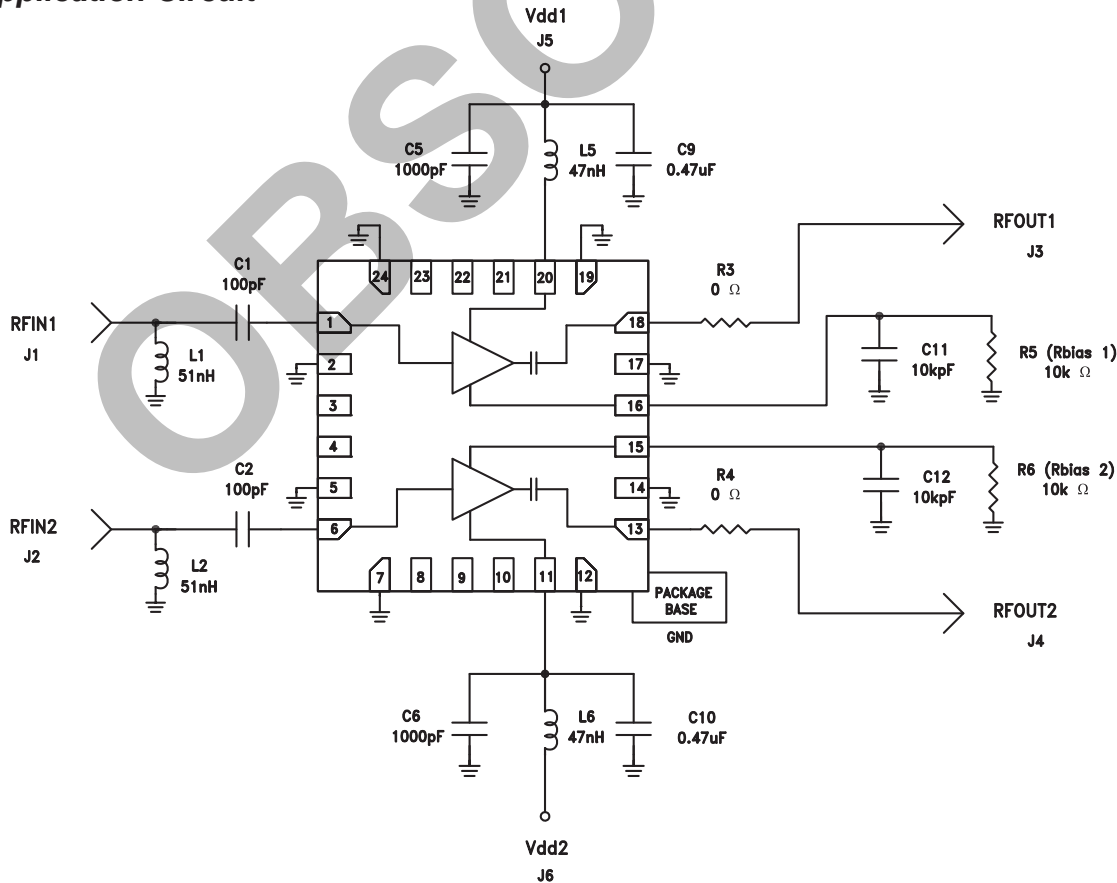

Information furnished by Analog Devices is believed to be accurate and reliable. However, no responsibility is assumed by Analog Devices for its use, nor for any infringements of patents or other rights of third parties that may result from its use. Specifications subject to change without notice. No license is granted by implication or otherwise under any patent or patent rights of Analog Devices. Trademarks and registered trademarks are the property of their respective owners.

For price, delivery, and to place orders: Analog Devices, Inc., One Technology Way, P.O. Box 9106, Norwood, MA 02062-9106 Phone: 781-329-4700 • Order online at www.analog.com Application Support: Phone: 1-800-ANALOG-D

SMT GaAs pHEMT DUAL CHANNEL LOW NOISE AMPLIFIER, 230 - 660 MHz



Evaluation PCB

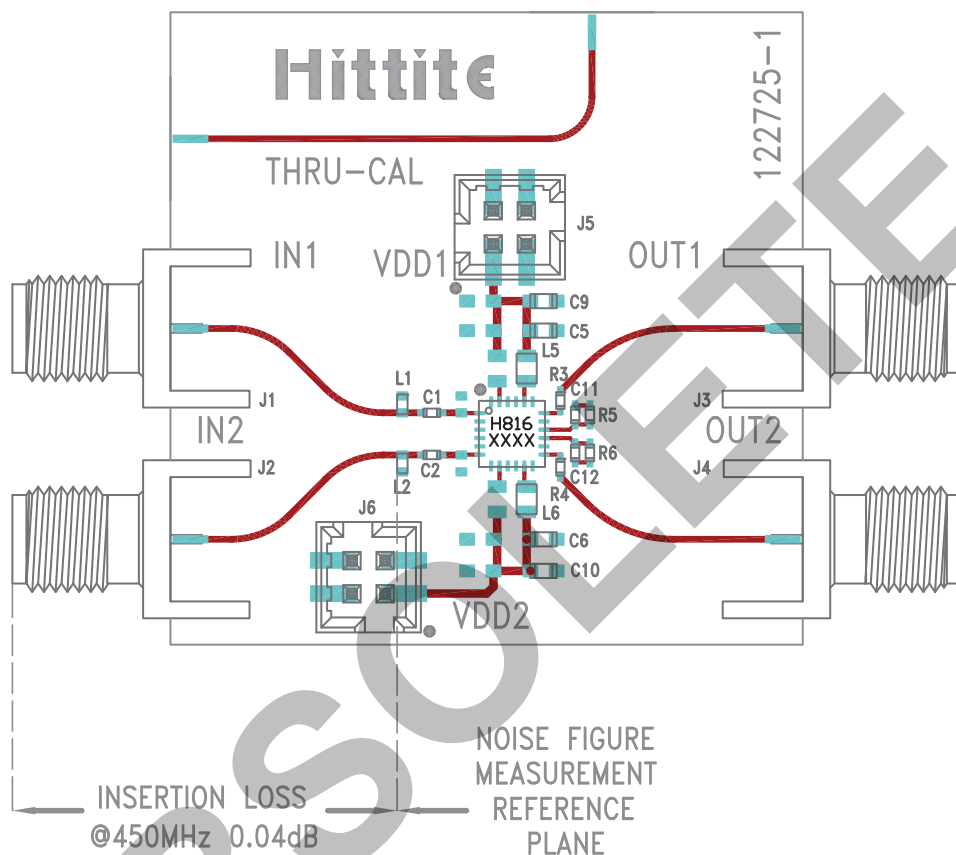

List of Materials for Evaluation PCB 123191 [1]

Item	Description
J1 - J4	PCB Mount SMA RF Connector
J5, J6	2mm Vertical Molex 8pos Connector
C1, C2	100 pF Capacitor, 0402 Pkg.
C5, C6	1000 pF Capacitor, 0603 Pkg.
C9, C10	0.47 μF Capacitor, 0402 Pkg.
C11, C12	10k pF Capacitor, 0402 Pkg.
R3, R4	0 Ohm Resistor, 0402 Pkg.
R5, R6 (Rbias1,2)	10k Ohm Resistor, 0402 Pkg.
L1, L2	51 nH Inductor, 0402 Pkg.
L3, L4	47 nH Inductor, 0603 Pkg.
U1	HMC816LP4E Amplifier
PCB [2]	122725 Evaluation PCB

[1] Reference this number when ordering complete evaluation PCB

[2] Circuit Board Material: Rogers 4350 or Arlon 25FR

The circuit board used in this application should use RF circuit design techniques. Signal lines should have 50 Ohm impedance while the package ground leads and exposed paddle should be connected directly to the ground plane similar to that shown. A sufficient number of via holes should be used to connect the top and bottom ground planes. The evaluation board should be mounted to an appropriate heat sink. The evaluation circuit board shown is available from Hittite upon request.