



Close-up of connector and pin

TG.22.0111w

## Specification

<b>Part No.</b>	TG.22.0111w
<b>Product Name</b>	TG22 2G/3G Cellular Connector Mount Monopole Antenna GPRS-GSM-DCS-PCS-UMTS-CDMA- EDGE-HSPA 824MHz ~2170 MHz
<b>Feature</b>	Ground dependent (Needs mounting to ground-plane) 3dBi Gain 30%+ Efficiency Dimensions - 49mm * 8mm 50 Ohms Straight SMA Male Connector customizable ROHS Compliant

## 1. Introduction

The TG.22.0111 2G/3G monopole helical antenna operates from 824MHz to 2170MHz on GSM-DCS-PCS-UMTS-CDMA-GPRS-EDGE-HSPA. Once mounted to an adequate ground-plane it is a compact robust terminal antenna with high gain and stable efficiency in a small form factor. Connection is made via straight SMA(M) connector.

Typical applications - Remote monitoring

At only 49mm in height, with a hardened TPEE casing, this antenna is the ideal GPRS/UMTS antenna for telematics devices where larger antennas cannot be used.

Like all small monopole antennas, it must be mounted on a ground-plane to radiate efficiently. The antenna should be mounted at the edge of the ground-plane of the mainboard of the device. See below charts for analysis of performance. A larger ground-plane of more than 100mm is needed for stable performance on all bands. Also no metal should be used near the antenna, with at least 20mm of clearance required, the more clearance the better.

For devices with ground-planes smaller than 100mm in length or where metal clearance is not adequate, alternative larger antennas should be considered such as the TG.30. If small size is needed, a custom tuned solution or a new design may also be necessary. Contact your Taoglas regional sales office for support.

## 2. Key Antenna Performance Indicators

### 2.1 Electrical Specifications

Parameter	Specification				
Bands	GSM850	GSM900	DCS	PCS	WCDMA I
Frequency range	824~896MHz	880~960MHz	1710~1880MHz	1850~1990MHz	1920~2170MHz
Return Loss	≤-5dB				
VSWR	≤3.5dB				
Peak Gain	1.42dBi	1.91dBi	2.51dBi	3.23dBi	2.89dBi
Efficiency	64.40%	68.29%	70.67%	72.61%	68.48%
Average Gain	-1.92dBi	-1.66dBi	-1.51dBi	-1.39dBi	-1.67dBi
Polarization	Linear				
Power handling	20 W				
Impedance	50 Ohms				
Connector	Straight SMA(M)				

\*All the antenna characteristics were measured with 150mm\*90mm ground plane

### 2.2 Environmental & Mechanical Characteristics

Parameter	Specification
Temperature	-40 C to +85 C
Radome color	Black
Radome material	TPEE
Weight	6 g

### 3. Test Set Up

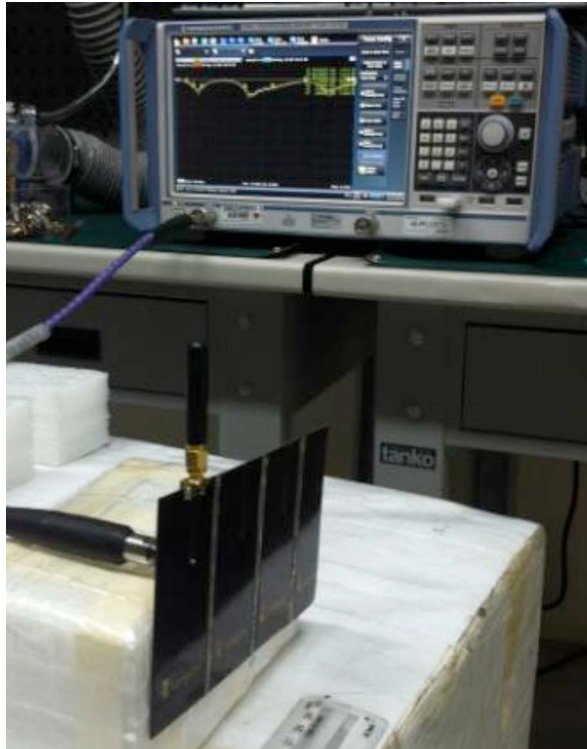

Figure 1. Impedance and VSWR measurements

## 4. Antenna Parameters

### 4.1 Return Loss

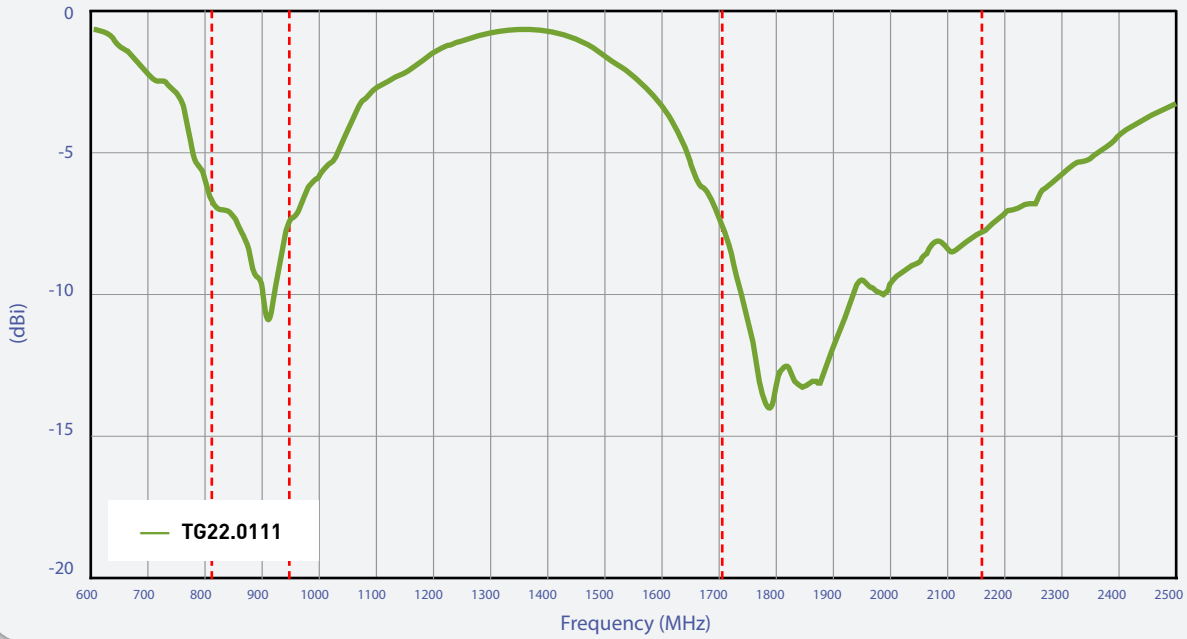

Figure 2. Return Loss of TG.22.0111

### 4.2 VSWR

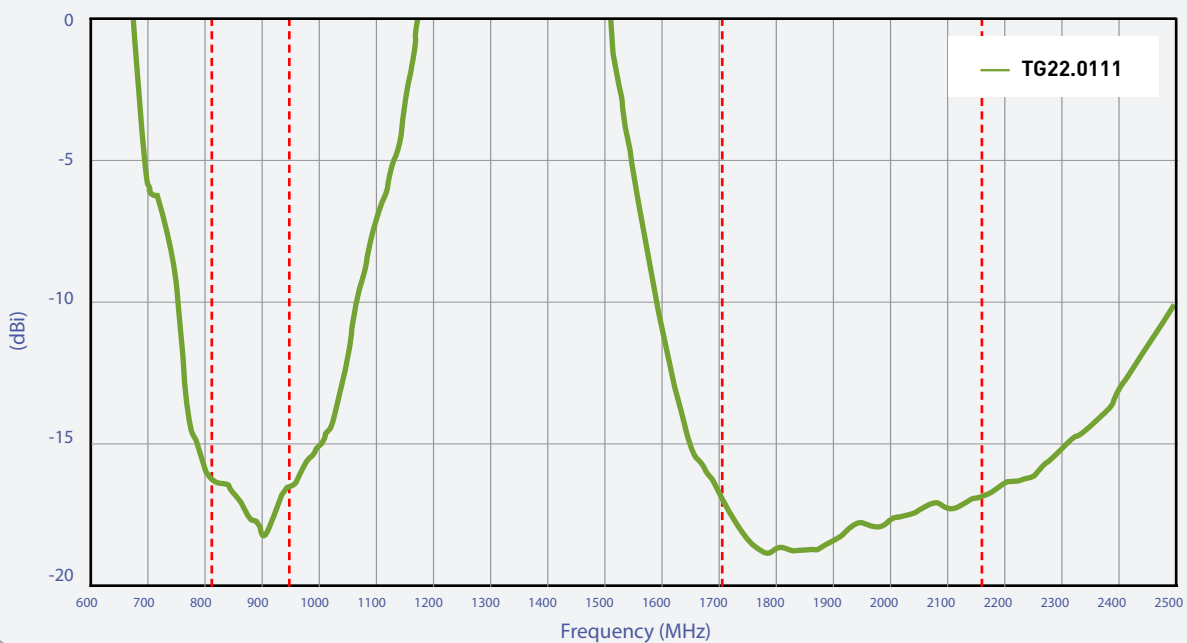

Figure 3. VSWR of TG.22.0111

### 4.3 Efficiency (%)

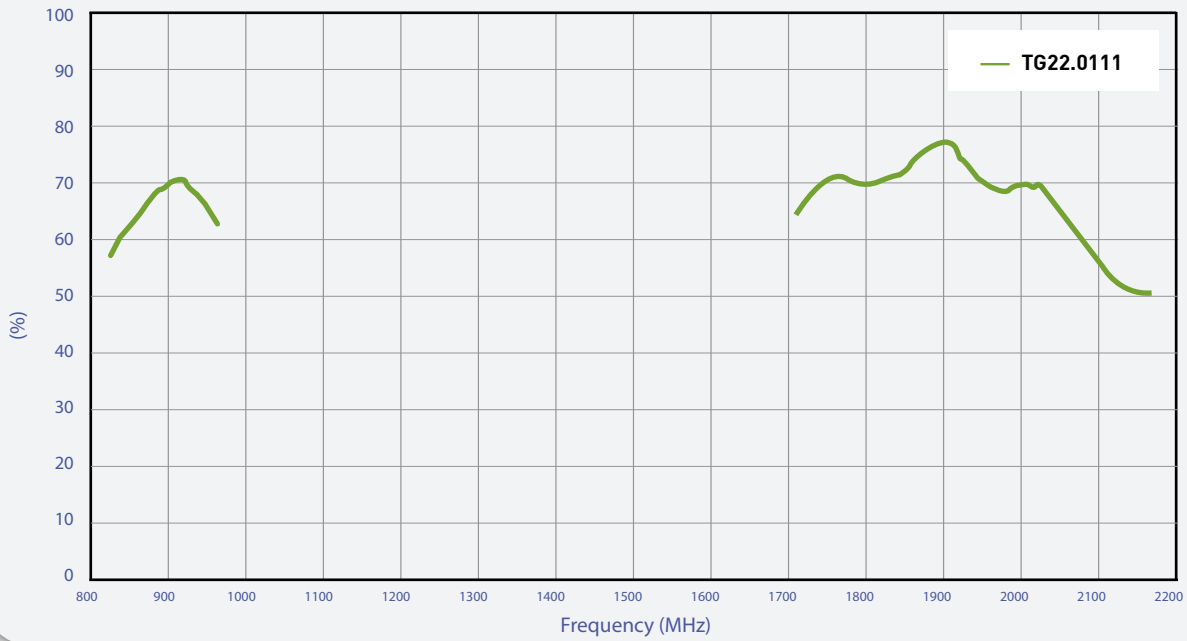

Figure 4. Efficiency of TG.22.0111

### 4.4 Peak Gain (dBi)

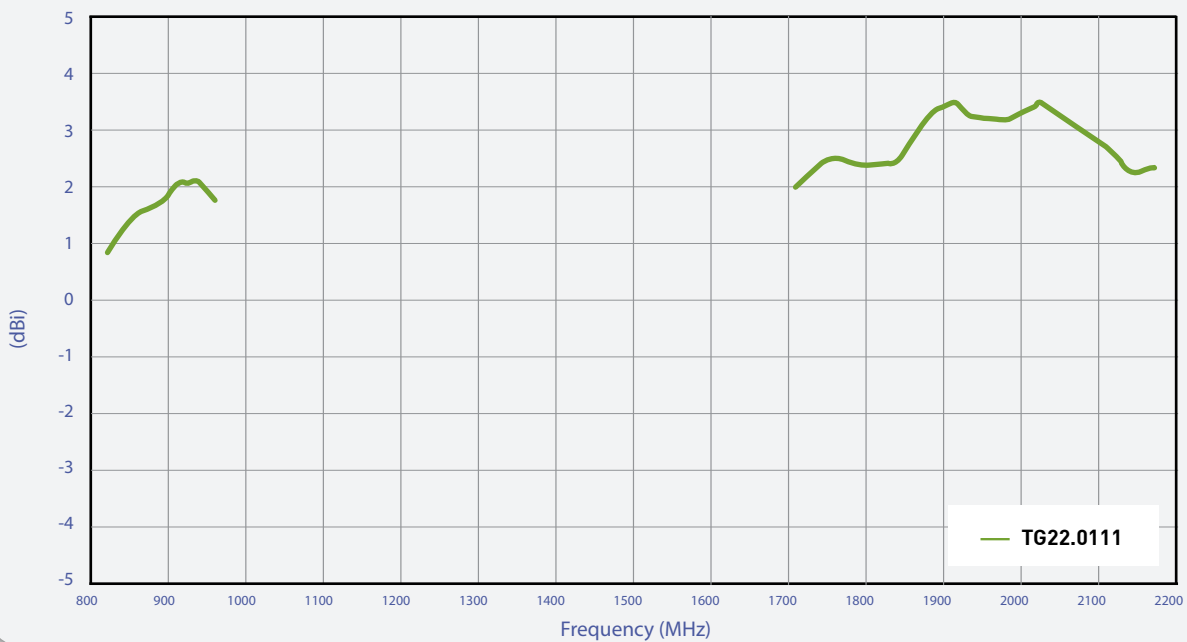

Figure 5. Peak Gain of TG.22.0111

#### 4.5 Average Gain(dBi)

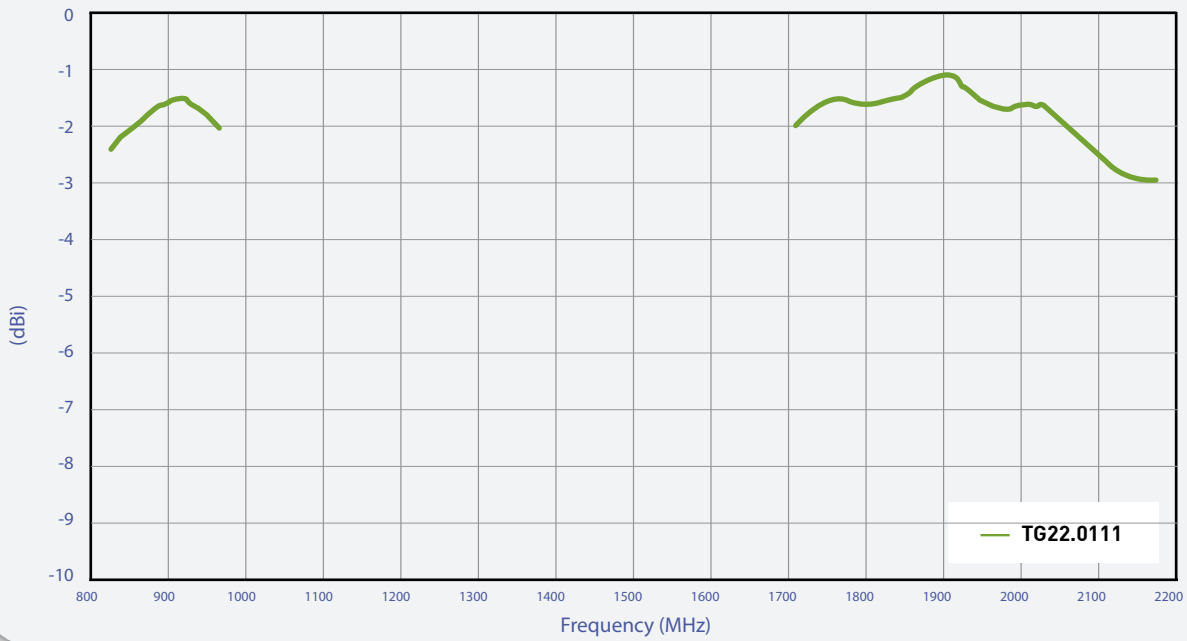
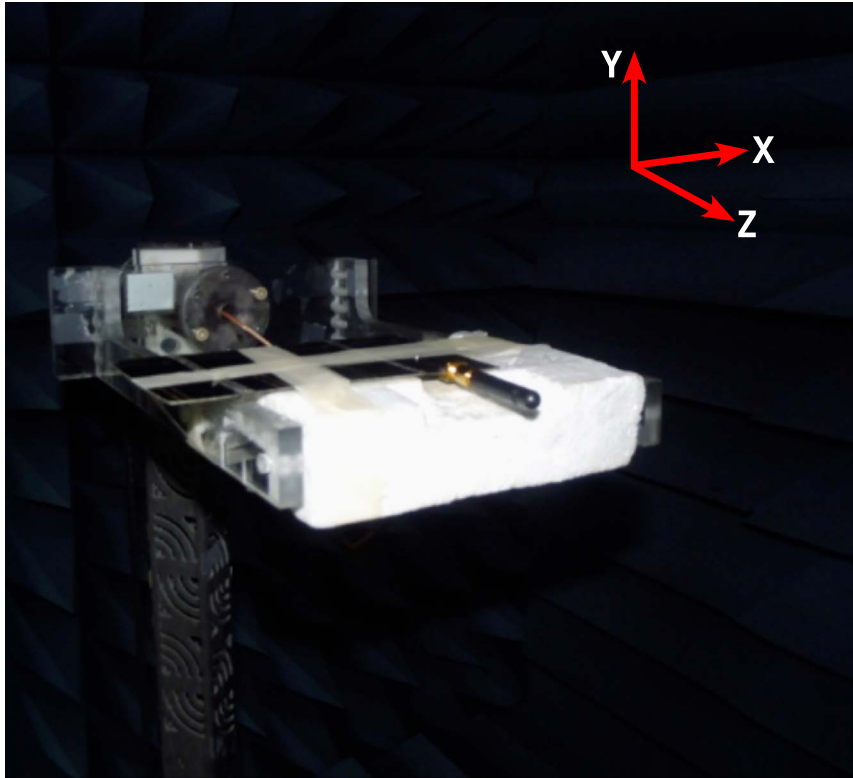

Figure 6. Average Gain of TG.22.0111

#### 4.6.1 Radiation Pattern





### 4.6.1 Radiation Pattern

#### XY-Plane

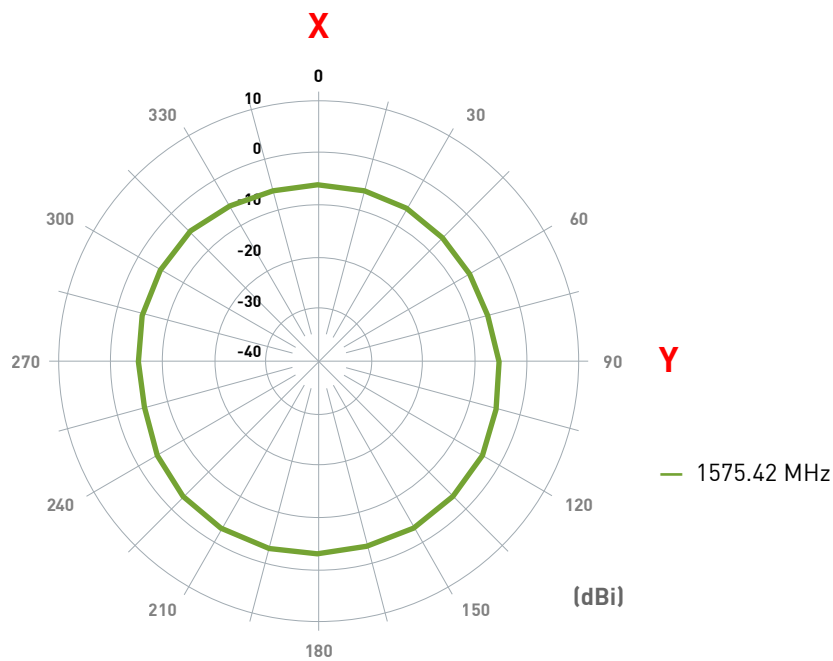
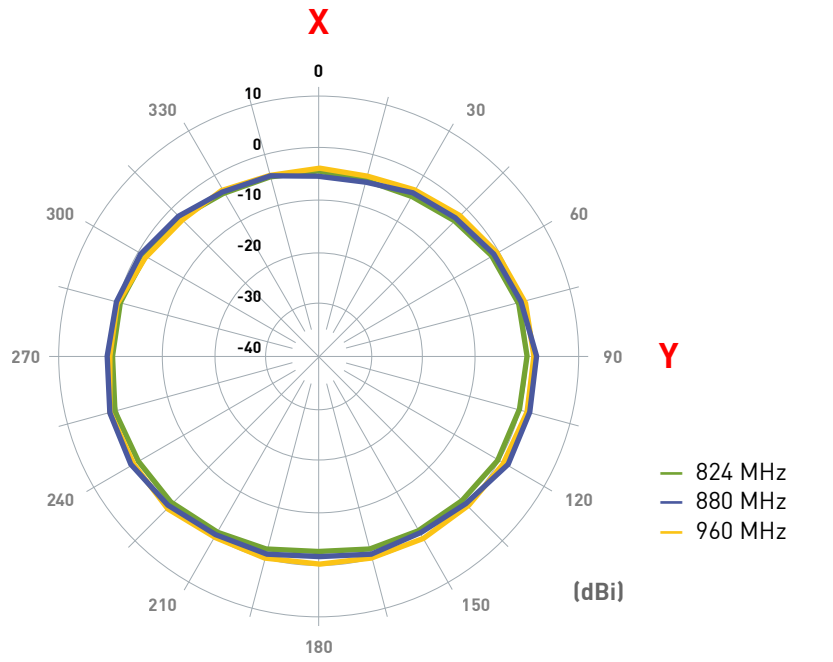

### 4.6.1 Radiation Pattern

#### XY-Plane

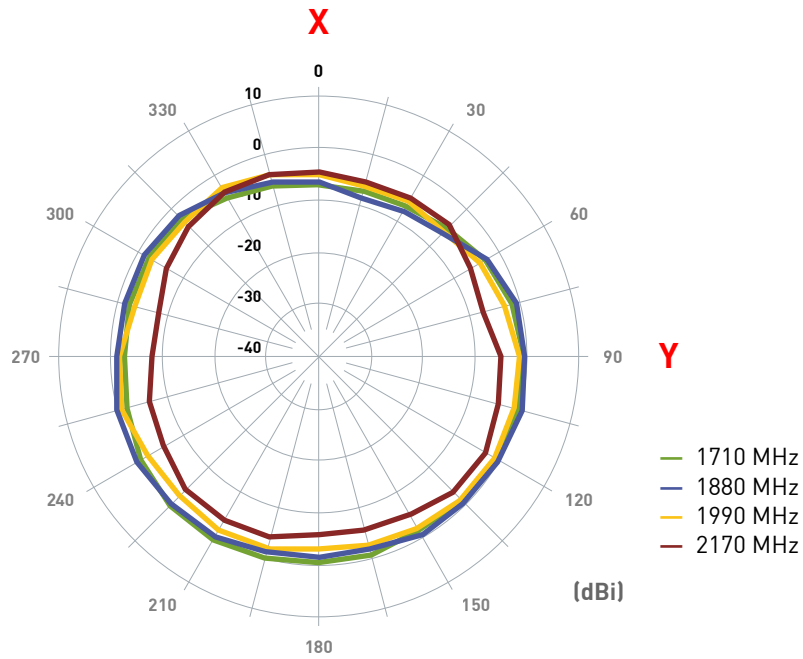

#### XZ-Plane

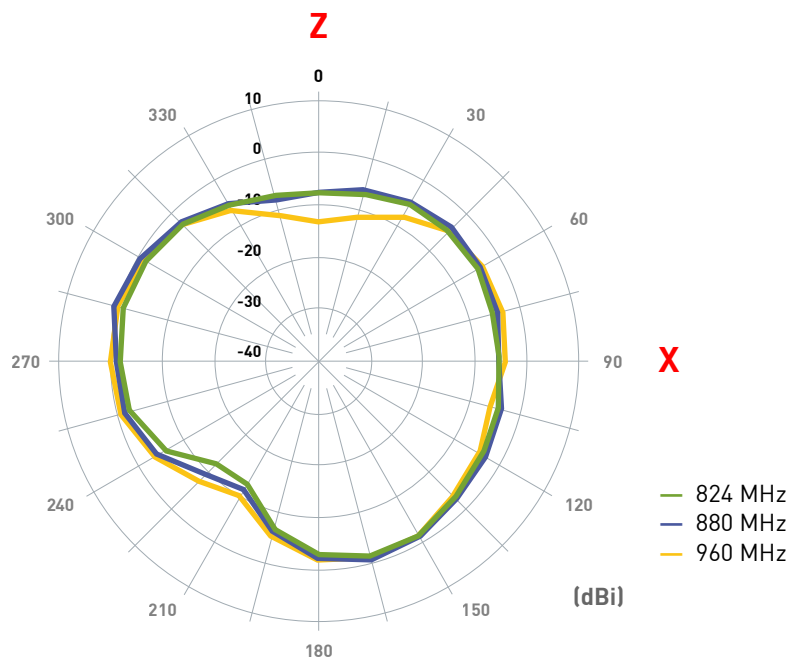

### 4.6.1 Radiation Pattern

#### XZ-Plane

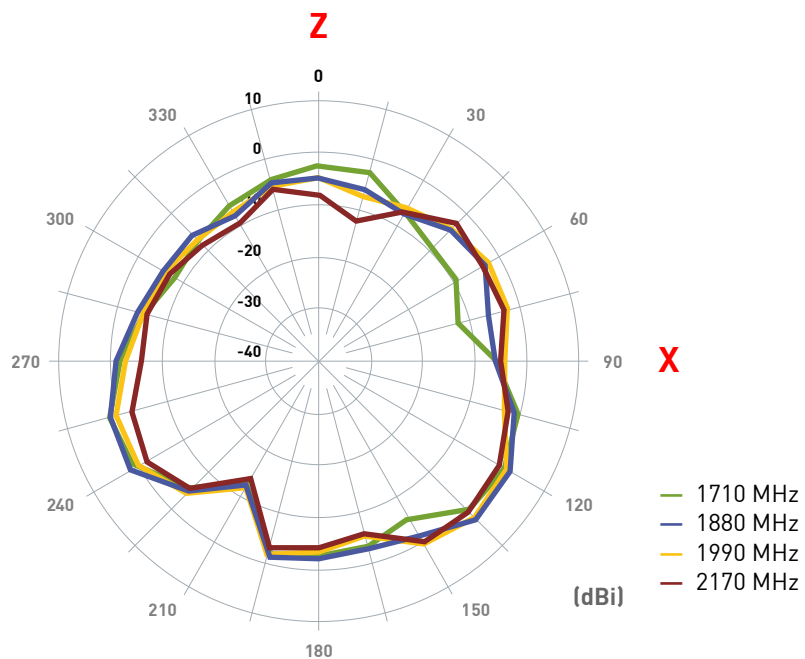
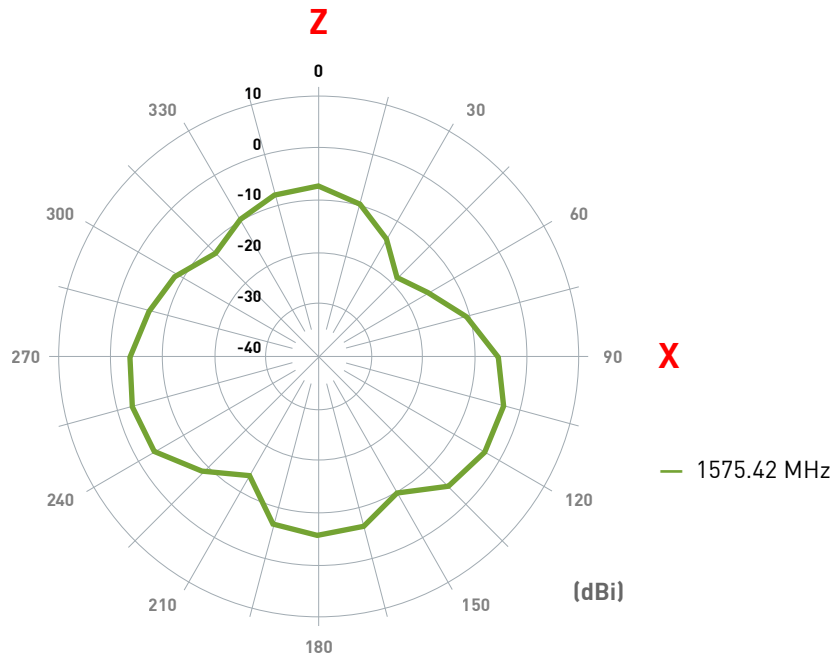

### 4.6.1 Radiation Pattern

#### YZ-Plane

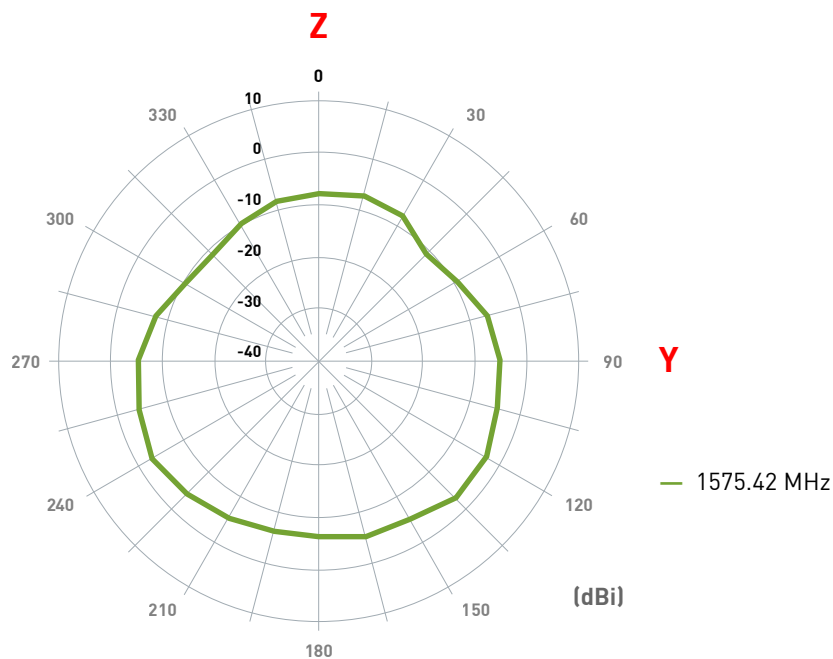
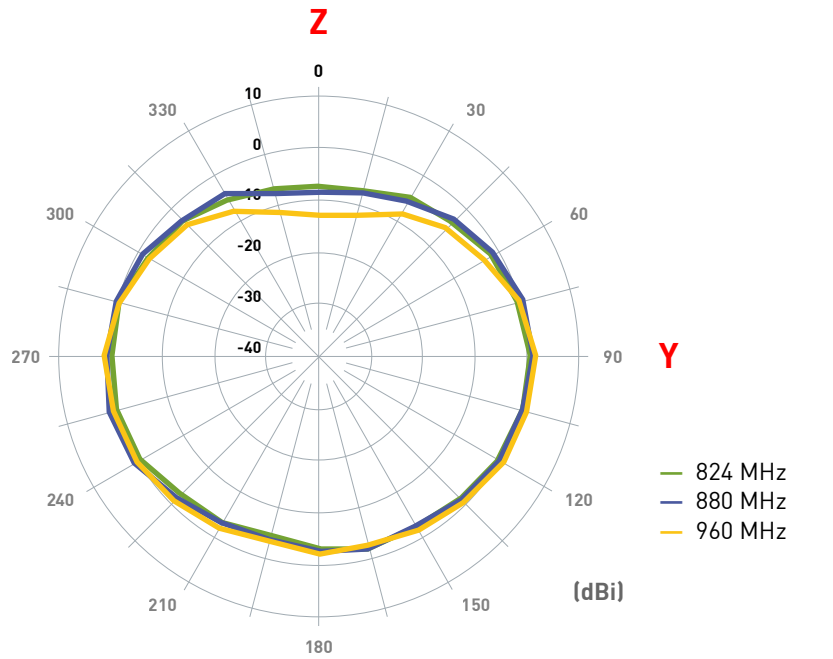

### 4.6.1 Radiation Pattern

#### YZ-Plane

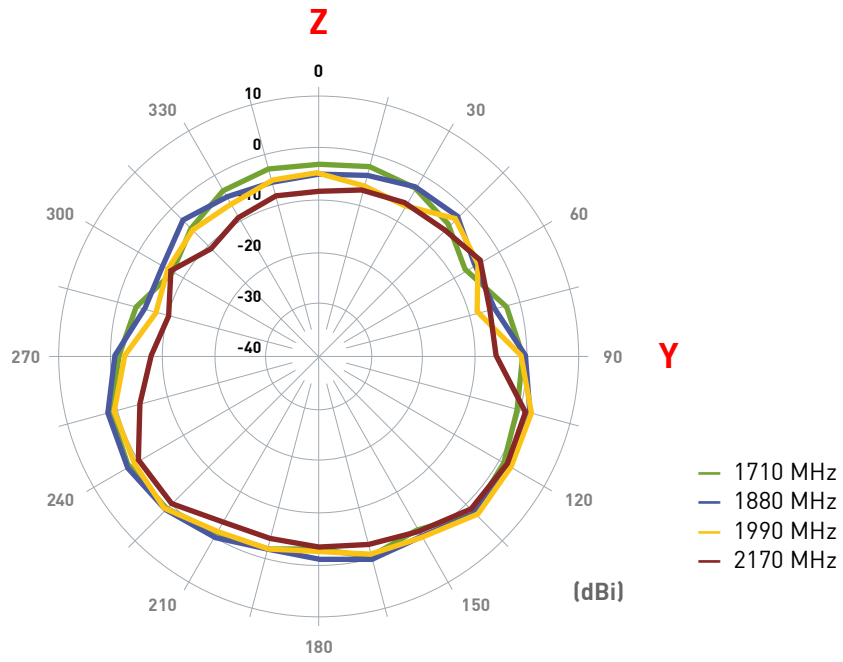

## 5. Drawing and Dimensions (unit: mm)

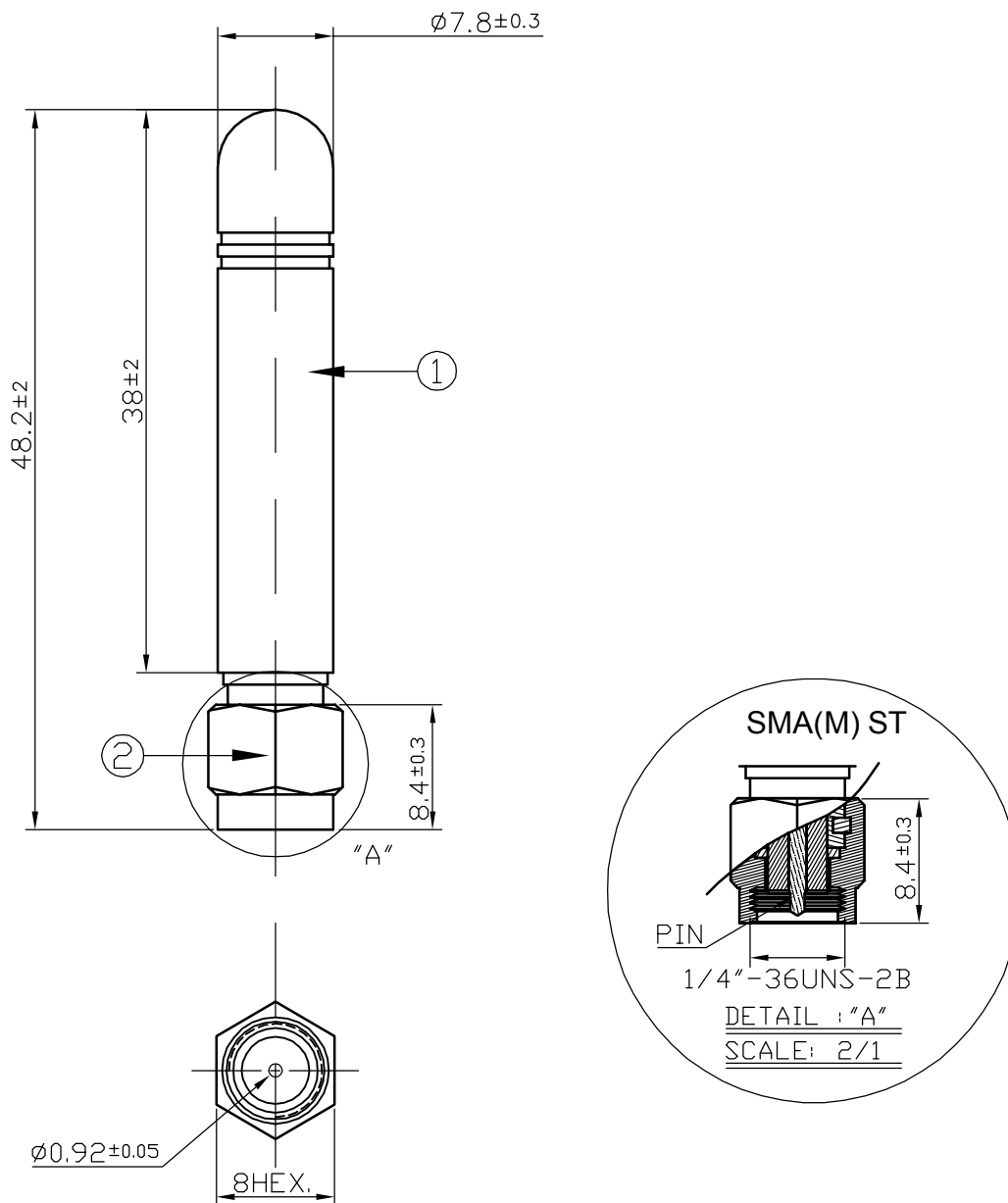

	Name	Material	Finish	Quantity
1	Antenna Housing	TPEE	White	1
2	SMA(M) ST	Brass	Gold	1

## 6. Packaging

- 1pc TG.22 per small PE Bag
- 100 small PE bags per large sealed PE bag

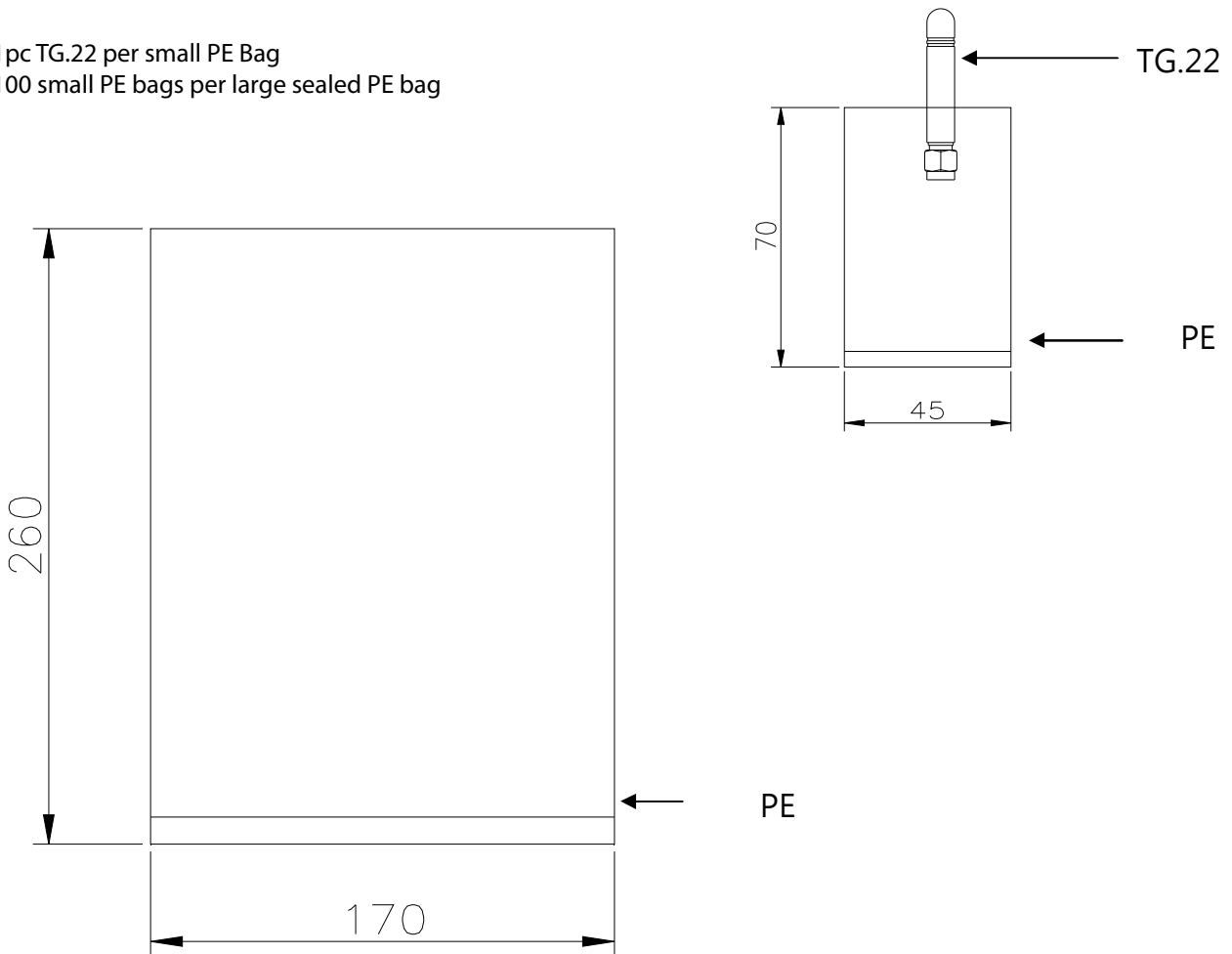

## 7. Installation

- 1) Use hand to screw the SMA connector.  
Tighten it until it feels a little tight.



- 2) Use torque wrench which has 0.9 Nm torque limit to tighten it.



- 3) Do not use normal wrench.





## 8. Application Note

This section, Taoglas provides the ground variation effects to TG.22.0111 antenna. Detail setup is setup as below.

### 8.1 Ground Plane Dimensions

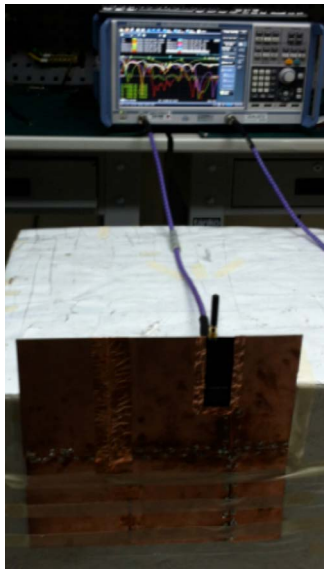

30cm \* 30cm



20cm \* 20cm

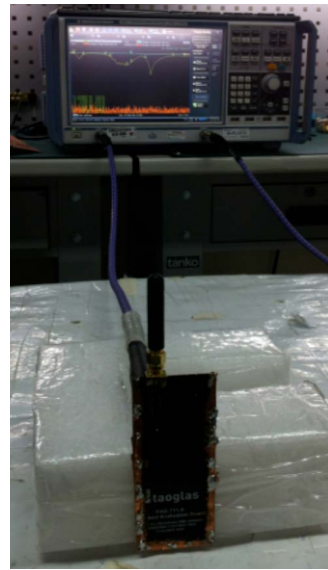

10cm \* 4cm

### 8.2 Return Loss

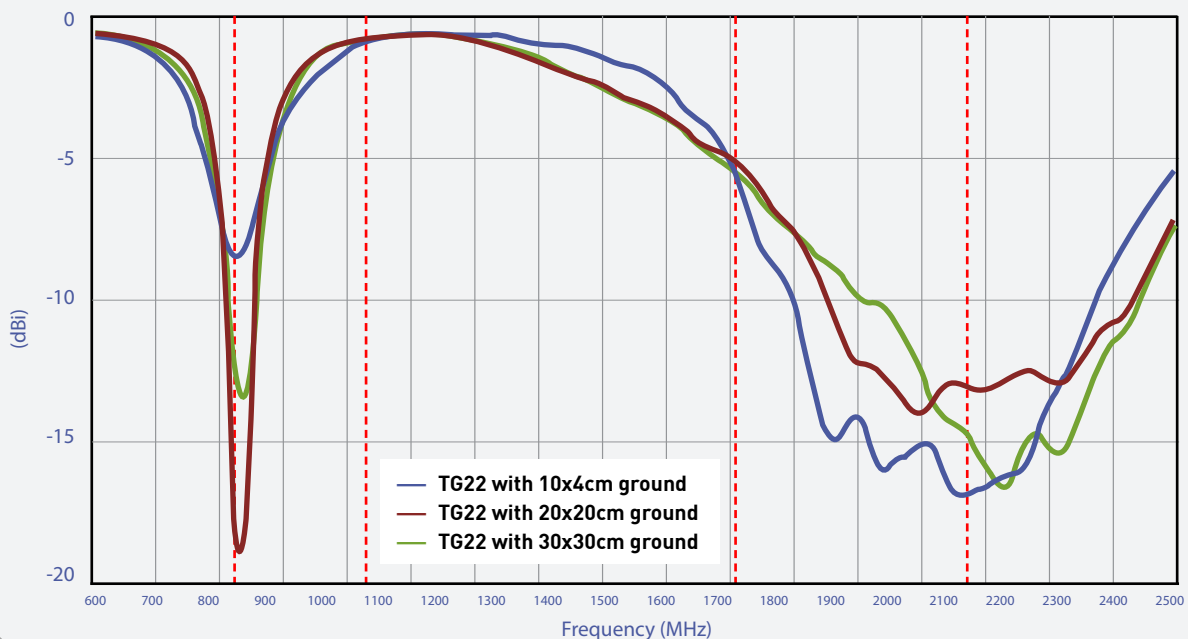

### 8.3 Efficiency (%)

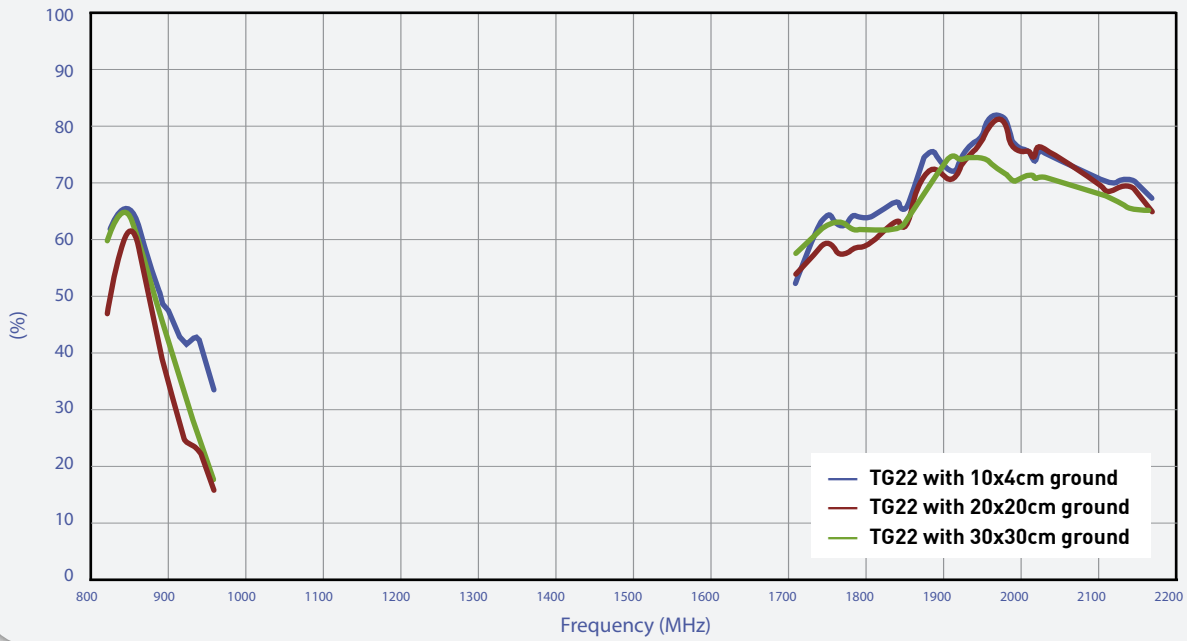

### 8.4 Peak Gain (dBi)

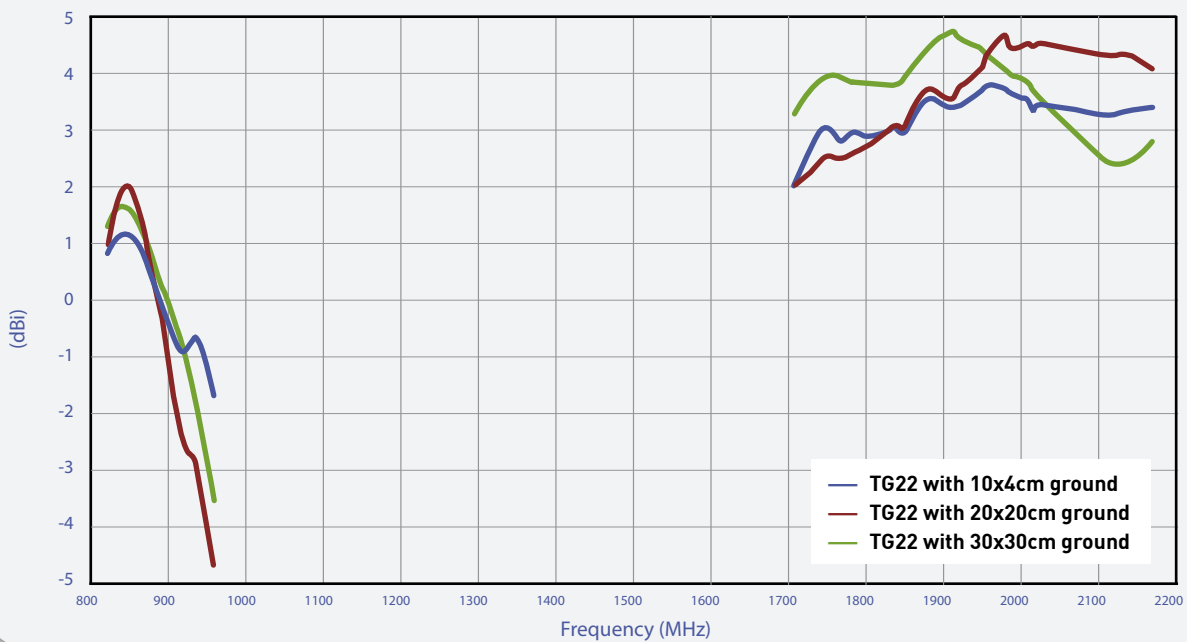

## 8.5 Radiation Pattern Measurement Setup

### 8.5.1 30cm\*30cm Ground Plane

#### Setup

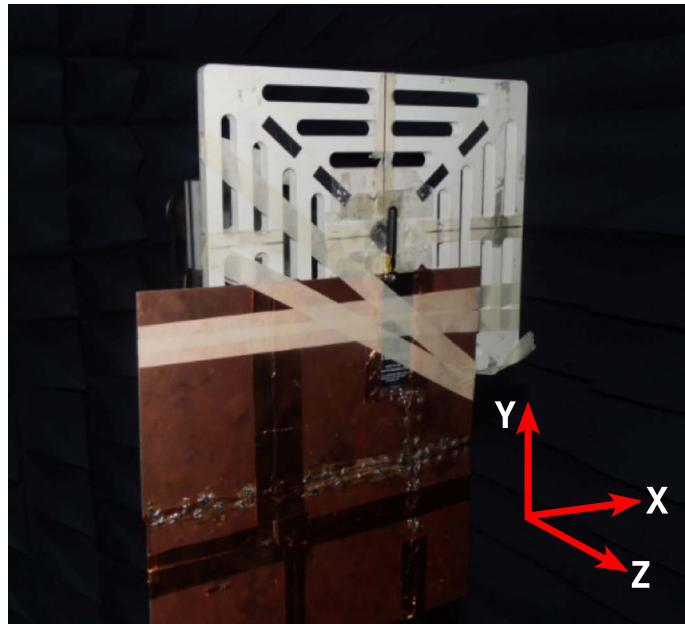

#### XY-Plane

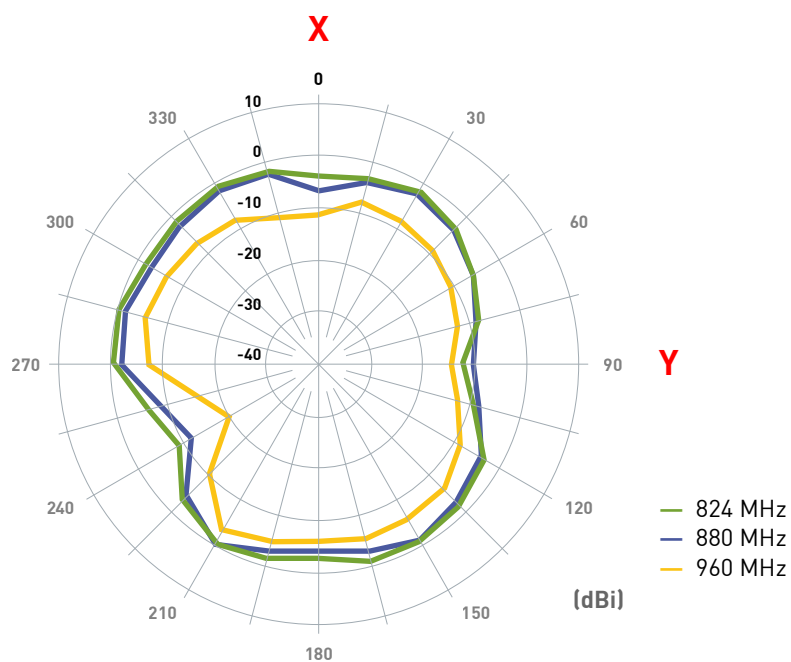

### 8.5.1 30cm\*30cm Ground Plane

#### XY-Plane

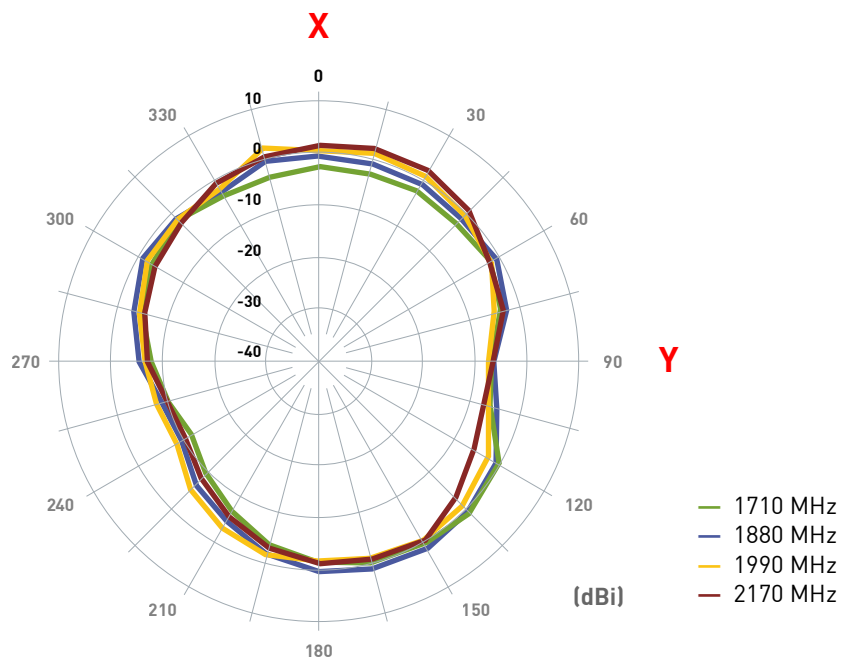
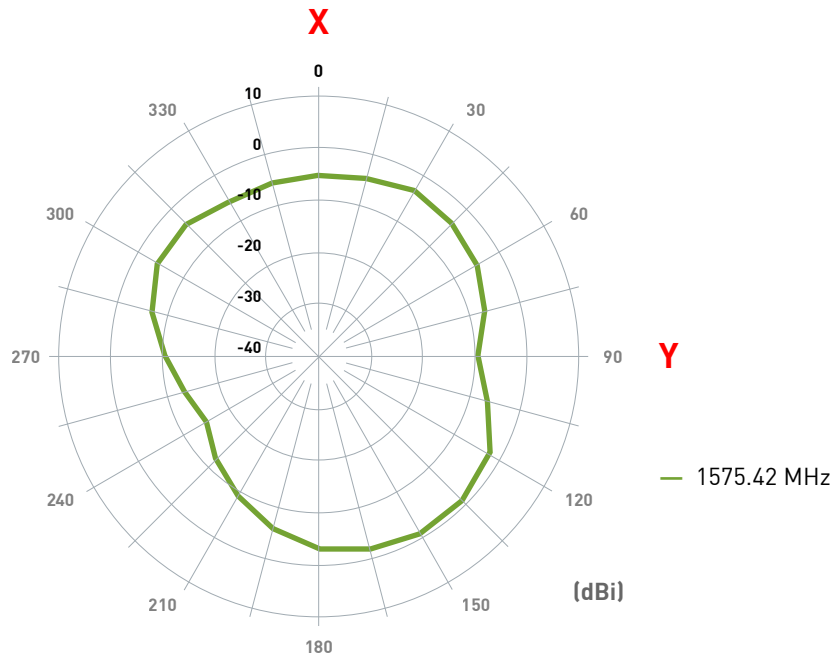

### 8.5.1 30cm\*30cm Ground Plane

#### XZ-Plane

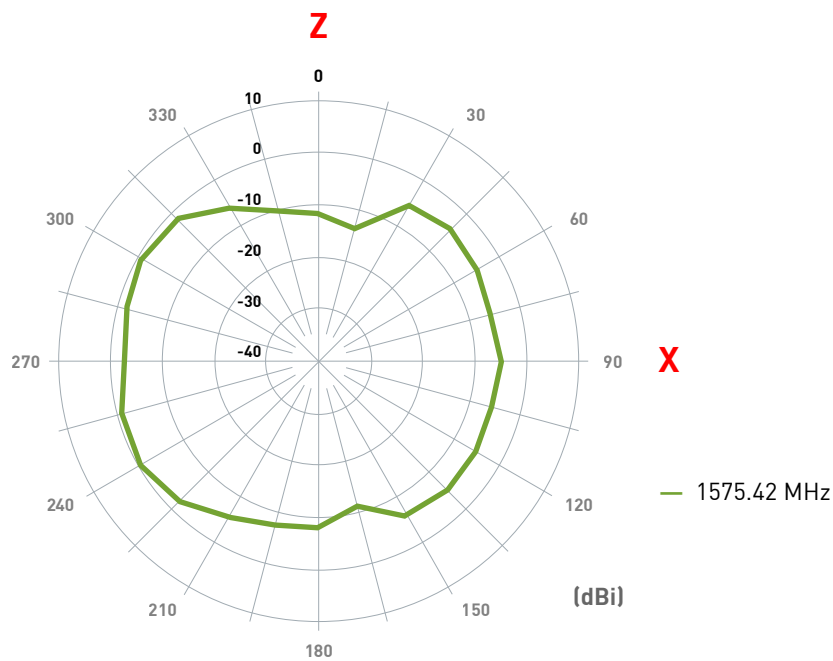
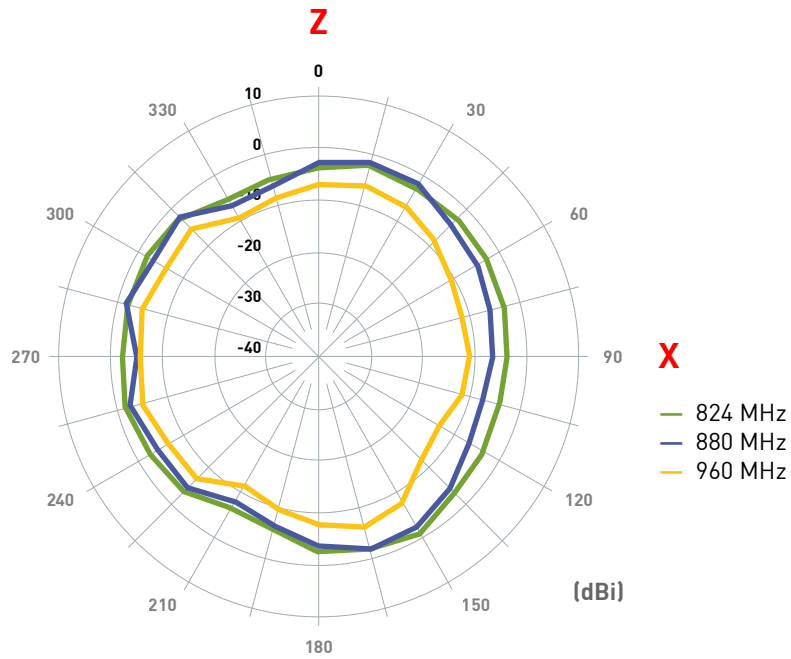

### 8.5.1 30cm\*30cm Ground Plane

#### XZ-Plane

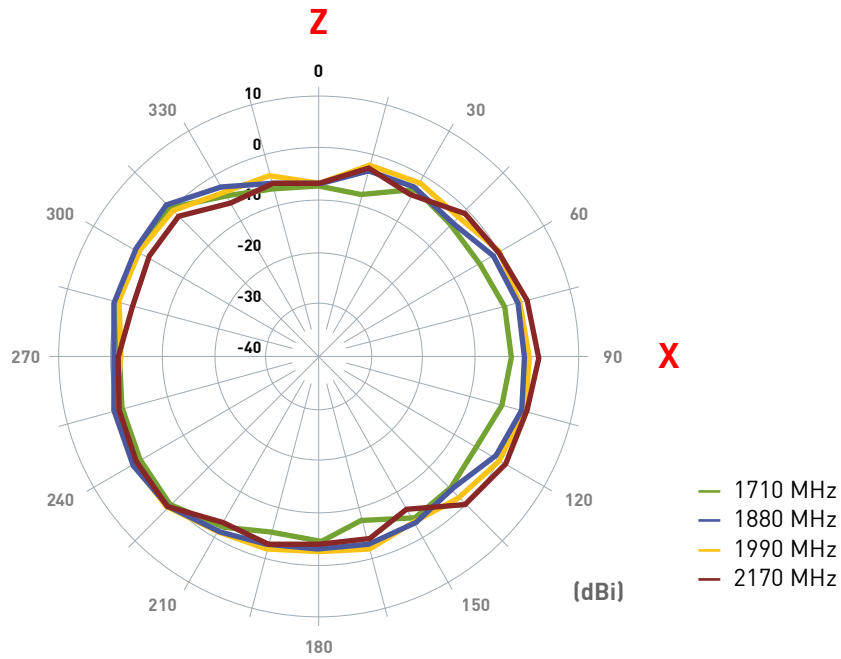

#### YZ-Plane

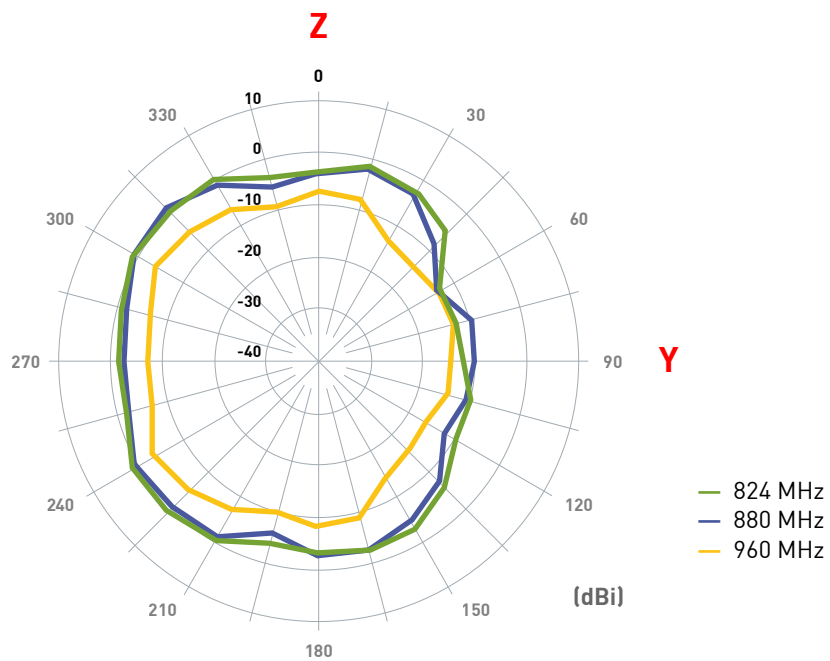

### 8.5.1 30cm\*30cm Ground Plane

#### YZ-Plane

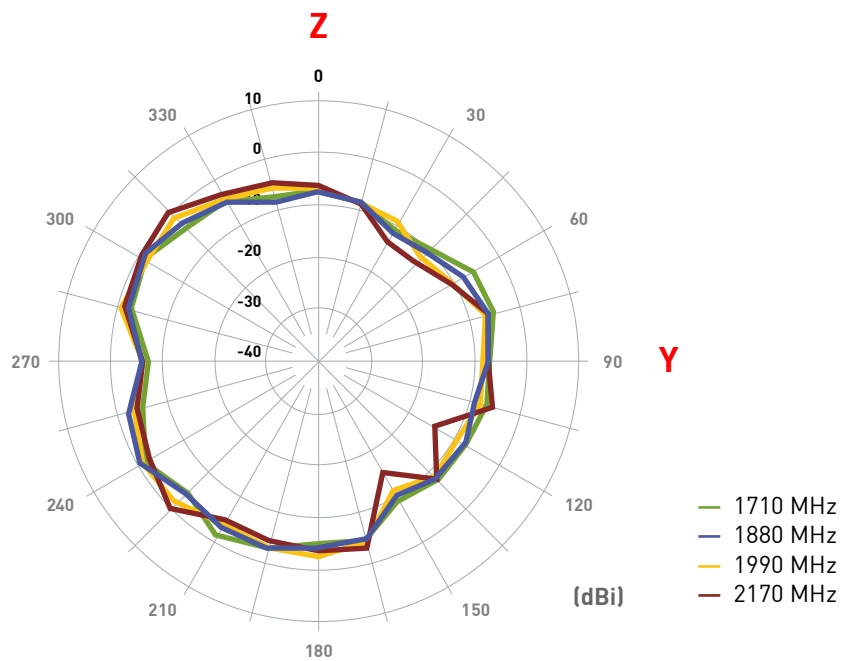
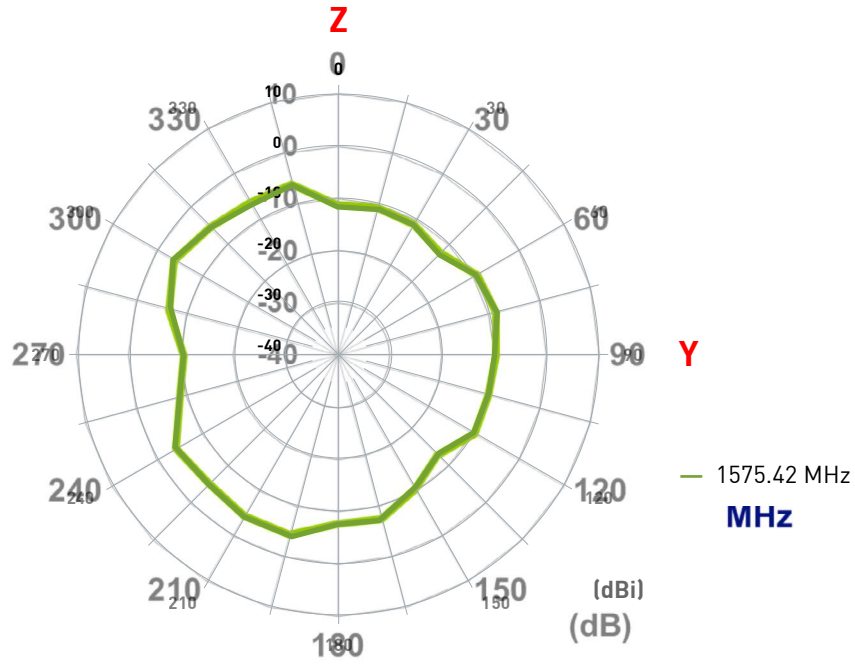

## 8.5.2 20cm\*20cm Ground Plane

### Setup

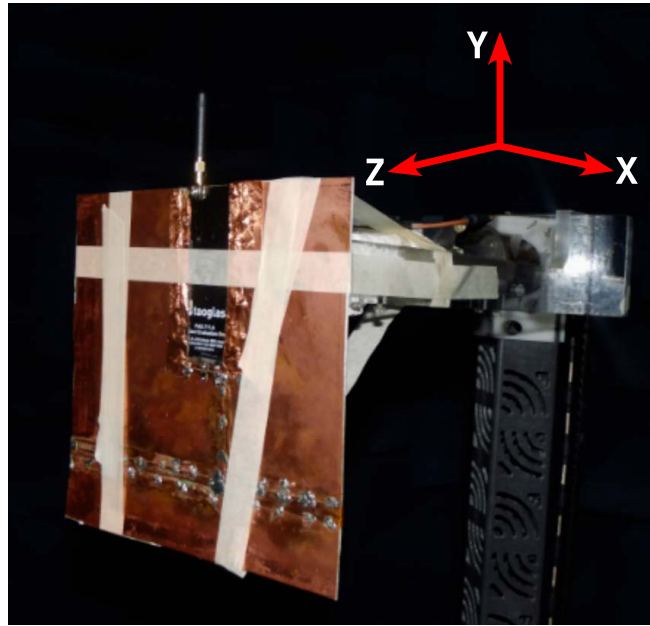

### XY-Plane

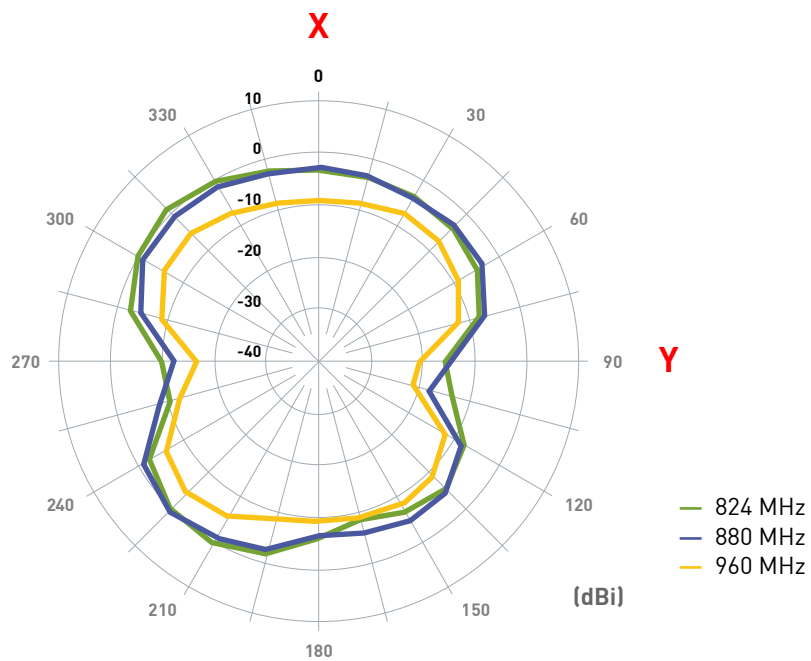



## 8.5.2 20cm\*20cm Ground Plane

### XY-Plane

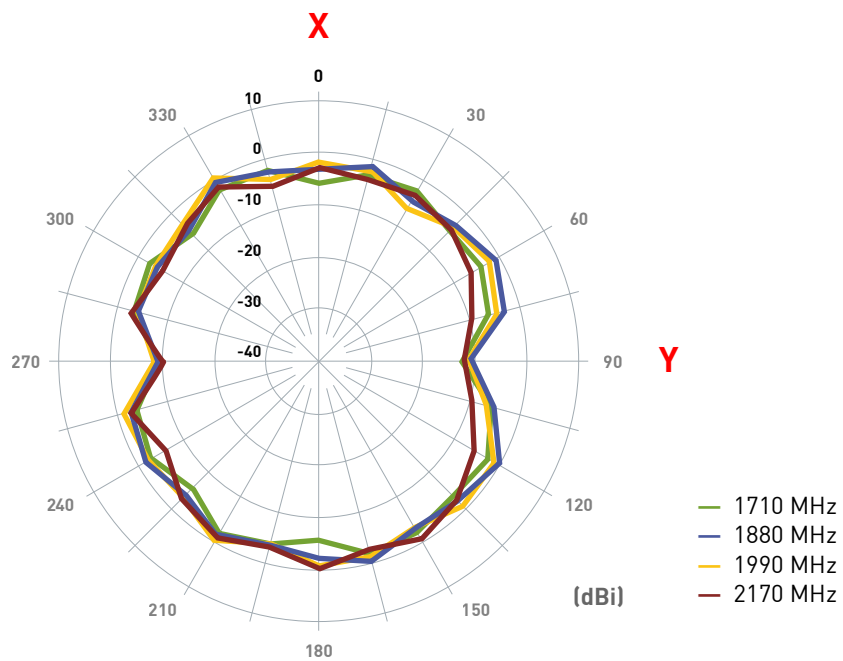
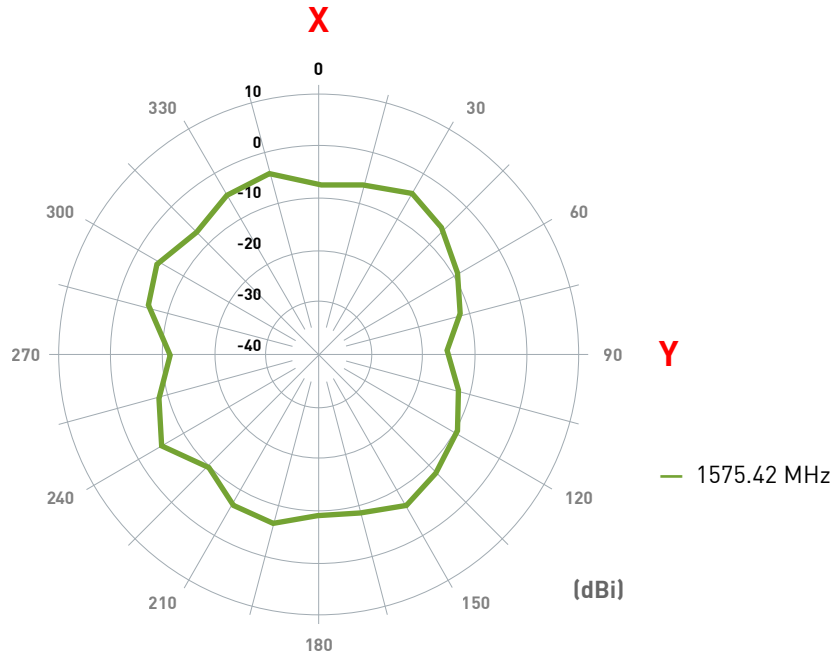

## 8.5.2 20cm\*20cm Ground Plane

### XZ-Plane

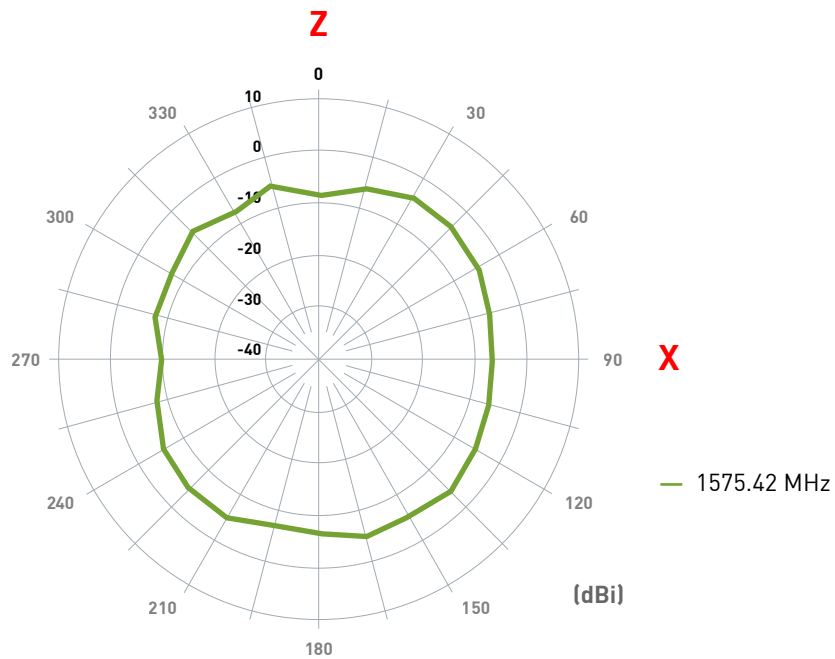
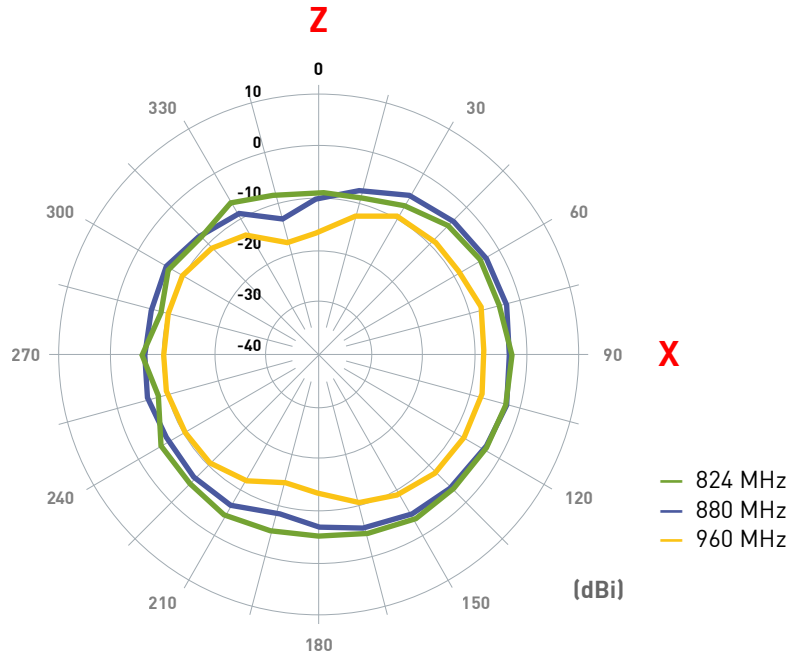

## 8.5.2 20cm\*20cm Ground Plane

### XZ-Plane

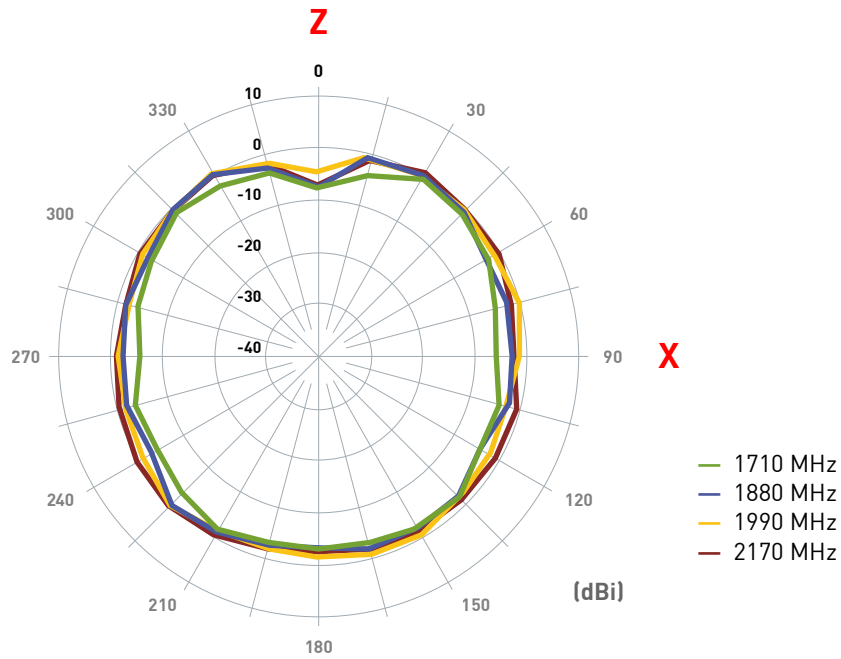

### YZ-Plane

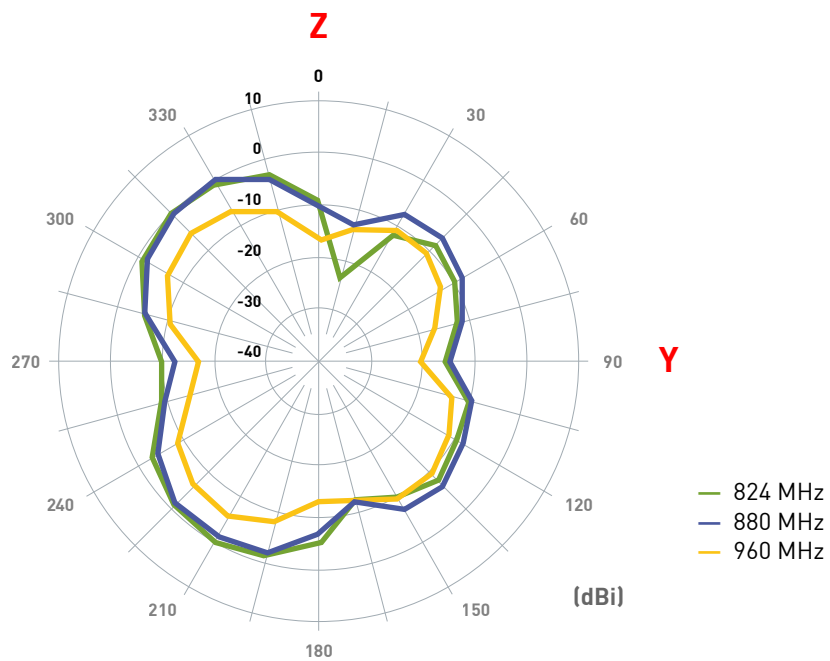

## 8.5.2 20cm\*20cm Ground Plane

### XZ-Plane

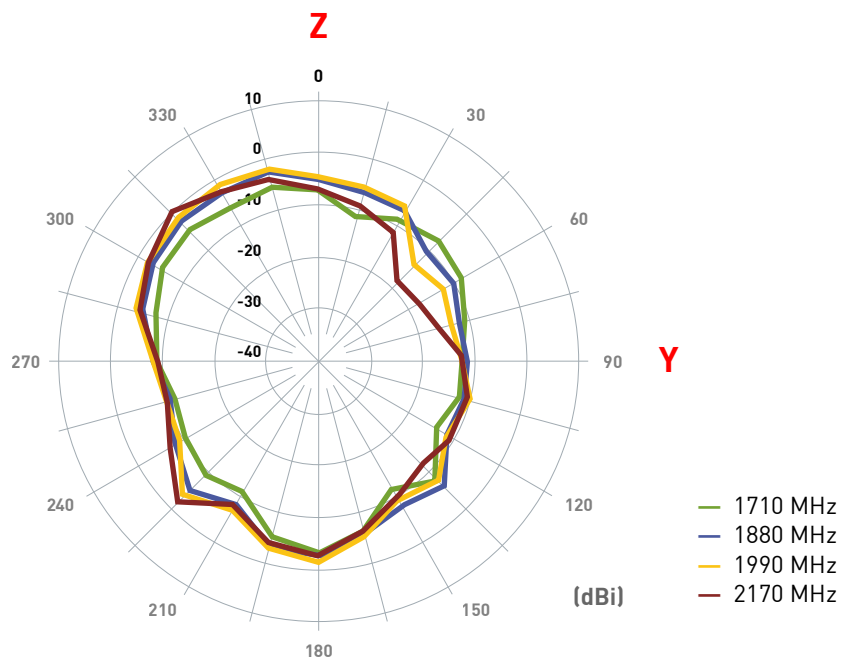
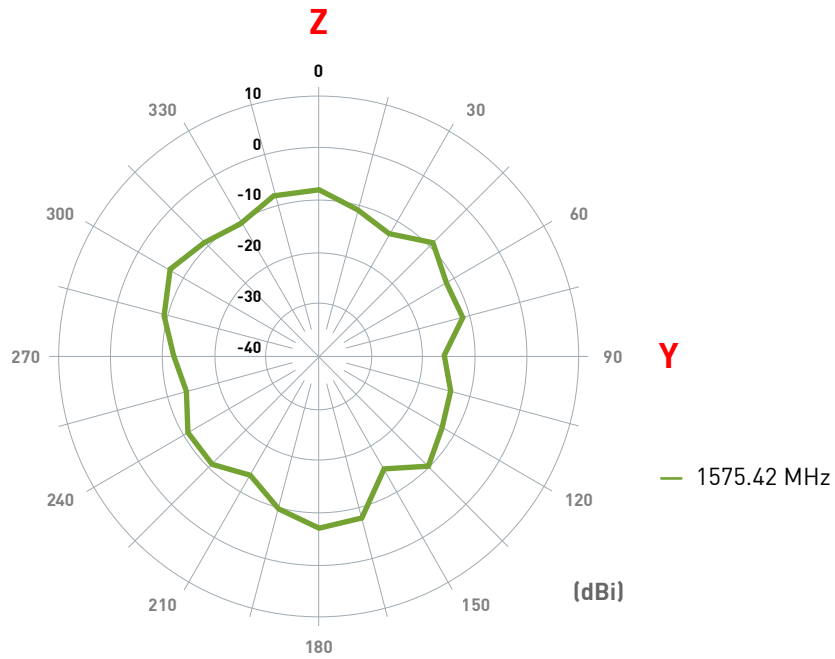

### 8.5.3 10cm\*4cm Ground Plane

#### Setup

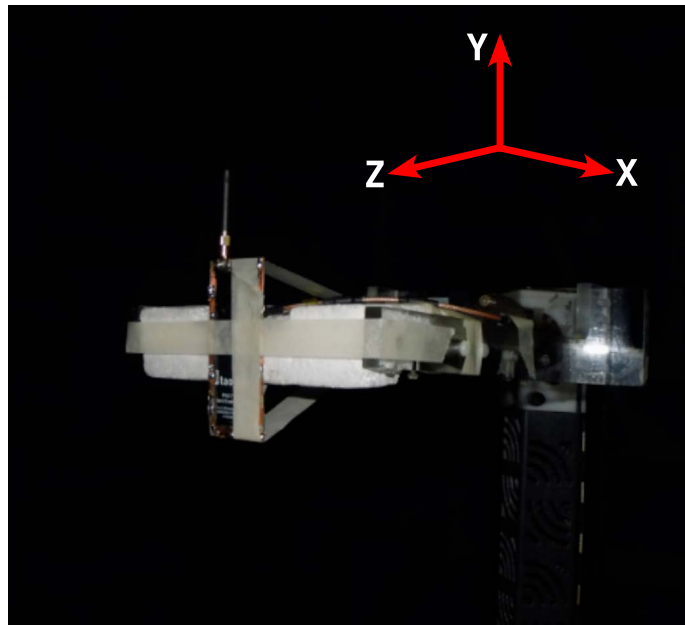

#### XY-Plane

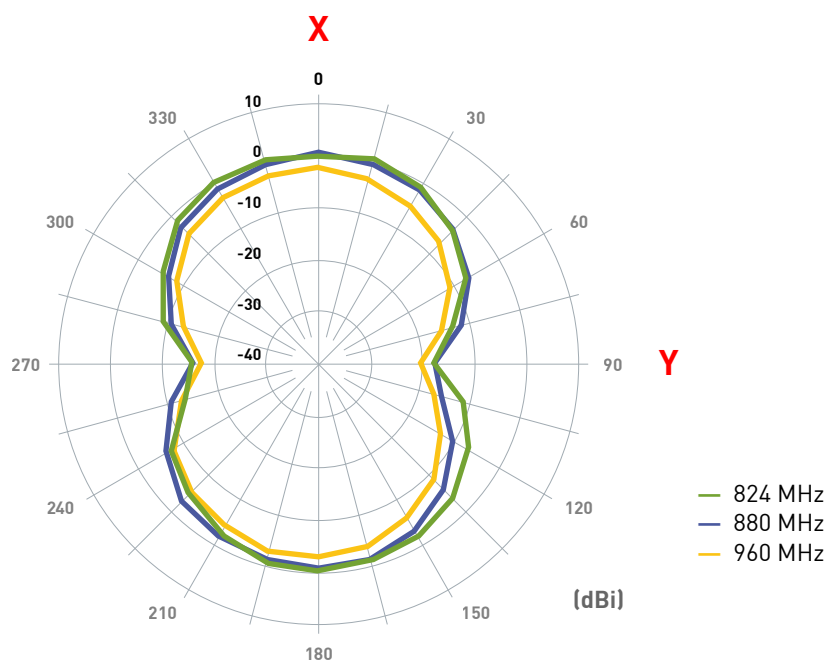

### 8.5.3 10cm\*4cm Ground Plane

#### XY-Plane

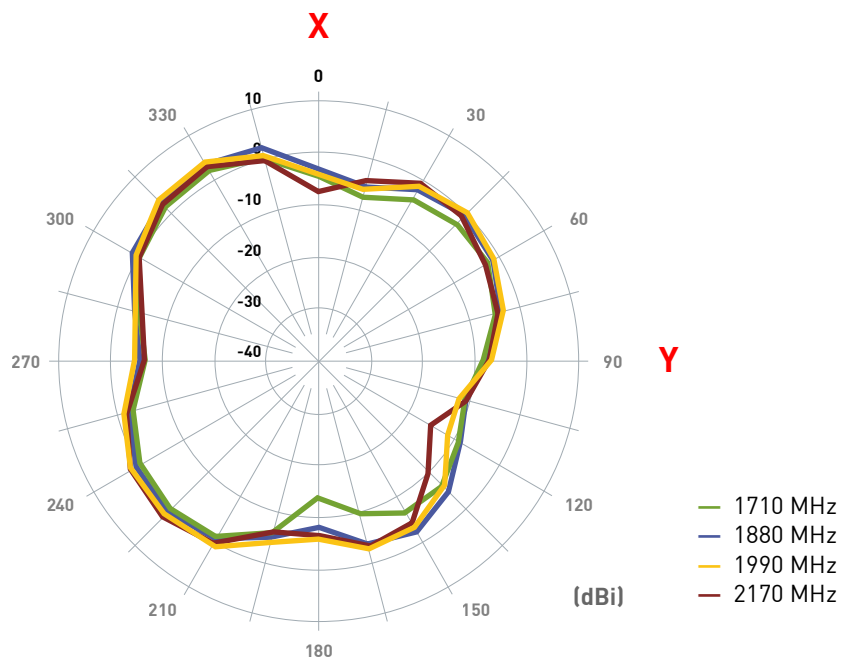
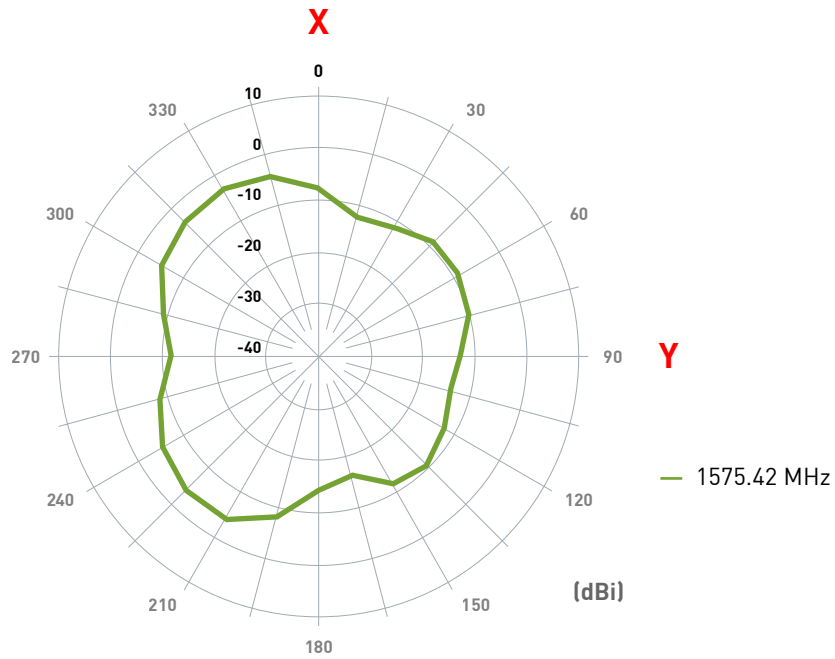

### 8.5.3 10cm\*4cm Ground Plane

#### XZ-Plane

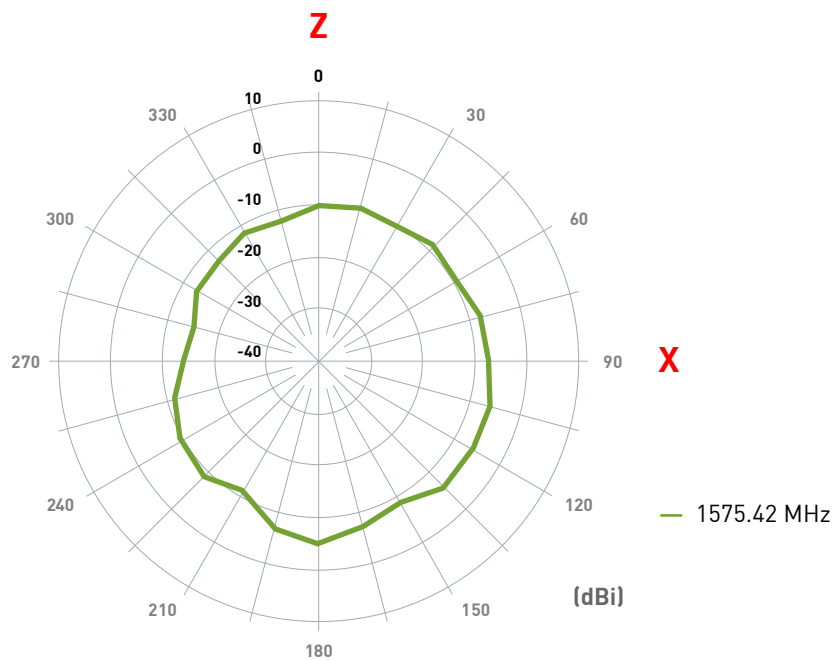
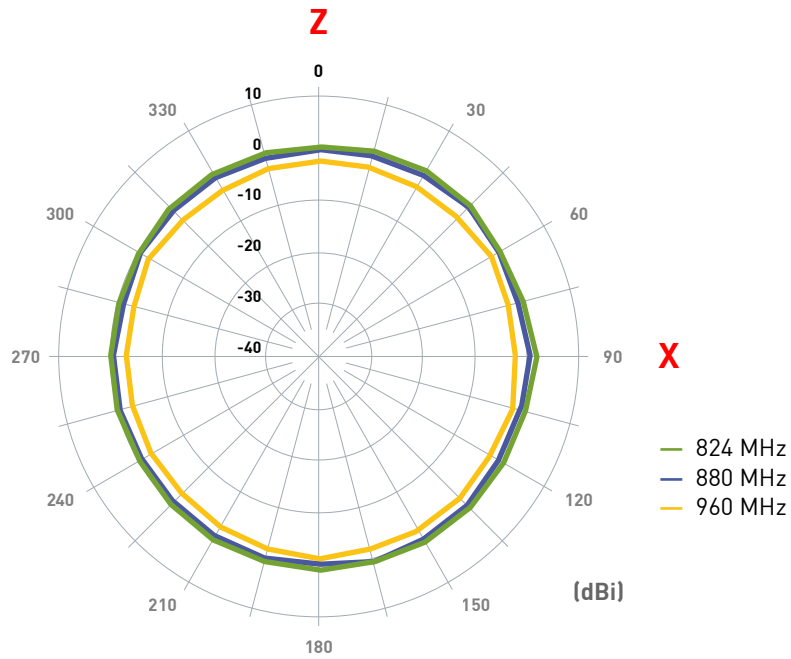

### 8.5.3 10cm\*4cm Ground Plane

#### XZ-Plane

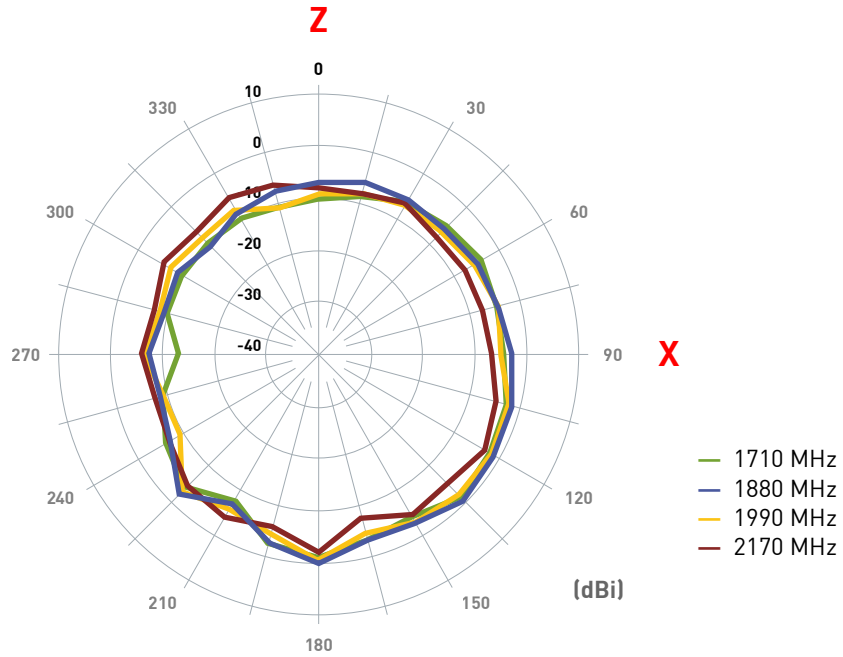

#### YZ-Plane

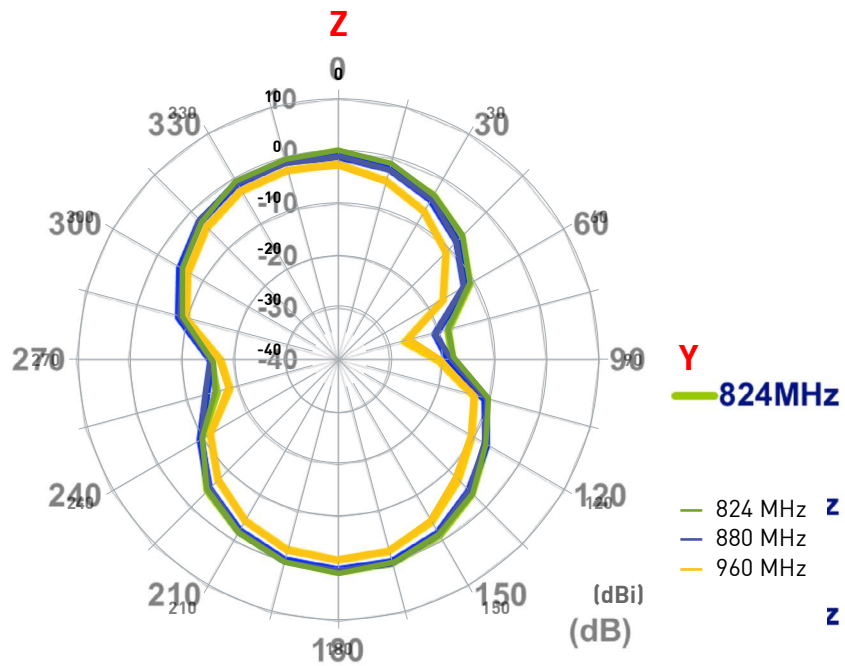



### 8.5.3 10cm\*4cm Ground Plane

#### YZ-Plane

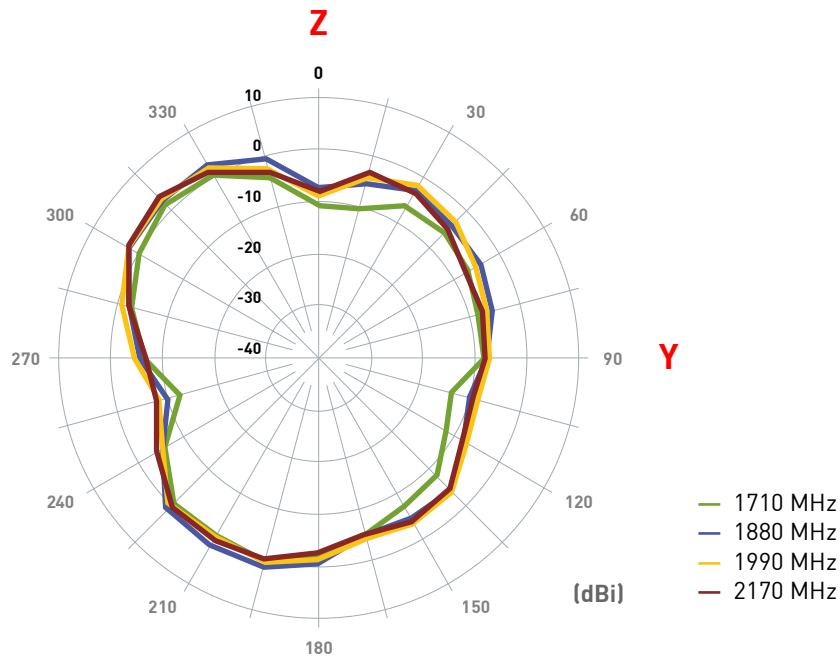
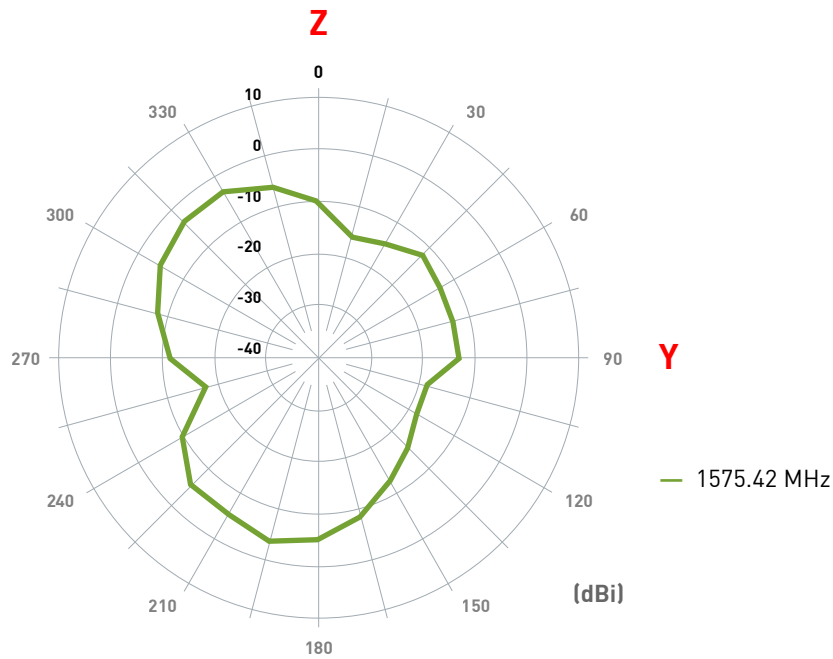

Taoglas makes no warranties based on the accuracy or completeness of the contents of this document and reserves the right to make changes to specifications and product descriptions at any time without

notice. Taoglas reserves all rights to this document and the information contained herein.

Reproduction, use or disclosure to third parties without express permission is strictly prohibited.

Copyright © Taoglas Ltd.