

FEATURES

Digitally/pin-programmable gain

$G = 1, 2, 4, 8, 16, 32, 64, \text{ or } 128$

Specified from -55°C to $+125^{\circ}\text{C}$

$50 \text{ nV}/^{\circ}\text{C}$ maximum input offset drift

$10 \text{ ppm}/^{\circ}\text{C}$ maximum gain drift

Excellent dc performance

80 dB minimum CMR, $G = 1$

$15 \mu\text{V}$ maximum input offset voltage

500 pA maximum bias current

$0.7 \mu\text{V p-p}$ noise (0.1 Hz to 10 Hz)

Good ac performance

2.7 MHz bandwidth, $G = 1$

$1.1 \text{ V}/\mu\text{s}$ slew rate

Rail-to-rail output

Shutdown/multiplex

Extra op amp

Single-supply range: 3 V to 6 V

Dual-supply range: $\pm 1.5 \text{ V}$ to $\pm 3 \text{ V}$

ENHANCED PRODUCT FEATURES

Supports defense and aerospace applications (AQEC standard)

Military temperature range (-55°C to $+125^{\circ}\text{C}$)

Controlled manufacturing baseline

One assembly/test site

One fabrication site

Enhanced product change notification

Qualification data available on request

GENERAL DESCRIPTION

The AD8231-EP is a low drift, rail-to-rail, instrumentation amplifier with software-programmable gains of 1, 2, 4, 8, 16, 32, 64, or 128. The gains are programmed via digital logic or pin strapping.

The AD8231-EP is ideal for applications that require precision performance over a wide temperature range, such as industrial temperature sensing and data logging. Because the gain setting resistors are internal, maximum gain drift is only $10 \text{ ppm}/^{\circ}\text{C}$ for gains of 1 to 32. Because of the auto-zero input stage, maximum input offset is $15 \mu\text{V}$ and maximum input offset drift is just $50 \text{ nV}/^{\circ}\text{C}$. CMRR is 80 dB for $G = 1$, increasing to 110 dB at higher gains.

Rev. 0

Information furnished by Analog Devices is believed to be accurate and reliable. However, no responsibility is assumed by Analog Devices for its use, nor for any infringements of patents or other rights of third parties that may result from its use. Specifications subject to change without notice. No license is granted by implication or otherwise under any patent or patent rights of Analog Devices. Trademarks and registered trademarks are the property of their respective owners.

FUNCTIONAL BLOCK DIAGRAM

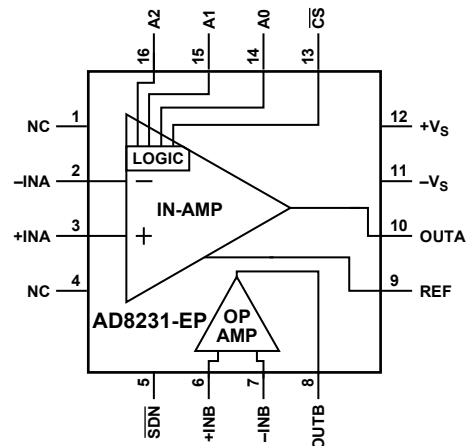

Figure 1.

Table 1. Instrumentation and Difference Amplifiers by Category

High Performance	Low Cost	High Voltage	Mil Grade	Low Power	Digital Gain
AD8221	AD623 ¹	AD628	AD620	AD627 ¹	AD8231 ¹
AD8220 ¹	AD8553 ¹	AD629	AD621		AD8250
AD8222			AD524		AD8251
AD8224 ¹			AD526		AD8555 ¹
			AD624		AD8556 ¹
					AD8557 ¹

¹ Rail-to-rail output.

The AD8231-EP also includes an uncommitted op amp that can be used for additional gain, differential signal driving, or filtering. Like the in-amp, the op amp has an auto-zero architecture, rail-to-rail input, and rail-to-rail output.

The AD8231-EP includes a shutdown feature that reduces current to a maximum of $1 \mu\text{A}$. In shutdown, both amplifiers also have a high output impedance, which allows easy multiplexing of multiple amplifiers without additional switches.

The AD8231-EP is specified over the military temperature range of -55°C to $+125^{\circ}\text{C}$. It is available in a $4 \text{ mm} \times 4 \text{ mm}$ 16-lead LFCSP.

Additional application and technical information can be found in the [AD8231](#) data sheet.

TABLE OF CONTENTS

Features	1	ESD Caution.....	7
Enhanced Product Features	1	Pin Configuration and Function Descriptions.....	8
Functional Block Diagram	1	Typical Performance Characteristics	8
General Description	1	Instrumentation Amplifier Performance Curves.....	9
Revision History	2	Operational Amplifier Performance Curves	15
Specifications.....	3	Performance Curves Valid for Both Amplifiers.....	17
Absolute Maximum Ratings.....	7	Outline Dimensions	18
Thermal Resistance	7	Ordering Guide	18
Maximum Power Dissipation	7		

REVISION HISTORY

5/11—Revision 0: Initial Version

SPECIFICATIONS

$V_S = 5\text{ V}$, $V_{REF} = 2.5\text{ V}$, $G = 1$, $R_L = 10\text{ k}\Omega$, $T_A = 25^\circ\text{C}$, unless otherwise noted.

Table 2.

Parameter	Test Conditions/Comments	Min	Typ	Max	Unit
INSTRUMENTATION AMPLIFIER					
Offset Voltage	$V_{OS\ RTI} = V_{OSI} + V_{OSO}/G$				
Input Offset, V_{OSI}			4	15	μV
Average Temperature Drift	$T_A = -55^\circ\text{C}$ to $+125^\circ\text{C}$		0.01	0.05	$\mu\text{V}/^\circ\text{C}$
Output Offset, V_{OSO}			15	30	μV
Average Temperature Drift	$T_A = -55^\circ\text{C}$ to $+125^\circ\text{C}$		0.05	0.5	$\mu\text{V}/^\circ\text{C}$
Input Currents					
Input Bias Current			250	500	pA
Input Offset Current	$T_A = -55^\circ\text{C}$ to $+125^\circ\text{C}$		20	100	pA
	$T_A = -55^\circ\text{C}$ to $+125^\circ\text{C}$			0.5	nA
Gains	1, 2, 4, 8, 16, 32, 64, or 128				
Gain Error					
G = 1				0.05	%
G = 2 to 128				0.8	%
Gain Drift	$T_A = -55^\circ\text{C}$ to $+125^\circ\text{C}$				
G = 1 to 32			3	10	ppm/ $^\circ\text{C}$
G = 64			4	20	ppm/ $^\circ\text{C}$
G = 128			10	30	ppm/ $^\circ\text{C}$
Linearity	0.2 V to 4.8 V, 10 k Ω load		3		ppm
	0.2 V to 4.8 V, 2 k Ω load		5		ppm
CMRR					
G = 1		80			dB
G = 2		86			dB
G = 4		92			dB
G = 8		98			dB
G = 16		104			dB
G = 32		110			dB
G = 64		110			dB
G = 128		110			dB
Noise	$e_n = \sqrt{(e_{ni}^2 + (e_{no}/G)^2)}$, $V_{IN+}, V_{IN-} = 2.5\text{ V}$				
Input Voltage Noise, e_{ni}	f = 1 kHz		32		nV/ $\sqrt{\text{Hz}}$
	f = 1 kHz, $T_A = -55^\circ\text{C}$		27		nV/ $\sqrt{\text{Hz}}$
	f = 1 kHz, $T_A = 125^\circ\text{C}$		39		nV/ $\sqrt{\text{Hz}}$
Output Voltage Noise, e_{no}	f = 0.1 Hz to 10 Hz		0.7		$\mu\text{V p-p}$
	f = 1 kHz		58		nV/ $\sqrt{\text{Hz}}$
	f = 1 kHz, $T_A = -55^\circ\text{C}$		50		nV/ $\sqrt{\text{Hz}}$
	f = 1 kHz, $T_A = 125^\circ\text{C}$		70		nV/ $\sqrt{\text{Hz}}$
	f = 0.1 Hz to 10 Hz		1.1		$\mu\text{V p-p}$
Current Noise	f = 10 Hz		20		fA/ $\sqrt{\text{Hz}}$
Other Input Characteristics					
Common-Mode Input Impedance			10 5		G Ω pF
Power Supply Rejection Ratio		100	115		dB
Input Operating Voltage Range		0.05		4.95	V
Reference Input					
Input Impedance			28		k Ω
Voltage Range		-0.2		+5.2	V

AD8231-EP

Parameter	Test Conditions/Comments	Min	Typ	Max	Unit
Dynamic Performance					
Bandwidth					
G = 1			2.7		MHz
G = 2			2.5		MHz
Gain Bandwidth Product					
G = 4 to 128			7		MHz
Slew Rate					
			1.1		V/μs
Output Characteristics					
Output Voltage High					
	R _L = 100 kΩ to ground	4.9	4.94		V
	R _L = 10 kΩ to ground	4.8	4.88		V
Output Voltage Low					
	R _L = 100 kΩ to 5 V		60	100	mV
	R _L = 10 kΩ to 5 V		80	200	mV
Short-Circuit Current					
			70		mA
Digital Interface					
Input Voltage Low					
	T _A = -55°C to +125°C			1.0	V
Input Voltage High					
	T _A = -55°C to +125°C	4.0			V
Setup Time to \overline{CS} High					
	T _A = -55°C to +125°C	50			ns
Hold Time after \overline{CS} High					
	T _A = -55°C to +125°C	20			ns
OPERATIONAL AMPLIFIER					
Input Characteristics					
Offset Voltage, V_{OS}					
Temperature Drift	T _A = -55°C to +125°C		5	15	μV
Input Bias Current					
	T _A = -55°C to +125°C		250	500	pA
Input Offset Current					
	T _A = -55°C to +125°C		20	100	pA
	T _A = -55°C to +125°C			0.5	nA
Input Voltage Range					
		0.05		4.95	V
Open-Loop Gain					
		100	120		V/mV
Common-Mode Rejection Ratio					
		100	120		dB
Power Supply Rejection Ratio					
		100	110		dB
Voltage Noise Density					
			20		nV/√Hz
Voltage Noise					
	f = 0.1 Hz to 10 Hz		0.4		μV p-p
Dynamic Performance					
Gain Bandwidth Product					
			1		MHz
Slew Rate					
			0.5		V/μs
Output Characteristics					
Output Voltage High					
	R _L = 100 kΩ to ground	4.9	4.96		V
	R _L = 10 kΩ to ground	4.8	4.92		V
Output Voltage Low					
	R _L = 100 kΩ to 5 V		60	100	mV
	R _L = 10 kΩ to 5 V		80	200	mV
Short-Circuit Current					
			70		mA
BOTH AMPLIFIERS					
Power Supply					
Quiescent Current					
			4	5	mA
Quiescent Current (Shutdown)					
			0.01	1	μA

$V_S = 3.0\text{ V}$, $V_{REF} = 1.5\text{ V}$, $T_A = 25^\circ\text{C}$, $G = 1$, $R_L = 10\text{ k}\Omega$, unless otherwise noted.

Table 3.

Parameter	Conditions	Min	Typ	Max	Unit
INSTRUMENTATION AMPLIFIER					
Offset Voltage	$V_{OS\ RTI} = V_{OSI} + V_{OSO}/G$				
Input Offset, V_{OSI}			4	15	μV
Average Temperature Drift			0.01	0.05	$\mu\text{V}/^\circ\text{C}$
Output Offset, V_{OSO}			15	30	μV
Average Temperature Drift			0.05	0.5	$\mu\text{V}/^\circ\text{C}$
Input Currents					
Input Bias Current			250	500	pA
Input Offset Current	$T_A = -55^\circ\text{C}$ to $+125^\circ\text{C}$		20	100	pA
	$T_A = -55^\circ\text{C}$ to $+125^\circ\text{C}$			5	nA
	$T_A = -55^\circ\text{C}$ to $+125^\circ\text{C}$			0.5	nA
Gains	1, 2, 4, 8, 16, 32, 64, or 128				
Gain Error					
$G = 1$				0.05	%
$G = 2$ to 128				0.8	%
Gain Drift	$T_A = -55^\circ\text{C}$ to $+125^\circ\text{C}$				
$G = 1$ to 32			3	10	$\text{ppm}/^\circ\text{C}$
$G = 64$			4	20	$\text{ppm}/^\circ\text{C}$
$G = 128$			10	30	$\text{ppm}/^\circ\text{C}$
CMRR					
$G = 1$		80			dB
$G = 2$		86			dB
$G = 4$		92			dB
$G = 8$		98			dB
$G = 16$		104			dB
$G = 32$		110			dB
$G = 64$		110			dB
$G = 128$		110			dB
Noise	$e_n = \sqrt{(e_{ni})^2 + (e_{no}/G)^2}$ $V_{IN+}, V_{IN-} = 2.5\text{ V}$, $T_A = 25^\circ\text{C}$				
Input Voltage Noise, e_{ni}	$f = 1\text{ kHz}$		40		$\text{nV}/\sqrt{\text{Hz}}$
	$f = 1\text{ kHz}$, $T_A = -55^\circ\text{C}$		35		$\text{nV}/\sqrt{\text{Hz}}$
	$f = 1\text{ kHz}$, $T_A = 125^\circ\text{C}$		48		$\text{nV}/\sqrt{\text{Hz}}$
Output Voltage Noise, e_{no}	$f = 0.1\text{ Hz}$ to 10 Hz		0.8		$\mu\text{V p-p}$
	$f = 1\text{ kHz}$		72		$\text{nV}/\sqrt{\text{Hz}}$
	$f = 1\text{ kHz}$, $T_A = -55^\circ\text{C}$		62		$\text{nV}/\sqrt{\text{Hz}}$
	$f = 1\text{ kHz}$, $T_A = 125^\circ\text{C}$		83		$\text{nV}/\sqrt{\text{Hz}}$
	$f = 0.1\text{ Hz}$ to 10 Hz		1.4		$\mu\text{V p-p}$
Current Noise	$f = 10\text{ Hz}$		20		$\text{fA}/\sqrt{\text{Hz}}$
Other Input Characteristics					
Common-Mode Input Impedance			10 5		$\text{G}\Omega \text{pF}$
Power Supply Rejection Ratio		100	115		dB
Input Operating Voltage Range		0.05		2.95	V
Reference Input					
Input Impedance			28		$\text{k}\Omega \text{pF}$
Voltage Range		-0.2		+3.2	V

AD8231-EP

Parameter	Conditions	Min	Typ	Max	Unit
Dynamic Performance					
Bandwidth					
G = 1			2.7		MHz
G = 2			2.5		MHz
Gain Bandwidth Product					
G = 4 to 128			7		MHz
Slew Rate			1.1		V/μs
Output Characteristics					
Output Voltage High	$R_L = 100\text{ k}\Omega$ to ground	2.9	2.94		V
	$R_L = 10\text{ k}\Omega$ to ground	2.8	2.88		V
Output Voltage Low	$R_L = 100\text{ k}\Omega$ to 3 V		60	100	mV
	$R_L = 10\text{ k}\Omega$ to 3 V		80	200	mV
Short-Circuit Current			40		mA
Digital Interface					
Input Voltage Low	$T_A = -55^\circ\text{C}$ to $+125^\circ\text{C}$			0.7	V
Input Voltage High	$T_A = -55^\circ\text{C}$ to $+125^\circ\text{C}$	2.3			V
Setup Time to $\overline{\text{CS}}$ High	$T_A = -55^\circ\text{C}$ to $+125^\circ\text{C}$	60			ns
Hold Time after $\overline{\text{CS}}$ High	$T_A = -55^\circ\text{C}$ to $+125^\circ\text{C}$	20			ns
OPERATIONAL AMPLIFIERS					
Input Characteristics					
Offset Voltage, V_{os}			5	15	μV
Temperature Drift	$T_A = -55^\circ\text{C}$ to $+125^\circ\text{C}$		0.01	0.06	μV/°C
Input Bias Current			250	500	pA
	$T_A = -55^\circ\text{C}$ to $+125^\circ\text{C}$			5	nA
Input Offset Current			20	100	pA
	$T_A = -55^\circ\text{C}$ to $+125^\circ\text{C}$			0.5	nA
Input Voltage Range		0.05		2.95	V
Open-Loop Gain		100	120		V/mV
Common-Mode Rejection Ratio		100	120		dB
Power Supply Rejection Ratio		100	110		dB
Voltage Noise Density			27		nV/√Hz
Voltage Noise	$f = 0.1\text{ Hz}$ to 10 Hz		0.6		μV p-p
Dynamic Performance					
Gain Bandwidth Product			1		MHz
Slew Rate			0.5		V/μs
Output Characteristics					
Output Voltage High	$R_L = 100\text{ k}\Omega$ to ground	2.9	2.96		V
	$R_L = 10\text{ k}\Omega$ to ground	2.8	2.82		V
Output Voltage Low	$R_L = 100\text{ k}\Omega$ to 3 V		60	100	mV
	$R_L = 10\text{ k}\Omega$ to 3 V		80	200	mV
Short-Circuit Current			40		mA
BOTH AMPLIFIERS					
Power Supply					
Quiescent Current			3.5	4.5	mA
Quiescent Current (Shutdown)			0.01	1	μA

ABSOLUTE MAXIMUM RATINGS

Table 4.

Parameter	Rating
Supply Voltage	6 V
Output Short-Circuit Current	Indefinite ¹
Input Voltage (Common-Mode)	$-V_S - 0.3 \text{ V}$ to $+V_S + 0.3 \text{ V}$
Differential Input Voltage	$-V_S - 0.3 \text{ V}$ to $+V_S + 0.3 \text{ V}$
Storage Temperature Range	-65°C to $+150^\circ\text{C}$
Operational Temperature Range	-55°C to $+125^\circ\text{C}$
Package Glass Transition Temperature	130°C
ESD (Human Body Model)	1.5 kV
ESD (Charged Device Model)	1.5 kV
ESD (Machine Model)	0.2 kV

¹ For junction temperatures between 105°C and 130°C, short-circuit operation beyond 1000 hours can impact part reliability.

Stresses above those listed under Absolute Maximum Ratings may cause permanent damage to the device. This is a stress rating only; functional operation of the device at these or any other conditions above those indicated in the operational section of this specification is not implied. Exposure to absolute maximum rating conditions for extended periods may affect device reliability.

THERMAL RESISTANCE

Table 5.

Thermal Pad	θ_{JA}	Unit
Soldered to Board	54	$^\circ\text{C}/\text{W}$
Not Soldered to Board	96	$^\circ\text{C}/\text{W}$

The θ_{JA} values in Table 5 assume a 4-layer JEDEC standard board. If the thermal pad is soldered to the board, it is also assumed it is connected to a plane. θ_{JC} at the exposed pad is $6.3^\circ\text{C}/\text{W}$.

MAXIMUM POWER DISSIPATION

The maximum safe power dissipation for the AD8231-EP is limited by the associated rise in junction temperature (T_j) on the die. At approximately 130°C, which is the glass transition temperature, the plastic changes its properties. Even temporarily exceeding this temperature limit may change the stresses that the package exerts on the die, permanently shifting the parametric performance of the amplifiers. Exceeding a temperature of 130°C for an extended period can result in a loss of functionality.

ESD CAUTION



ESD (electrostatic discharge) sensitive device. Charged devices and circuit boards can discharge without detection. Although this product features patented or proprietary protection circuitry, damage may occur on devices subjected to high energy ESD. Therefore, proper ESD precautions should be taken to avoid performance degradation or loss of functionality.

PIN CONFIGURATION AND FUNCTION DESCRIPTIONS

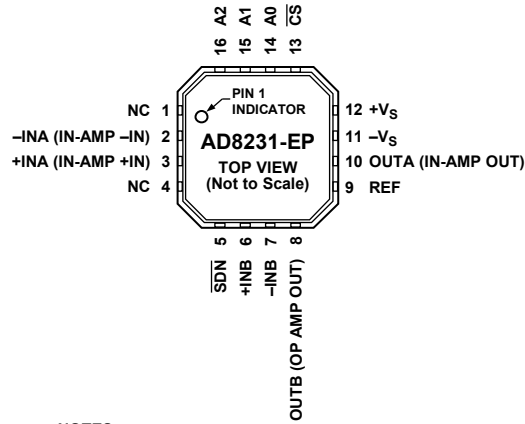

NOTES
 1. NC = NO CONNECT. DO NOT CONNECT TO THIS PIN.
 2. THE EXPOSED PAD CAN BE CONNECTED TO THE NEGATIVE SUPPLY ($-V_S$) OR LEFT FLOATING.

09707-002

Figure 2. Pin Configuration

Table 6. Pin Function Descriptions

Pin Number	Mnemonic	Description
1	NC	No Connect. Do not connect to this pin.
2	-INA (IN-AMP -IN)	Instrumentation Amplifier Negative Input.
3	+INA (IN-AMP +IN)	Instrumentation Amplifier Positive Input.
4	NC	No Connect. Do not connect to this pin.
5	\overline{SDN}	Shutdown.
6	+INB	Operational Amplifier Positive Input.
7	-INB	Operational Amplifier Negative Input.
8	OUTB (OP AMP OUT)	Operational Amplifier Output.
9	REF	Instrumentation Amplifier Reference Pin. It should be driven with a low impedance. Output is referred to this pin.
10	OUTA (IN-AMP OUT)	Instrumentation Amplifier Output.
11	$-V_S$	Negative Power Supply. Connect to ground in single-supply applications.
12	$+V_S$	Positive Power Supply.
13	\overline{CS}	Chip Select. Enables digital logic interface.
14	A0	Gain Setting Bit (LSB).
15	A1	Gain Setting Bit.
16	A2	Gain Setting Bit (MSB).
	EPAD	Exposed Pad. Can be connected to the negative supply ($-V_S$) or left floating.

TYPICAL PERFORMANCE CHARACTERISTICS

INSTRUMENTATION AMPLIFIER PERFORMANCE CURVES

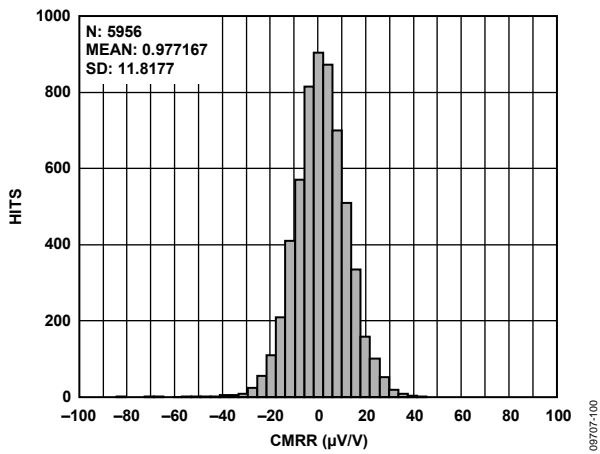

Figure 3. Instrumentation Amplifier CMR Distribution, $G = 1$

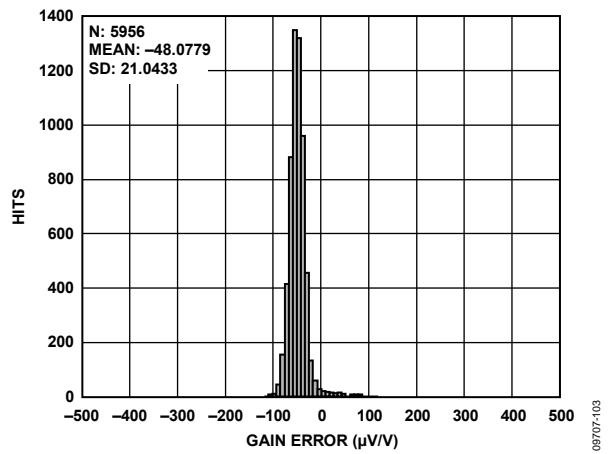

Figure 6. Instrumentation Amplifier Gain Distribution, $G = 1$

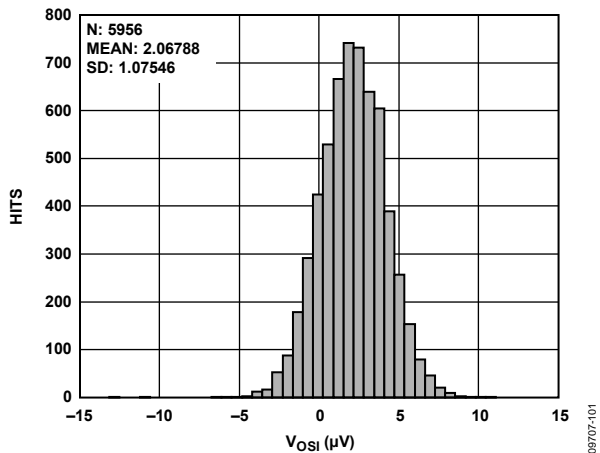

Figure 4. Instrumentation Amplifier Input Offset Voltage Distribution

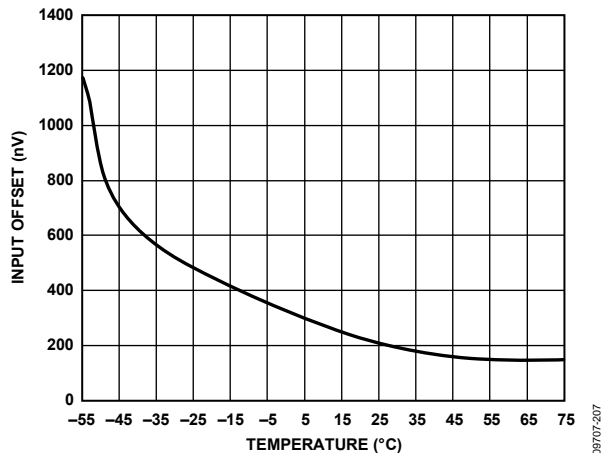

Figure 7. Instrumentation Amplifier Input Offset Voltage Drift, -55°C to $+125^{\circ}\text{C}$

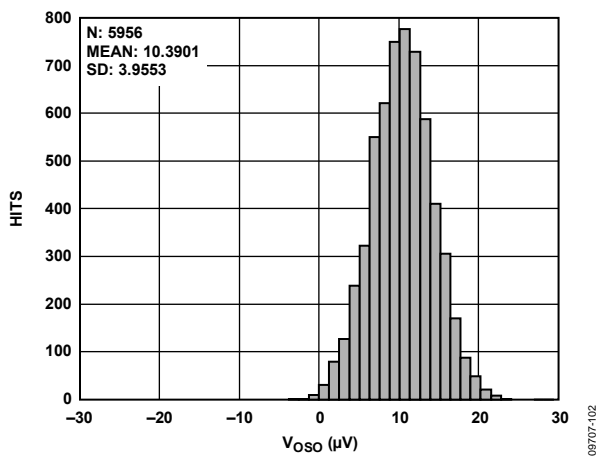

Figure 5. Instrumentation Amplifier Output Offset Voltage Distribution

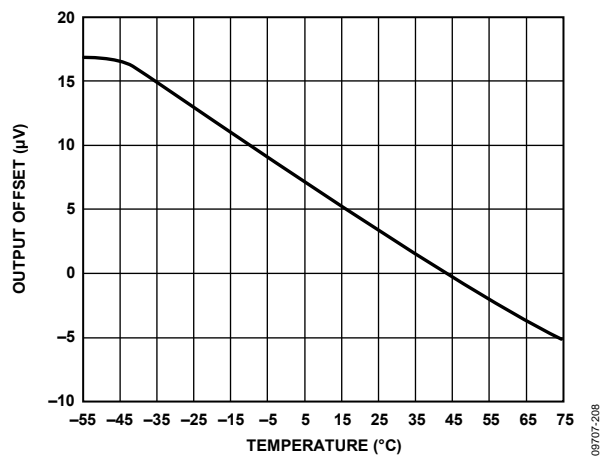

Figure 8. Instrumentation Amplifier Output Offset Drift, -55°C to $+125^{\circ}\text{C}$

AD8231-EP

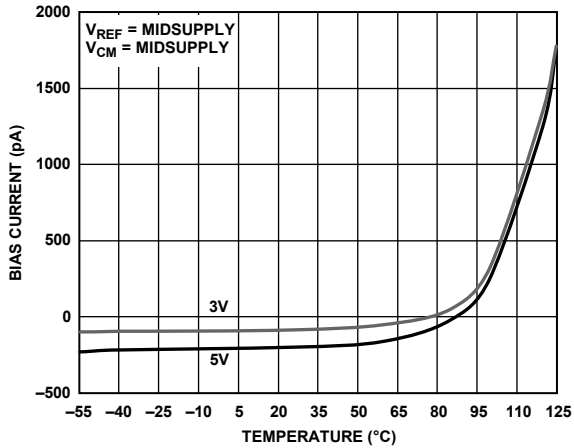

Figure 9. Instrumentation Amplifier Bias Current vs. Temperature

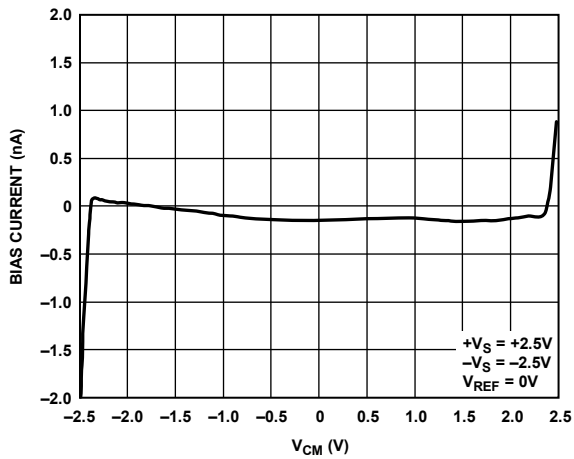

Figure 10. Instrumentation Amplifier Bias Current vs. Common-Mode Voltage, 5V

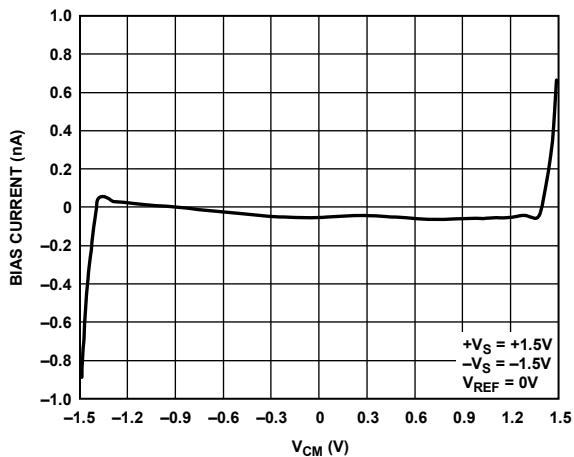

Figure 11. Instrumentation Amplifier Bias Current vs. Common-Mode Voltage, 3V

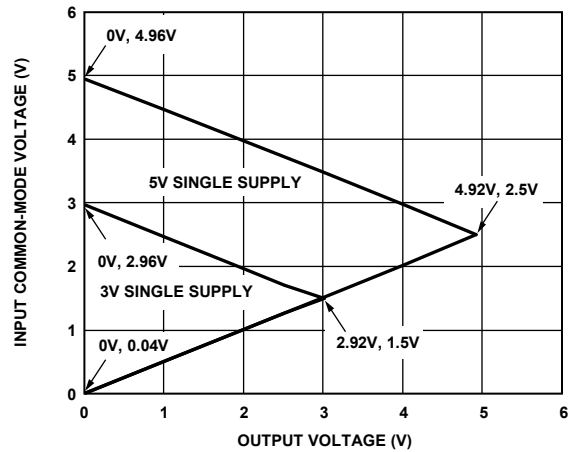

Figure 12. Instrumentation Amplifier Input Common-Mode Range vs. Output Voltage, $V_{REF} = 0V$

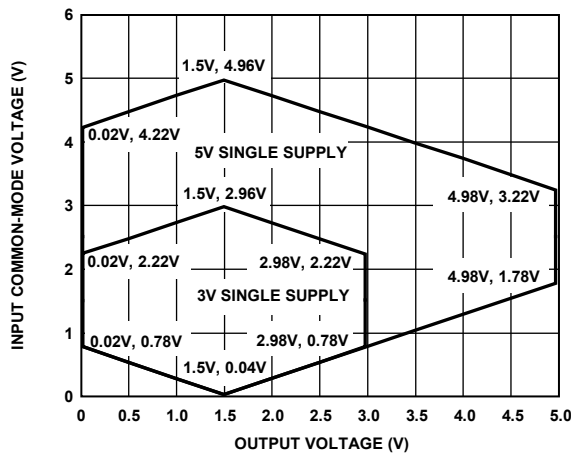

Figure 13. Instrumentation Amplifier Input Common-Mode Range vs. Output Voltage, $V_{REF} = 1.5V$

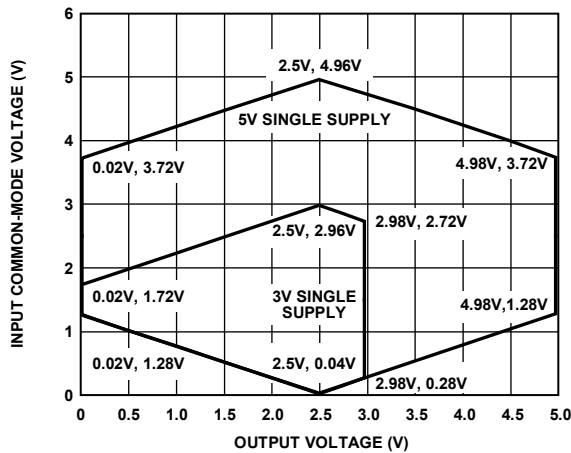

Figure 14. Instrumentation Amplifier Input Common-Mode Range vs. Output Voltage, $V_{REF} = 2.5V$

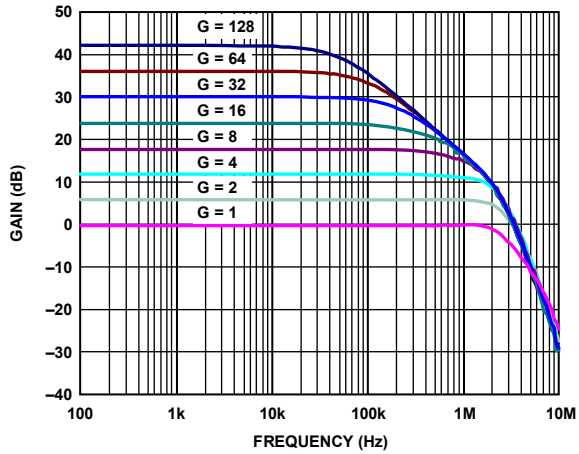

Figure 15. Instrumentation Amplifier Gain vs. Frequency

09707-009

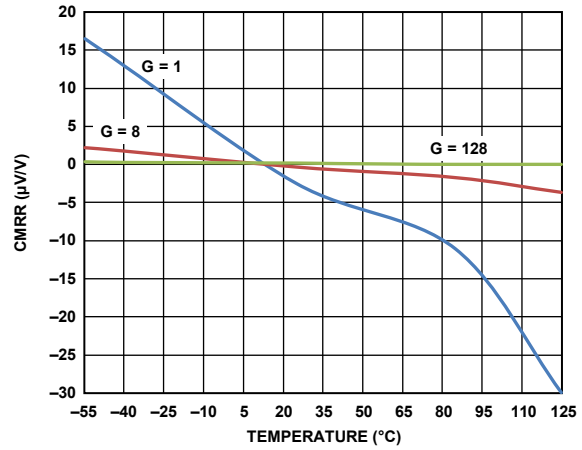

Figure 18. Instrumentation Amplifier CMRR vs. Temperature

09707-218

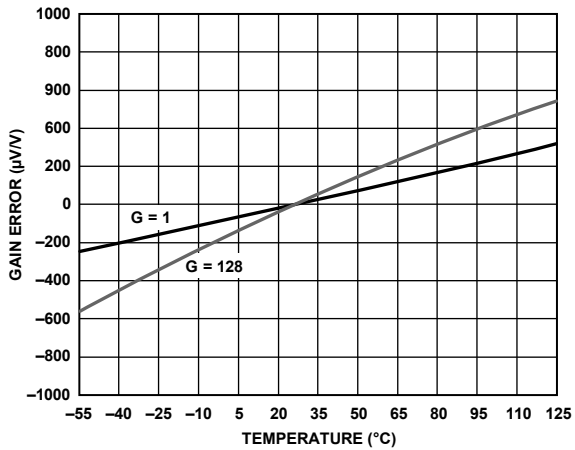

Figure 16. Instrumentation Amplifier Gain Drift vs. Temperature

09707-216

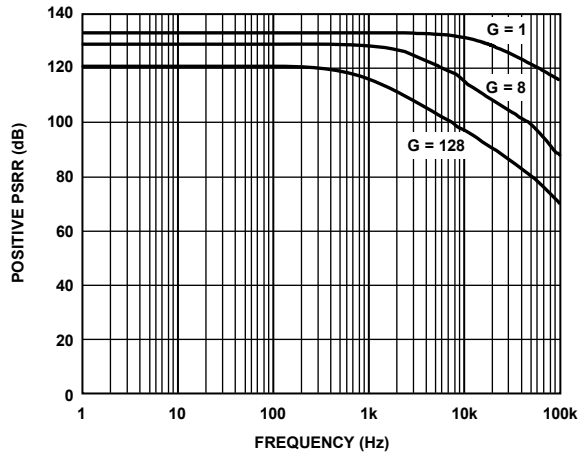

Figure 19. Instrumentation Amplifier Positive PSRR vs. Frequency

09707-146

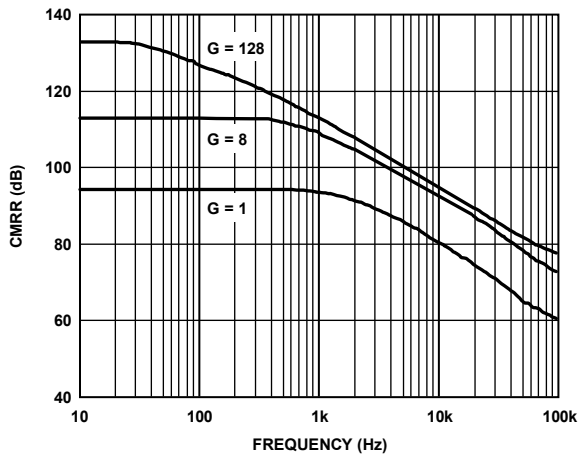

Figure 17. Instrumentation Amplifier CMRR vs. Frequency

09707-010

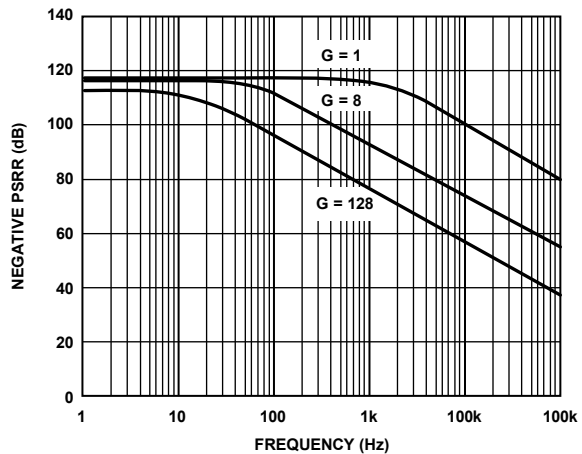

Figure 20. Instrumentation Amplifier Negative PSRR vs. Frequency

09707-147

AD8231-EP

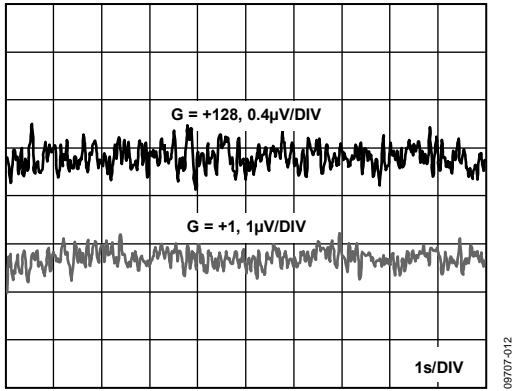

Figure 21. Instrumentation Amplifier 0.1 Hz to 10 Hz Noise

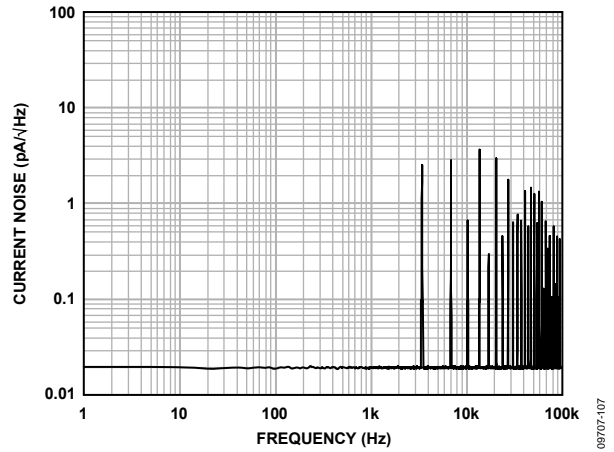

Figure 24. Instrumentation Amplifier Current Noise Spectral Density

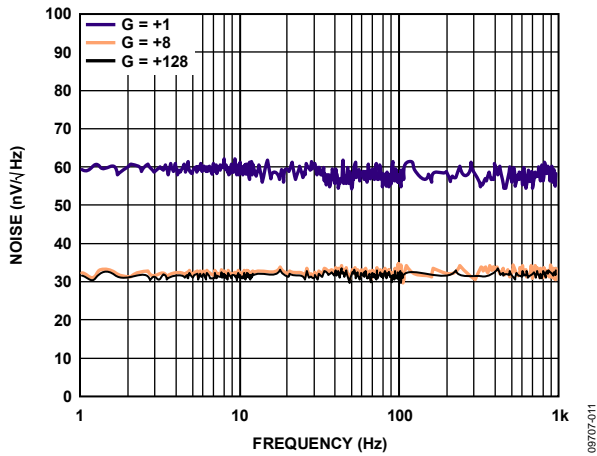

Figure 22. Instrumentation Amplifier Voltage Noise Spectral Density vs. Frequency, 5 V, 1 Hz to 1000 Hz

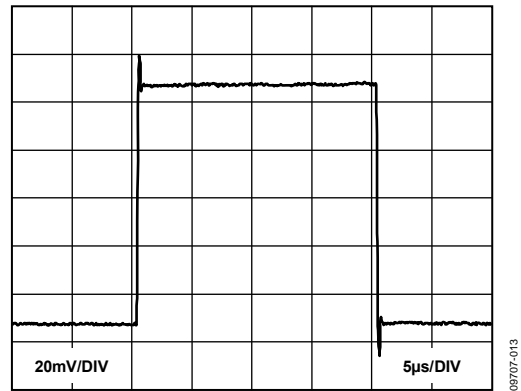

Figure 25. Instrumentation Amplifier Small Signal Pulse Response, $G = 1$, $R_L = 2 \text{ k}\Omega$, $C_L = 500 \text{ pF}$

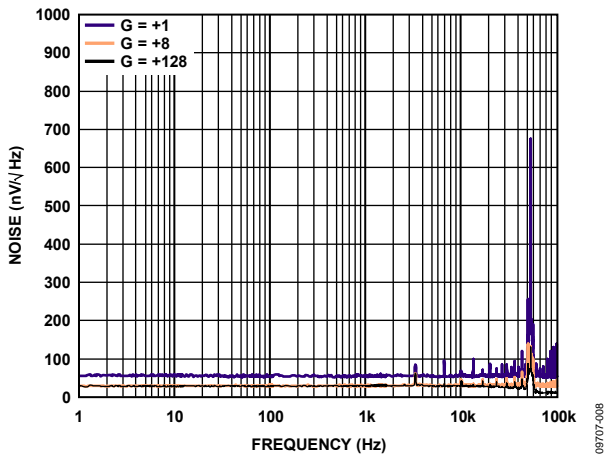

Figure 23. Instrumentation Amplifier Voltage Noise Spectral Density vs. Frequency, 5 V, 1 Hz to 1 MHz

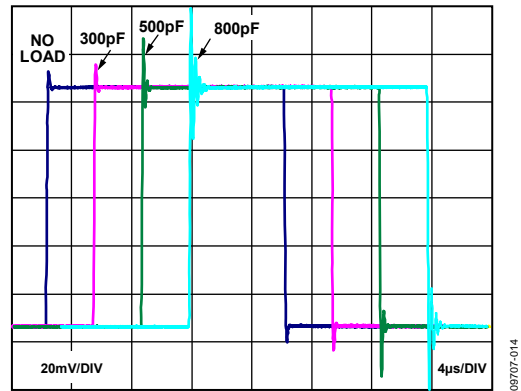

Figure 26. Instrumentation Amplifier Small Signal Pulse Response for Various Capacitive Loads, $G = 1$

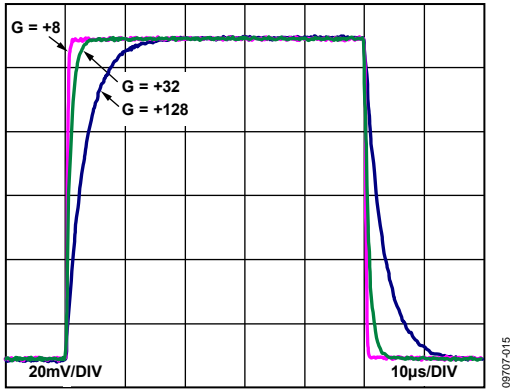

Figure 27. Instrumentation Amplifier Small Signal Pulse Response, $G = 4, 16,$ and $128, R_L = 2\text{ k}\Omega, C_L = 500\text{ pF}$

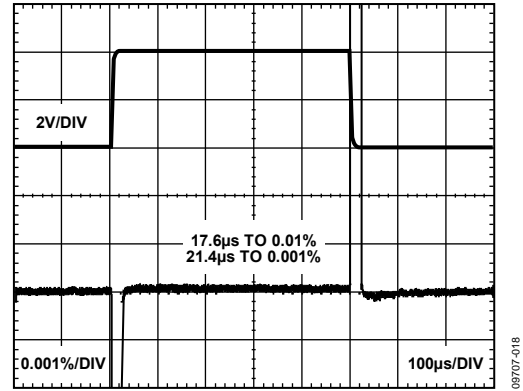

Figure 30. Instrumentation Amplifier Large Signal Pulse Response, $G = 128, V_S = 5\text{ V}$

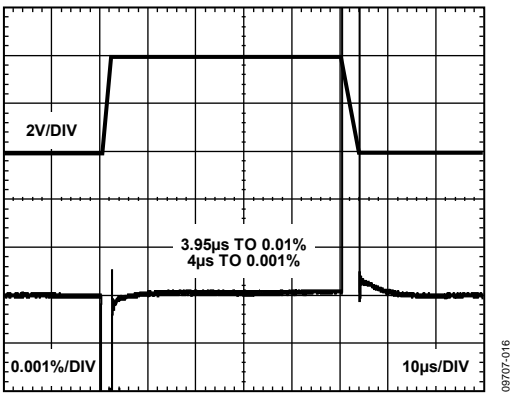

Figure 28. Instrumentation Amplifier Large Signal Pulse Response, $G = 1, V_S = 5\text{ V}$

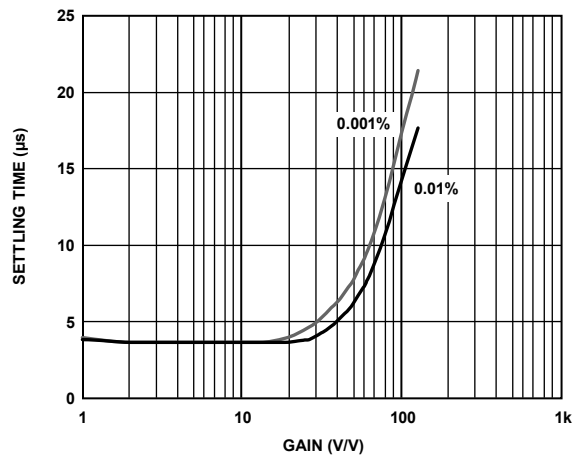

Figure 31. Instrumentation Amplifier Settling Time vs. Gain for a $4\text{ V p-p Step}, V_S = 5\text{ V}$

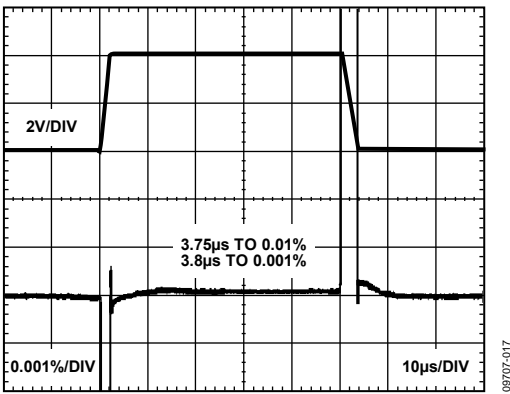

Figure 29. Instrumentation Amplifier Large Signal Pulse Response, $G = 8, V_S = 5\text{ V}$

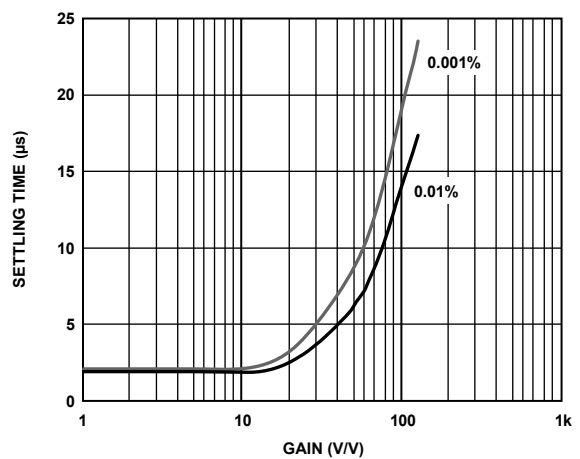

Figure 32. Instrumentation Amplifier Settling Time vs. Gain for a $2\text{ V p-p Step}, V_S = 3\text{ V}$

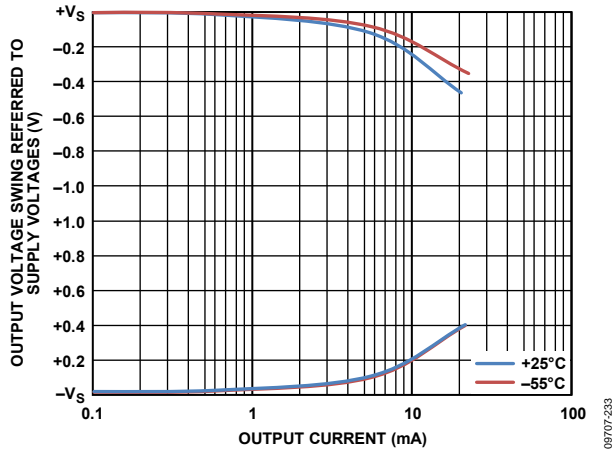

Figure 33. Instrumentation Amplifier Output Voltage Swing vs. Output Current, $V_S = 3V$

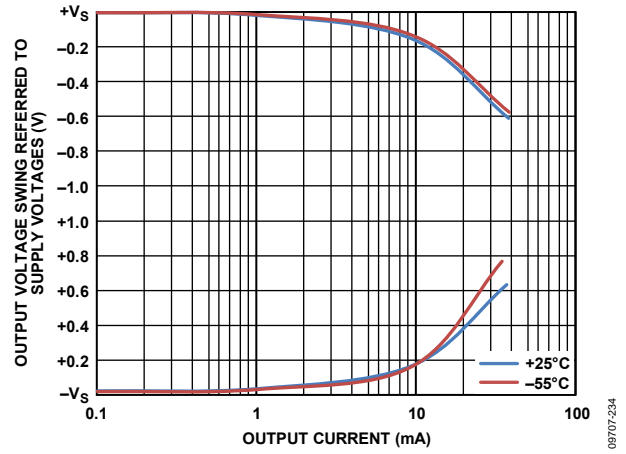

Figure 34. Instrumentation Amplifier Output Voltage Swing vs. Output Current, $V_S = 5V$

OPERATIONAL AMPLIFIER PERFORMANCE CURVES

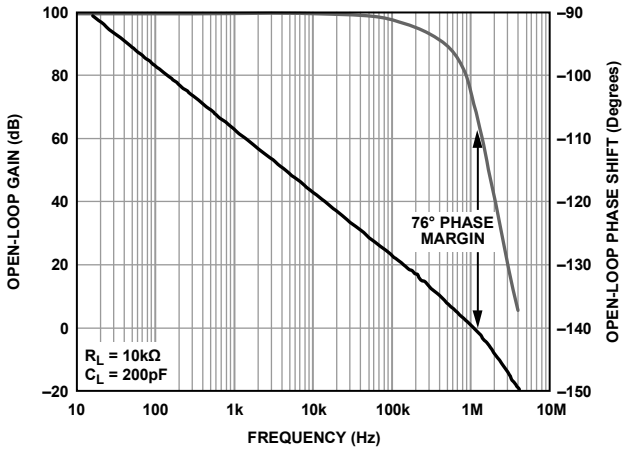

Figure 35. Operational Amplifier Open-Loop Gain and Phase vs. Frequency, $V_S = 5\text{ V}$

09707-021

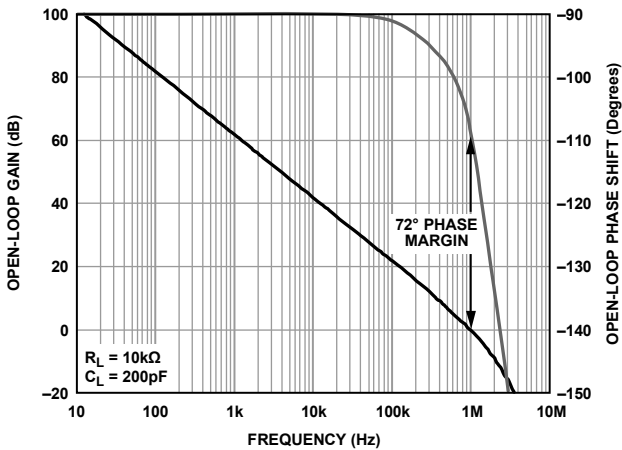

Figure 36. Operational Amplifier Open-Loop Gain and Phase vs. Frequency, $V_S = 3\text{ V}$

09707-022

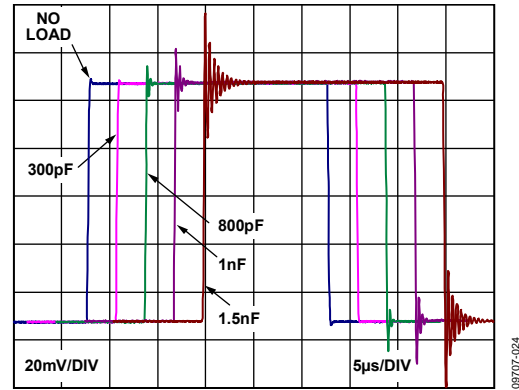

Figure 38. Operational Amplifier Small Signal Response for Various Capacitive Loads, $V_S = 3\text{ V}$

09707-024

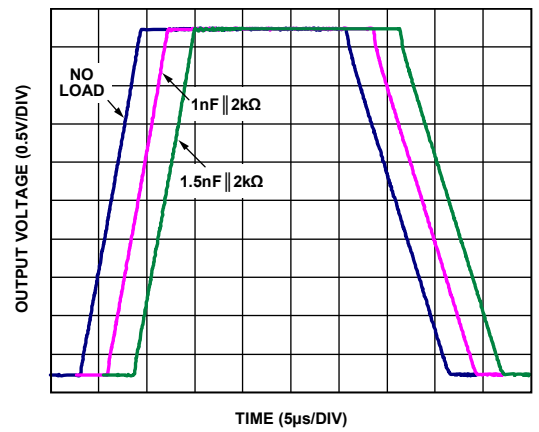

Figure 39. Operational Amplifier Large Signal Transient Response, $V_S = 5\text{ V}$

09707-025

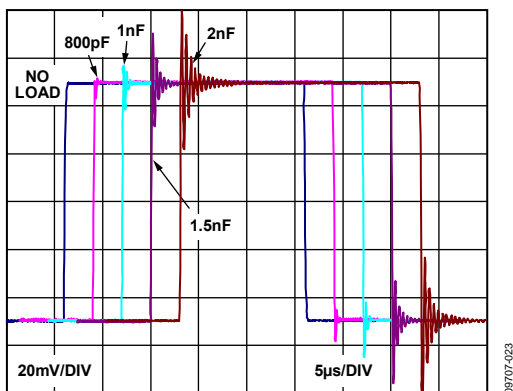

Figure 37. Operational Amplifier Small Signal Response for Various Capacitive Loads, $V_S = 5\text{ V}$

09707-023

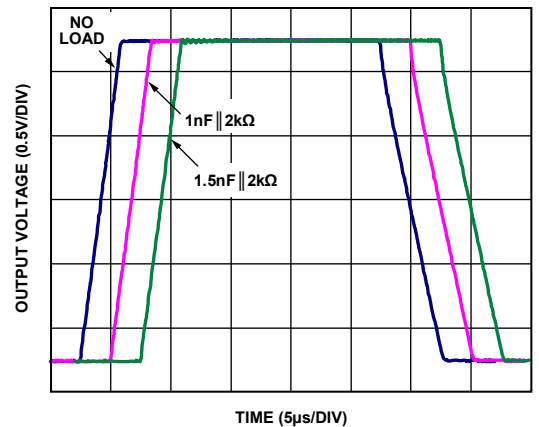

Figure 40. Operational Amplifier Large Signal Transient Response, $V_S = 3\text{ V}$

09707-026

AD8231-EP

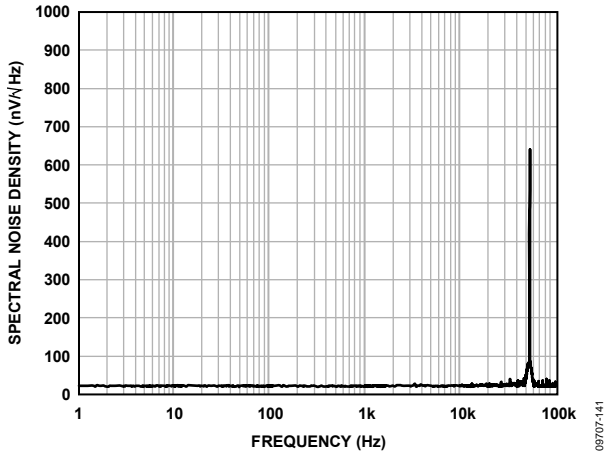

Figure 41. Operational Amplifier Voltage Spectral Noise Density vs. Frequency

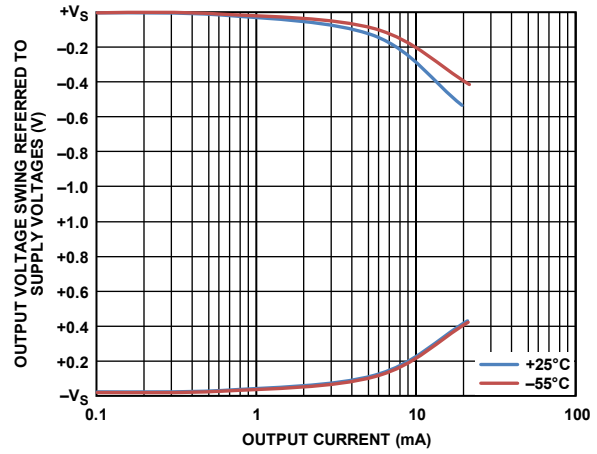

Figure 44. Operational Amplifier Output Voltage Swing vs. Output Current, $V_S = 3\text{ V}$

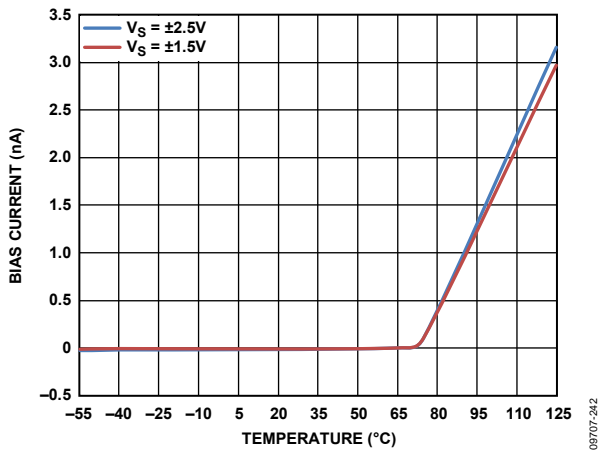

Figure 42. Operational Amplifier Bias Current vs. Temperature

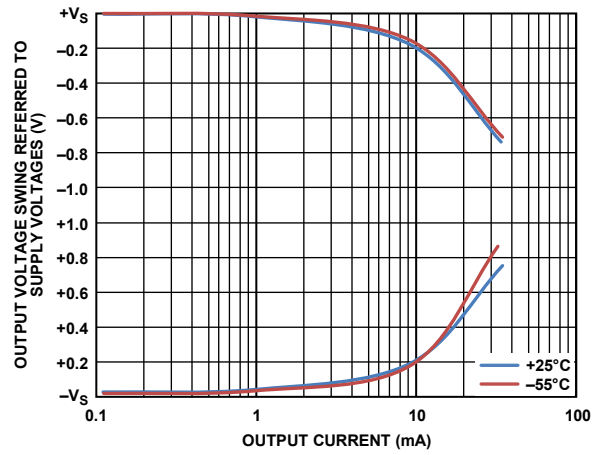

Figure 45. Operational Amplifier Output Voltage Swing vs. Output Current, $V_S = 5\text{ V}$

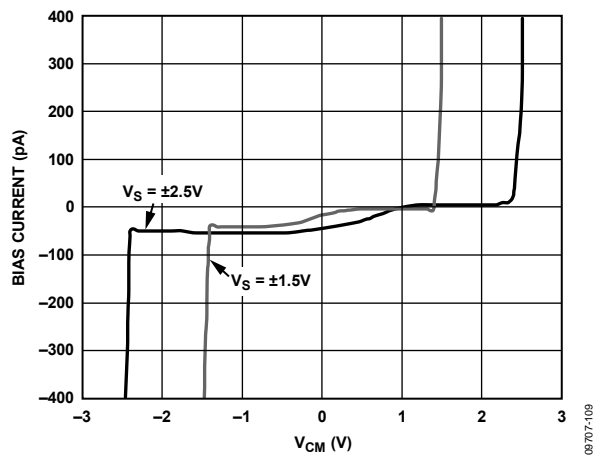

Figure 43. Operational Amplifier Bias Current vs. Common Mode

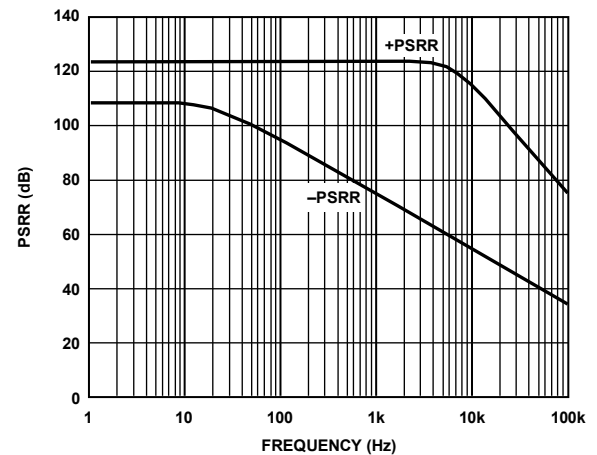

Figure 46. Operational Amplifier Power Supply Rejection Ratio

PERFORMANCE CURVES VALID FOR BOTH AMPLIFIERS

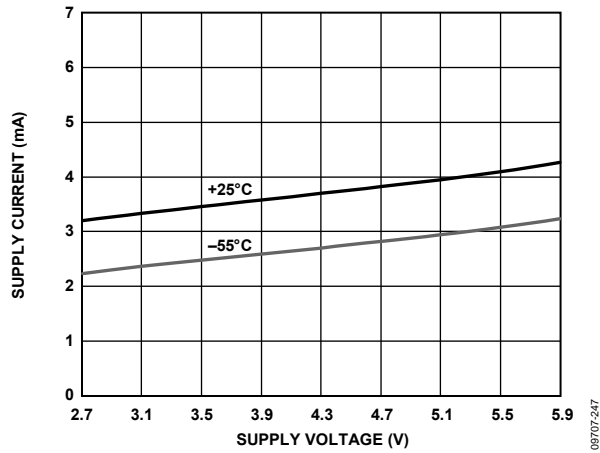

Figure 47. Supply Current vs. Supply Voltage

08707-2-47

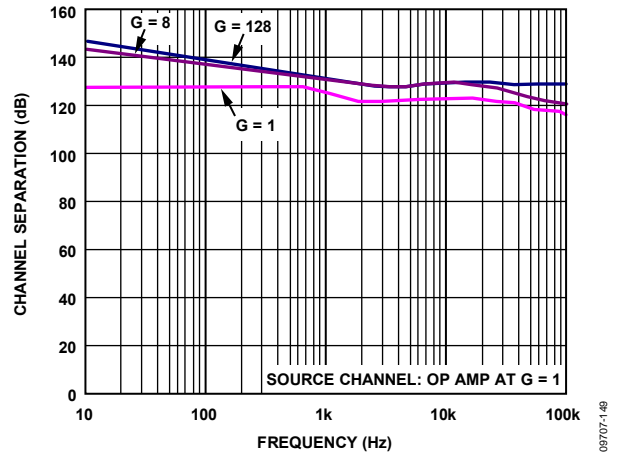
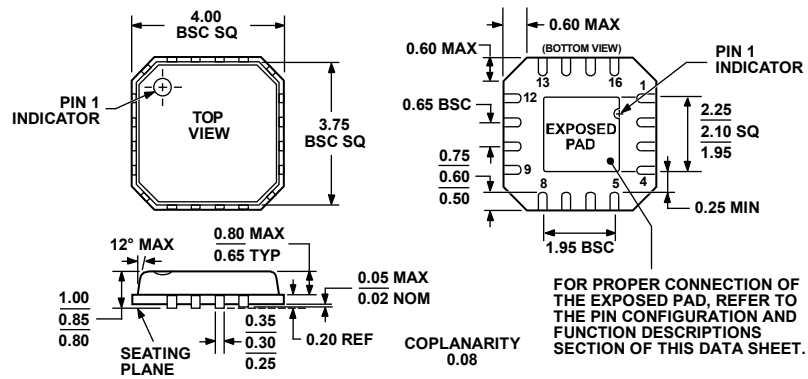

Figure 48. Channel Separation vs. Frequency

08707-1-48

AD8231-EP

OUTLINE DIMENSIONS



COMPLIANT TO JEDEC STANDARDS MO-220-VGGC

Figure 49. 16-Lead Lead Frame Chip Scale Package [LFCSP_VQ]
4 mm × 4 mm Body, Very Thin Quad
(CP-16-4)

Dimensions shown in millimeters

072808-A

ORDERING GUIDE

Model ¹	Temperature Range	Package Description	Package Option
AD8231TCPZ-EP-R7	-55°C to +125°C	16-Lead LFCSP_VQ, 7" Tape and Reel	CP-16-4

¹ Z = RoHS Compliant Part.

NOTES

AD8231-EP

NOTES