

LPCXpresso Base Board rev B - User's Guide

Copyright 2013 © Embedded Artists AB

LPCXpresso Base Board Rev B User's Guide

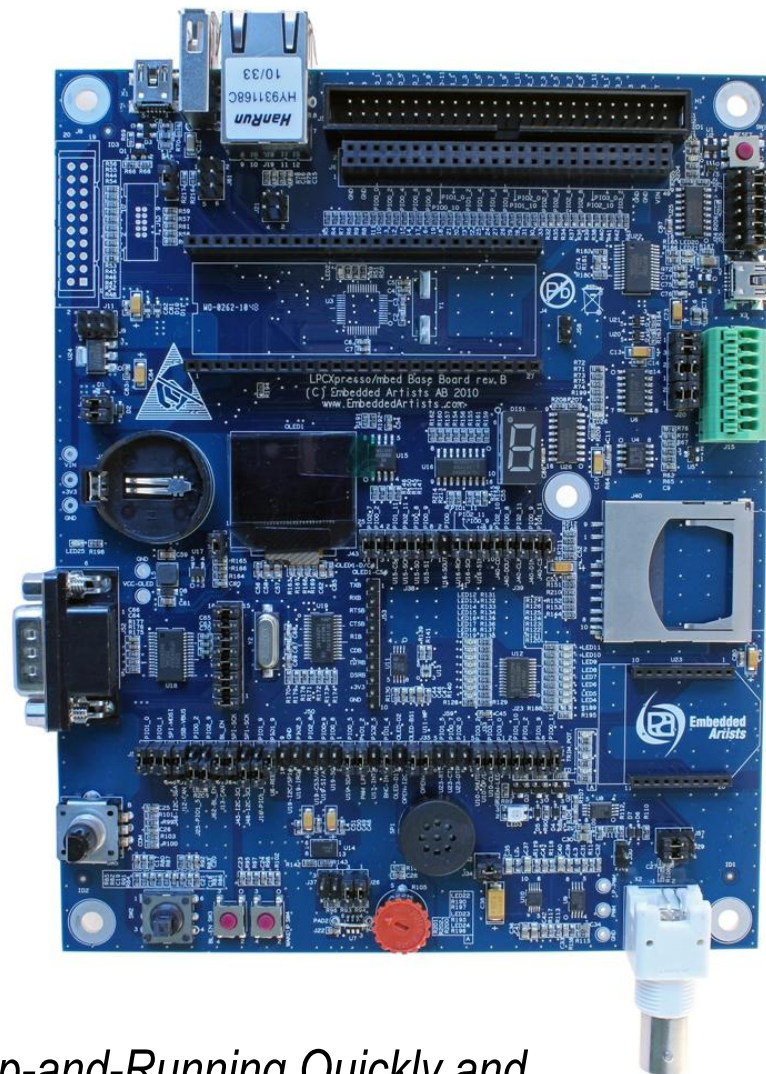

*Get Up-and-Running Quickly and
Start Developing Your Applications On Day 1!*

Embedded Artists AB

Davidshallsgatan 16
SE-211 45 Malmö
Sweden

info@EmbeddedArtists.com
<http://www.EmbeddedArtists.com>

Copyright 2013 © Embedded Artists AB. All rights reserved.

No part of this publication may be reproduced, transmitted, transcribed, stored in a retrieval system, or translated into any language or computer language, in any form or by any means, electronic, mechanical, magnetic, optical, chemical, manual or otherwise, without the prior written permission of Embedded Artists AB.

Disclaimer

Embedded Artists AB makes no representation or warranties with respect to the contents hereof and specifically disclaim any implied warranties or merchantability or fitness for any particular purpose. Information in this publication is subject to change without notice and does not represent a commitment on the part of Embedded Artists AB.

Feedback

We appreciate any feedback you may have for improvements on this document. Please send your comments to support@EmbeddedArtists.com.

Trademarks

All brand and product names mentioned herein are trademarks, services marks, registered trademarks, or registered service marks of their respective owners and should be treated as such.

Table of Contents

1	Document Revision History	5
2	Introduction	6
2.1	Features	6
2.2	ESD and Handling Precaution	7
2.3	CE Assessment	7
2.4	Other Products from Embedded Artists	7
2.4.1	Design and Production Services	8
2.4.2	OEM / Education / QuickStart Boards and Developer's Kits	8
3	Getting Started	9
3.1	LPCXpresso	9
3.2	Initial Preparation	9
3.3	Board Powering	10
3.4	Console Interface via USB-to-UART Bridge	11
3.4.1	FTDI USB Driver	11
3.4.2	USB Driver Behavior	14
3.5	Main Components	15
3.6	Default Jumper Positions	16
3.6.1	Illegal Jumper Combinations	16
3.7	Import Sample Applications	17
3.8	Demo Application	20
3.9	Program Download	21
3.9.1	Using LPCXpresso IDE/Debugger	21
3.9.2	Using USB Boot Mode (LPC1343)	21
3.9.3	Using UART (ISP) Boot Mode for LPC1343 / 1227 / 11C24 / 11U14 / 1114	25
3.9.4	Using UART (ISP) Boot Mode for LPC176x	26
4	Peripherals and Jumper Settings	27
4.1	UART	27
4.1.1	USB-to-UART Bridge – U22	27
4.1.2	RS422/485 – U6	29
4.1.3	RF-module – U23	32
4.2	I2C	33
4.2.1	E2PROM, 24LC08 – U11	33
4.2.2	Port Expander, PCA9532 – U12	33
4.2.3	Light Sensor, ISL29003 – U13	34
4.2.4	Accelerometer, MMA7455 – U14	34
4.3	SPI	35
4.3.1	Dataflash, AT45DB016 – U15	36
4.3.2	7-segment display via shift register – U16	37
4.3.3	SD/MMC memory card interface	38
4.4	I2C/SPI	39

4.4.1	OLED Display	39
4.4.2	Dual UART SC16IS752 – U19	40
4.5	USB Device	41
4.6	Direct Digital IO	42
4.6.1	Push Button (BL) – SW3	42
4.6.2	Push Button (WAKEUP) – SW4	42
4.6.3	Quadrature Rotary Switch – SW5	42
4.6.4	Temperature Sensor – U7	43
4.7	PWM IO	43
4.7.1	RGB-LED, LED3	43
4.7.2	PWM Low Pass Filter to Analog Signal, U9	44
4.8	Audio Amplifier	44
4.9	Direct Analog IO	45
4.9.1	Trimming Potentiometer – R105	45
4.9.2	BNC Analog Input, X2 and U8	45
4.10	LPC176x and mbed: USB Host, CAN and Ethernet	47
4.10.1	USB Host – J60/J61	47
4.10.2	CAN – U4	47
4.10.3	Ethernet – J19	48
5	Usage of CPU Pins	49
5.1	Expansion Connectors	50
6	mbed and LPC1xxx Differences	52
6.1	mbed	52
6.2	LPCXpresso LPC11C24	54
6.3	LPCXpresso LPC176x	54
6.3.1	GPIO_21/22 needs pull-up resistors	54
6.3.2	ISP mode UART availability	54
6.3.3	Analog input filtering	54
7	Mechanical Dimensions	55
8	Troubleshooting	56
8.1	The Board is Always in Reset	56
8.2	The Board Behaves Strange	56
8.3	Analog Input GPIO_11 Does Not Reach Zero	56
9	Further Information	57

1 Document Revision History

<i>Revision</i>	<i>Date</i>	<i>Description</i>
PA1-PA2	2010-01-20	First incomplete version.
PA3	2010-01-24	Second, still incomplete version.
PA4	2010-01-25	Added more information about jumper settings.
PA5	2010-01-26	Added information to the Getting Started Chapter.
PA6	2010-01-26	Completed chapter 5 and 6.
PA7	2010-01-28	Completed chapter 4 and updated chapter 6.
PA8	2010-01-29	Updated chapter 3 and added Troubleshooting chapter (8).
PA9	2010-01-30	First complete version.
PA10	2010-02-10	Added information about PIO0_11 analog input.
PA11	2010-02-11	Added information about J54 in section 8.1.
PA12	2010-02-17	Corrected errors in Figure 23 and Figure 35.
PA13	2010-02-20	Added information about SW4 and updated powering instructions.
PA14	2010-02-22	Updated section 3.3: Added a recommendation to use the USB interfaces on the Base Board to power the board.
PA15	2010-03-28	Corrected default jumper settings picture (fig 10). Clarified the board powering information.
PA16	2010-10-21	Added information about rev A and rev B differences. Added information about mbed and LPC176x specific jumper settings.
PA17	2010-11-24	Updated section 3.9 and 3.10.3 regarding LPC176x ISP UART mode. Added section 3.10.4.
PA18	2011-01-19	Made this a separate document for rev B of the LPCXpresso Base Board. There is a separate document for rev A of the board. Clarified that LPC176x ISP mode is not directly supported by the board.
PA19	2011-06-15	Updated to generic pin names on the schematic. Added some LPC176x specific differences.
PA20	2011-06-21	Jumper setting for Fig 37 corrected. Also clarified that J41 (pin1-2) and J58 must not be inserted when using SD/MMC interface.
PA21	2011-08-18	Corrected Fig 35 to be for rev B of the board.
A	2011-08-24	Added section about LPCXpresso LPC11C24 differences.
B	2011-12-19	Added note about CE mark.
PC1	2013-01-25	Added clarifications around LPCXpresso LPC1768/1769 boards.

2 Introduction

Thank you for buying Embedded Artists' *LPCXpresso Base Board*, designed for the *LPCXpresso Board* (with multiple targets LPC176x, LPC134x, LPC1227, LPC11C24, LPC11U14, LPC111x, and more to come) and the *mbed* module from NXP.

This document is a User's Guide that describes the *LPCXpresso Base Board* hardware design. The general focus will be for the *LPCXpresso* boards but differences for the *mbed* module will be noted. All differences between different *LPCXpresso* target boards as well as *mbed* are gathered in a separate chapter; 6 *mbed and LPC1xxx Differences*.

2.1 Features

The *LPCXpresso Base Board* makes it possible for you to get started with experiments and prototyping immediately with the *LPCXpresso Board*. The *LPCXpresso Base Board* can also be used together with the *mbed* module.

The board has been design in cooperation with several Universities in order to also be suitable for training and education situations. The many on-board peripherals easy your learning curve and speed up your program development. The features of the *LPCXpresso Base Board* are:

- | | |
|------------------------------------|--|
| <i>Common features</i> | <ul style="list-style-type: none"> • Socket for <i>LPCXpresso</i> and <i>mbed</i> module • 50 pin expansion dual row pin list connector (male, 100mil pitch) for simple connection external designs and to a logic analyzer • 50 pin expansion dual row header connector (female, 100mil pitch) for simple connection to breadboard • Battery powering (small coin battery) • USB interface • Reset pushbutton |
| <i>Digital IO</i> | <ul style="list-style-type: none"> • RGB-LED (can be PWM controlled) • 5-key joystick switch • 2 pushbuttons, one for activating target mcu on-chip bootloader • Rotary switch with quadrature encoding (timer capture) • Temperature sensor with PWM output (timer capture) |
| <i>Analog IO</i> | <ul style="list-style-type: none"> • Trimming potentiometer input (analog input) • PWM to analog LP-filtering (PWM output and analog input) • Speaker output (PWM output) • Oscilloscope probe inout stage |
| <i>Serial bus - SPI</i> | <ul style="list-style-type: none"> • Shift register driving 7-segment LED • SD/MMC memory card interface • Dataflash SPI-NOR flash |
| <i>Serial bus - I2C</i> | <ul style="list-style-type: none"> • PCA9532 port expander connected to 16 LEDs • 8kbit E2PROM • MMA7455L accelerometer with I2C interface • Light sensor |
| <i>Serial bus - I2C/SPI shared</i> | <ul style="list-style-type: none"> • SC16IS752 - I2C/SPI to 2xUART bridge; connected to RS232 full-modem interface and one expansion UART • 96x64 pixel white OLED (alternative I2C/SPI interface) |
| <i>Serial bus - UART</i> | <ul style="list-style-type: none"> • USB-to-serial bridge, with functionality for automatic ISP activation (note: no such support for LPC176x and <i>mbed</i>) |

	<ul style="list-style-type: none"> • RS422/485 interface • Interface socket for XBee RF-module
<i>Specific mbed module support</i>	<ul style="list-style-type: none"> • CAN bus interface (can be simulated with LPCXpresso) • Ethernet RJ45 connector with integrated magnetic
<i>Dimensions</i>	<ul style="list-style-type: none"> • 150 x 180 mm
<i>Power</i>	<ul style="list-style-type: none"> • Powered via USB (+5V)

2.2 ESD and Handling Precaution

Please note that the *LPCXpresso Base Board* come without any case/box and all components are exposed for finger touches – and therefore extra attention must be paid to ESD (Electro-Static Discharge) precaution.

Make it a habit to always first touch the metal surface of one of the USB or SC/MMC connectors for a few seconds with both hands before touching any other parts of the boards. That way, you will have the same electrical potential as the board and therefore minimize the risk for ESD.

Note that Embedded Artists does not replace boards that have been damaged by ESD.

Do not exercise pressure on the OLED display glass area. That will surely damage the display. Also, do not apply pressure on the flex cable connecting the OLED to the pcb. This cable is relatively sensitive and can be damaged if too much pressure is applied to it.

Note that Embedded Artists do not replace OLED displays where it has been improperly handled.

2.3 CE Assessment

The *LPCXpresso Base Board* (in combination with an LPCXpresso target board) is CE marked. See separate *CE Declaration of Conformity* document.

The *LPCXpresso Base Board* is a class A product. In a domestic environment this product may cause radio interference in which case the user may be required to take adequate measures.

EMC emission test has been performed on the *LPCXpresso Base Board* with the *LPCXpresso LPC1769 Board*. Standard interfaces like Ethernet, USB, serial have been in use. General expansion connectors where internal signals are made available (for example processor pins) have been left unconnected. Connecting other devices to the product via the general expansion connectors may alter EMC emission. It is the user's responsibility to make sure EMC emission limits are not exceeded when connecting other devices to the general expansion connectors of the *LPCXpresso Base Board*.

Due to the nature of the *LPCXpresso Base Board* – an evaluation board not for integration into an end-product – fast transient immunity tests and conducted radio-frequency immunity tests have not been executed. Externally connected cables are assumed to be less than 3 meters. The general expansion connectors where internal signals are made available do not have any other ESD protection than from the chip themselves. Observe ESD precaution.

2.4 Other Products from Embedded Artists

Embedded Artists have a broad range of low cost LPC1000/LPC2000/LPC3000/LPC4000 based boards developed for prototyping / development as well as for OEM applications. Modifications for OEM applications can be done easily, even for modest production volumes. Contact Embedded Artists for further information about design and production services.

2.4.1 Design and Production Services

Embedded Artists provide design services for custom designs, either completely new or modification to existing boards. Specific peripherals and I/O can be added easily to different designs, for example, communication interfaces, specific analog or digital I/O, and power supplies. Embedded Artists has a broad, and long, experience in designing industrial electronics in general and with NXP's LPC1xxx/LPC2xxx/LPC3xxx microcontroller families in specific. Our competence also includes wireless and wired communication for embedded systems. For example IEEE802.11b/g (WLAN), Bluetooth™, ZigBee™, ISM RF, Ethernet, CAN, RS485, and Fieldbuses.

2.4.2 OEM / Education / QuickStart Boards and Developer's Kits

Visit Embedded Artists' home page, www.EmbeddedArtists.com, for information about other *OEM / Education / QuickStart* boards / Developer's kits or contact your local distributor.

3 Getting Started

This chapter contains information about how to get acquainted with the *LPCXpresso Base Board*. **Please read this section first before you start using the board - it will be worthwhile!**

3.1 LPCXpresso

The main source of information about the many different LPCXpresso target boards as well as the LPCXpresso Debugger/IDE is <http://www.nxp.com/lpcxpresso>.

On this site you will find introduction videos, getting started manual, a forum, link to where you can download the IDE and more information that is related to LPCXpresso.

3.2 Initial Preparation

The *LPCXpresso Base Board* is delivered with two pin lists. These pin lists must be soldered onto your LPCXpresso target board before it can be used with the *LPCXpresso Base Board*. Figure 1 and Figure 2 shows how the pin lists are soldered onto an LPCXpresso LPC1343 board. All different LPCXpresso target boards looks very similar and have two (27 pos) edge connectors where the pin lists shall be soldered.

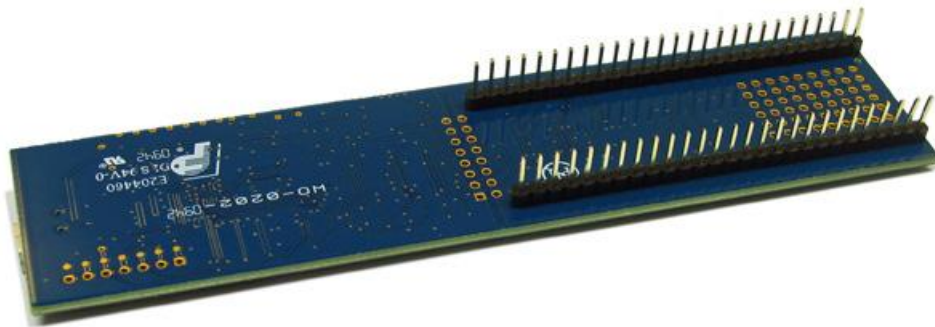

Figure 1 – LPCXpresso LPC1343 target board with pin list, bottom view

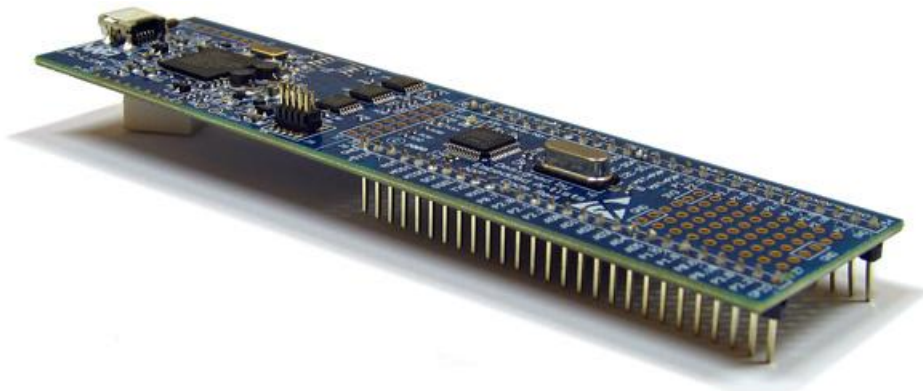

Figure 2 – LPCXpresso LPC1343 target board with pin list, top view

The mbed module already has pin lists, so no special preparation is needed for this module.

3.3 Board Powering

The *LPCXpresso Base Board* shall be powered from a PC via the included USB cable (mini-B to A cable). Up to 500mA can be drawn from the USB port. Note that not all PC USB ports supply the specified top current (500 mA). This is especially true for laptops, but affects many desktop PCs too. If in doubt, use a powered USB hub to power the *LPCXpresso Base Board*.

Symptoms when insufficient power is supplied can exhibit itself in a number of ways:

- the *board is always in reset*; in this case also check section 8.1 for more information. J54 jumpers (see Figure 21) might need to be removed,
- the *board may appear to work*, but:
 - you may fail to program the Flash on the device (as more power is drawn), or
 - the debugger may not be able to find the target, or
 - the debugger may disconnect unexpectedly, or
 - a variety of other inexplicable errors!

There are three USB interfaces in total when the *LPCXpresso target board* is mounted on the *LPCXpresso Base Board*. Technically any of all three can be used to power the system, but the main power source is however the USB-to-UART bridge. See Figure 3. Section 3.4 describes how to install necessary drivers for the USB-to-UART bridge.

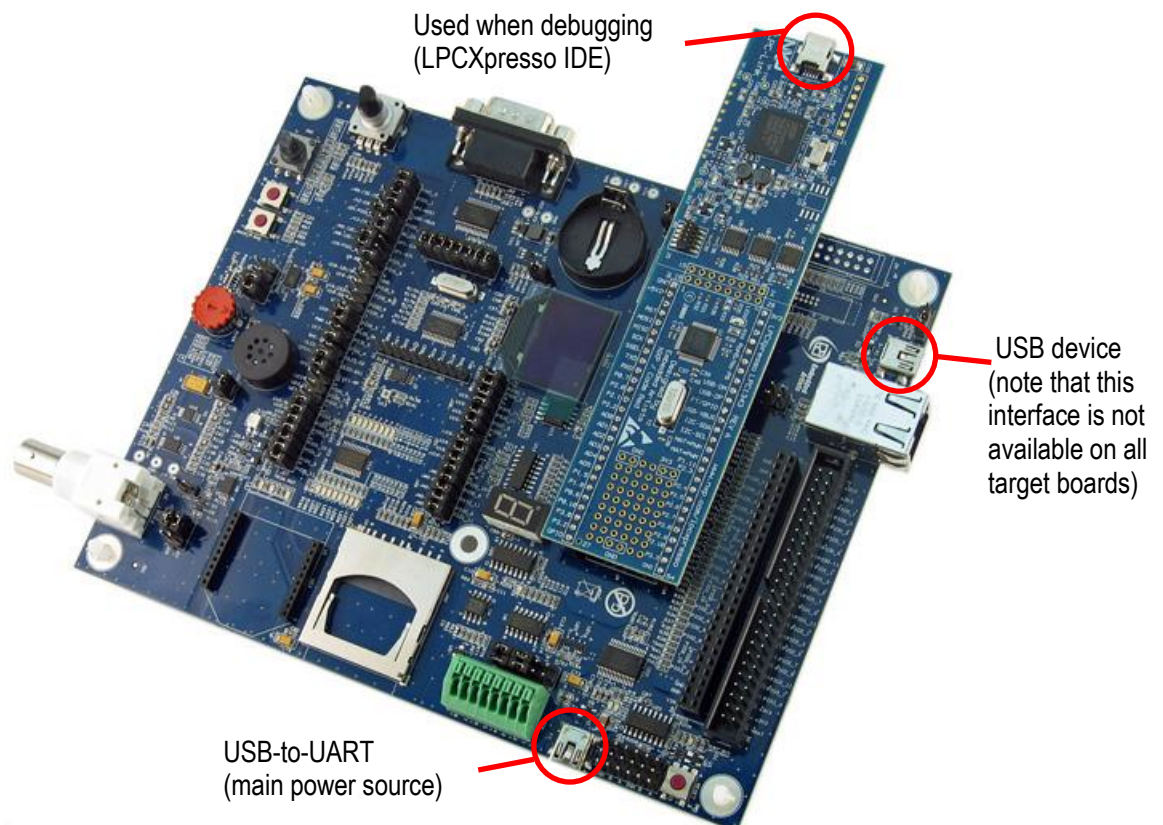

Figure 3 – Base Board with a mounted LPCXpresso LPC1343 board

The *LPCXpresso Base Board* can also be powered via signal VIN (available on expansion connectors). It shall be a regulated +5V DC supply.

3.4 Console Interface via USB-to-UART Bridge

The *LPCXpresso Base Board* contains a USB-to-Serial bridge chip (FT232R from FTDI) that connects one of the UART channels on the *LPCXpresso* target cpu to a virtual COM port on the PC (via USB). It is this serial channel that is the console interface to the system.

Special USB drivers must be installed on the PC in order for the virtual COM port to be created. See subsection below for a description of how to install the FTDI USB driver.

3.4.1 FTDI USB Driver

A USB driver must be installed on your PC computer in order to get the USB-to-UART chip (FT232R) to function. Make sure to download the latest version of the driver, which can be found at the following URL: <http://www.ftdichip.com/Drivers/VCP.htm> (search for a FT232R driver for your operating system).

When the *LPCXpresso Base Board* is connected to the PC (via an USB cable) the PC will ask for a driver. Unpack/unzip the downloaded driver file and browse to the position of the driver files. After successful driver installation, a COM port will be created. Before any communication with the Board can take place the UART settings must be correctly set. The following description is valid for Windows™ XP, but other operating systems have similar dialog windows. See the USB driver documentation for details, if needed.

To change the UART settings, first open the System Properties dialog, as illustrated in the figure below.

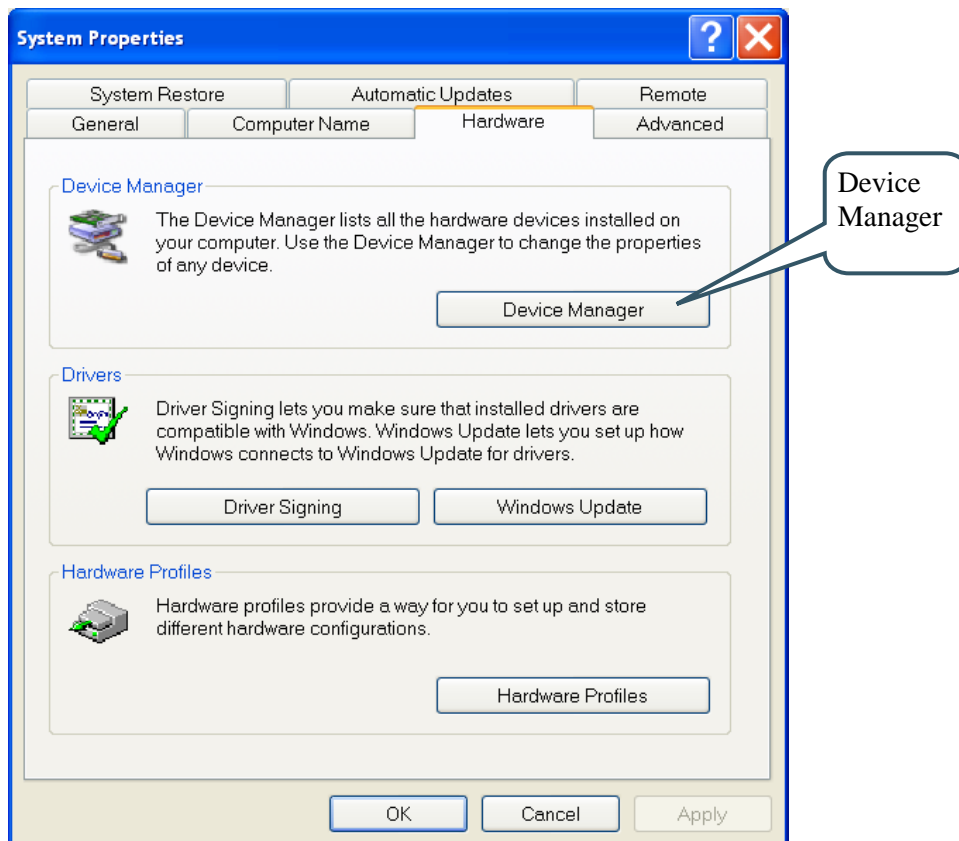

Figure 4 – System Settings Dialog

Then select the *Device Manager* and open the *Ports* list, as illustrated in Figure 5 below.

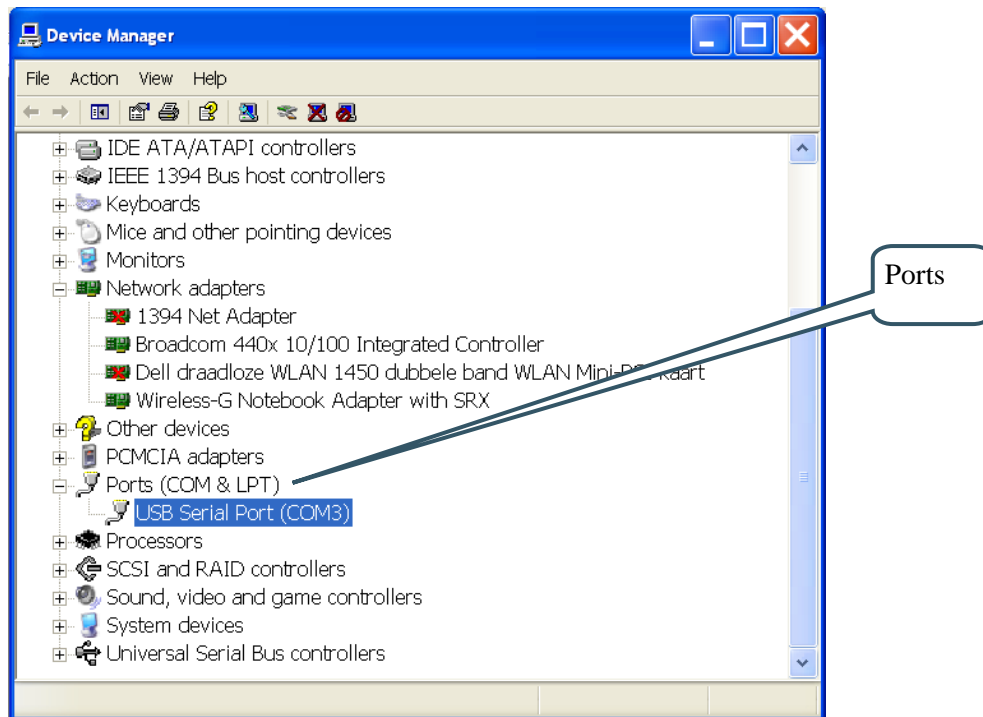

Figure 5 – Device Manager Dialog

The new COM port (USB Serial Port) will be listed under the *Ports* list. Right-click on the new USB Serial Port and select *Properties*, as illustrated in Figure 6 below.

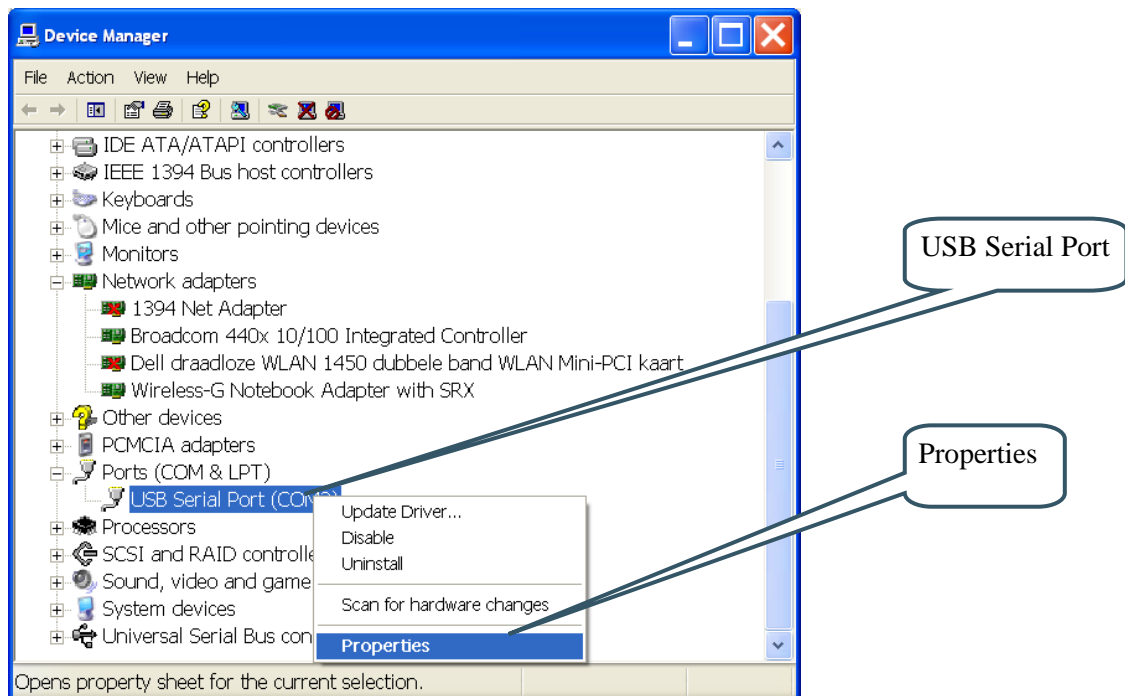

Figure 6 – Device Manager Port Dialog

Select 115200 bits per second, 8 data bits, none parity, 1 stop bit, and none flow control, as illustrated in Figure 7 below. Then select *Advanced* settings. Please note that different application programs can use different baudrate settings for the serial channel. Other baudrates can also be used, depending on your specific application.

Also note that it is normally not needed to set the used baudrate at all. The driver and FT232R chip will automatically handle different baudrates. The setting is only shown here for completeness.

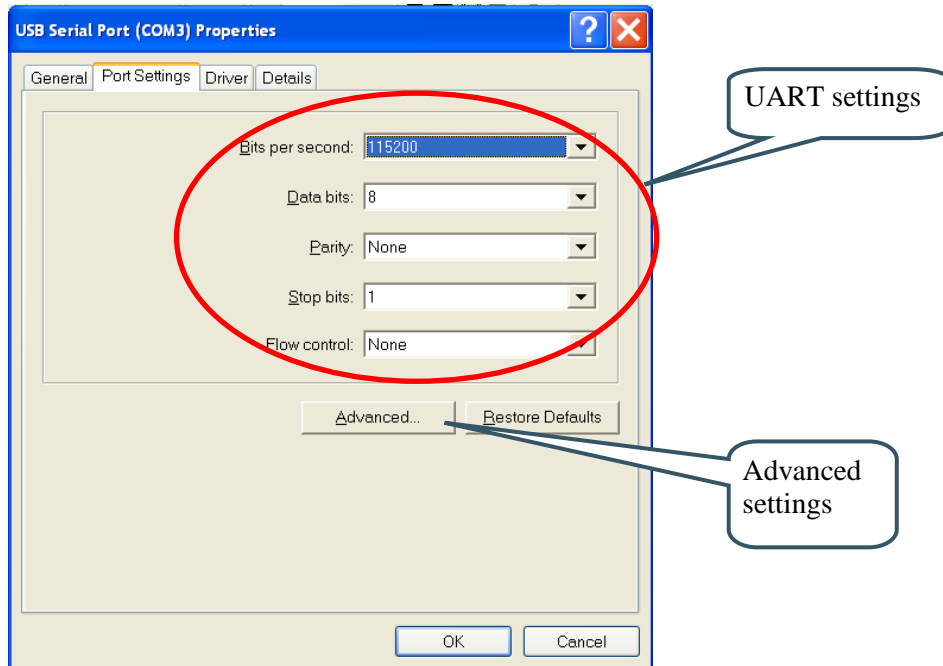

Figure 7 – USB Serial Port Properties Dialog

Select the desired COM port number under the *Advanced* settings dialog. Some terminal programs need low COM port number, for example between 1 and 5. Very often the COM port number for the USB Serial Port is higher than this, therefore this needs to be changed manually.

It is common that all COM ports with low numbers are listed as occupied, but test to change to a low number anyway. Very often it is no problem at all to do so.

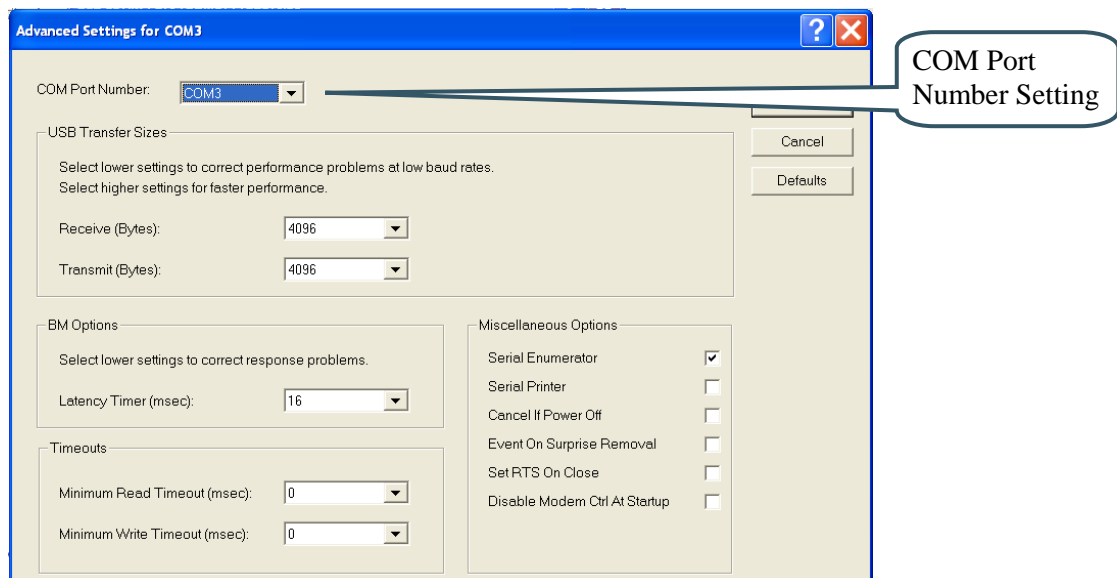

Figure 8 – Advanced USB Serial Port Properties Dialog

Finally it is time to test if you have successfully installed and configured the USB Serial Port. Start a terminal program. Connect to the correct COM port, with 115200 bits per second, 8N1, no flow control.

3.4.2 USB Driver Behavior

Sometimes the USB COM port does not enumerate properly when the board is connected to the PC. This is a known "feature" of the USB driver. If you experience this problem, just unplug the board shortly and then plug it in again. A new COM port that can be accessed properly should be created the second time.

This problem may occur after every time you start (i.e., power cycle) your PC.

3.5 Main Components

Figure 9 below illustrates the main component of the *LPCXpresso Base Board*. The number inside parenthesis (pX) indicate on which schematic page (X) the components can be found.

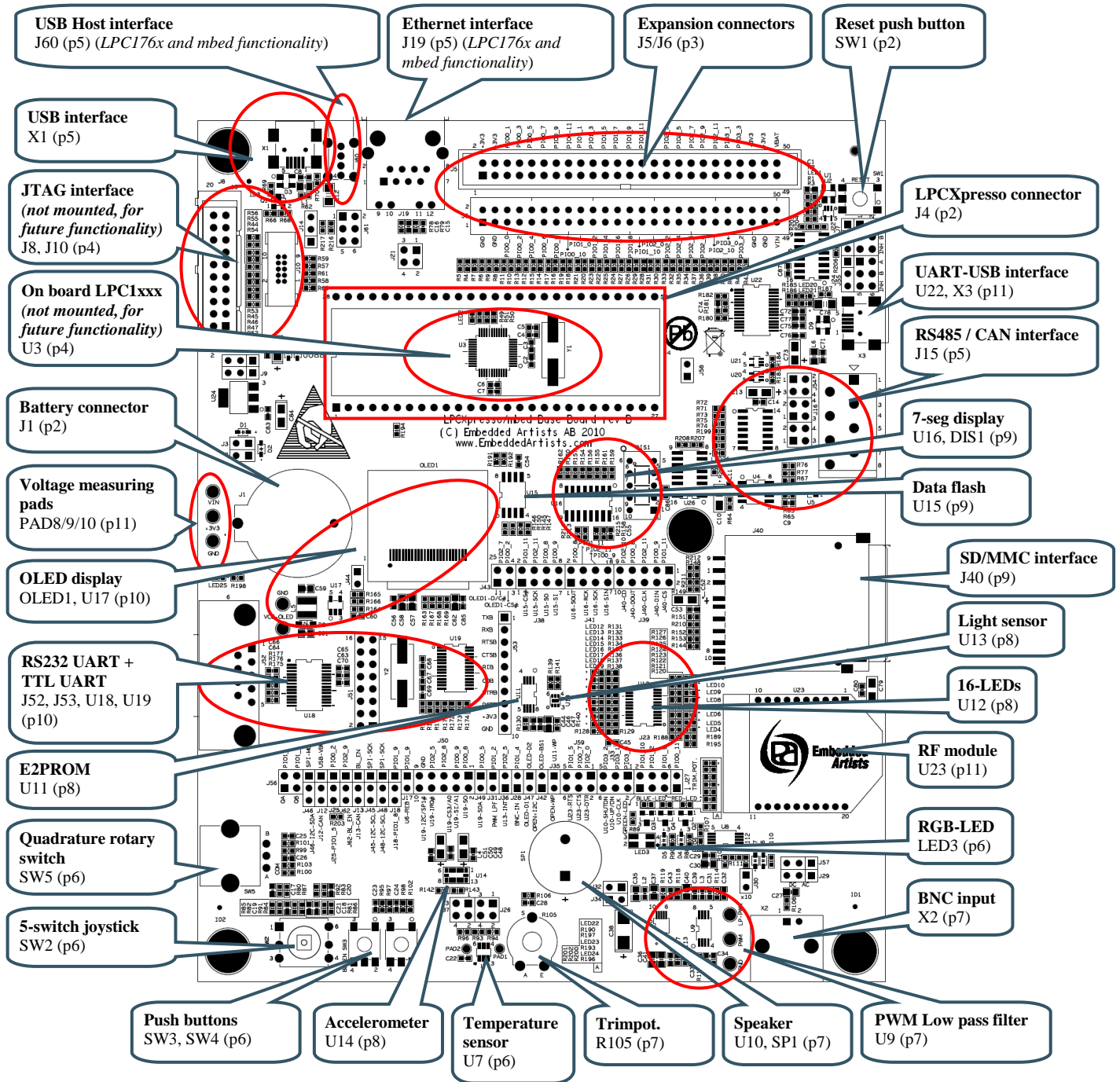

Figure 9 – LPCXpresso Base Board Main Components

3.6 Default Jumper Positions

Figure 10 below illustrates the default jumper positions as mounted when the board is delivered from Embedded Artists.

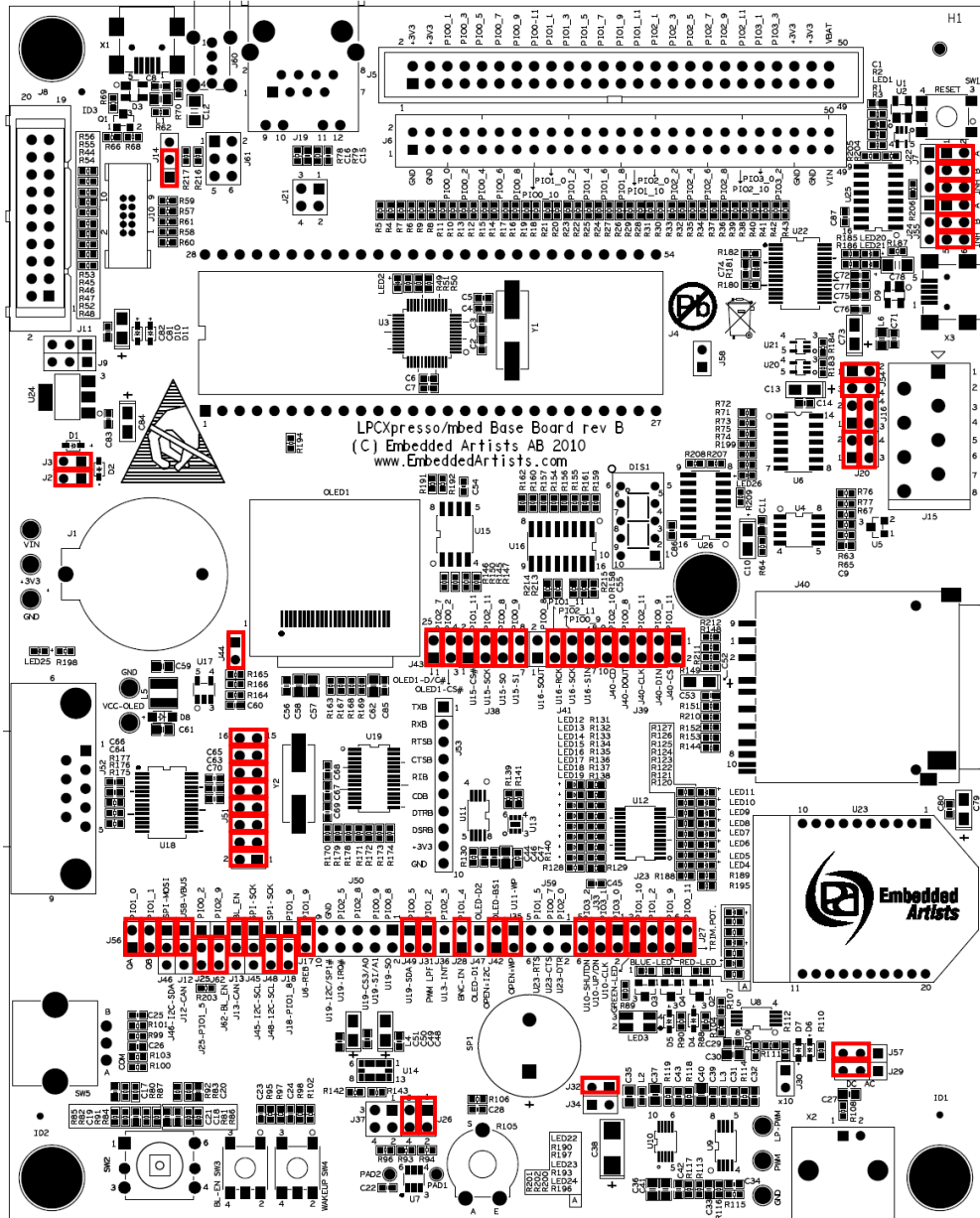

Figure 10 – LPCXpresso Base Board default Jumper Settings

3.6.1 Illegal Jumper Combinations

The *LPCXpresso Base Board* has multiple peripherals that connect to the LPC1xxx processor. There is a shortage of pins to connect to and in a few cases different peripherals must share pins. See chapter 5 for an overview of all connections.

If an output is used by several peripherals it is less of a problem. The peripherals just cannot be used simultaneously. If outputs from peripherals can drive the same signal, there is a risk of contention and damages of output drivers due to short circuit conditions. 270 ohm series resistors have been added in all places where several outputs can drive the same signal. This limits any short circuit currents to reasonable levels. To avoid the situation in the first place, avoid the following contentions:

- GPIO_4 can drive the OLED SPI-SSEL signal as well as being an output from the temperature sensor.
- GPIO_16-WAKEUP can be driven by SW4 (wakeup) as well as the analog signal from the BNC analog input (U8).
- GPIO_18 can drive the TX-EN signal as well as being an interrupt output from the accelerometer (U14).
- GPIO_33 can be driven by three interrupt sources: accelerometer (U14), light sensor (U13) and dual uart (U19).

See the jumper settings for each specific peripheral in chapter 4 .

3.7 Import Sample Applications

This section describes how you import the sample applications available on Embedded Artists support site into the LPCXpresso IDE. The example below is for the LPC1343 target board, but samples exist for other target boards as well and the process is identical (just different names on file to work with).

1. Download the zip file from the support site and store it on your computer (e.g. to C:\temp\lpc1343_base_board_100125.zip)
2. Start the LPCXpresso IDE and preferably select an empty workspace (an empty directory)
3. Press the "Import Example Projects" button from the Quickstart panel, see Figure 11.
4. A dialog window will be opened, see Figure 12. Browse to the previously downloaded zip file. Select the file and press the Next button followed by the Finish button.
5. When the zip file has been imported you will see all projects in the Project Explorer window, see Figure 13.
6. Select the project you would like to build and click the Build button in the Quickstart panel, see Figure 14.
7. Continue to section 3.8 for alternatives of how to download the program to the LPCXpresso board.

Note: All the projects with prefix Lib_ are library projects and not sample applications. These library projects contain common code used by several of the sample applications.

- Lib_CMSISv1p30_LPC13xx – Cortex Microcontroller Software Interface Standard as defined by ARM
- Lib_MCU – Drivers for peripherals on the LPC1343/LPC1114 microcontroller
- Lib_EaBaseBoard – Drivers for peripherals on the Embedded Artists LPCXpresso Base Board
- Lib_FatFs_SD – ChaN's FAT Fs module ported to the LPCXpresso base Board (used with the MMC/SD card interface).

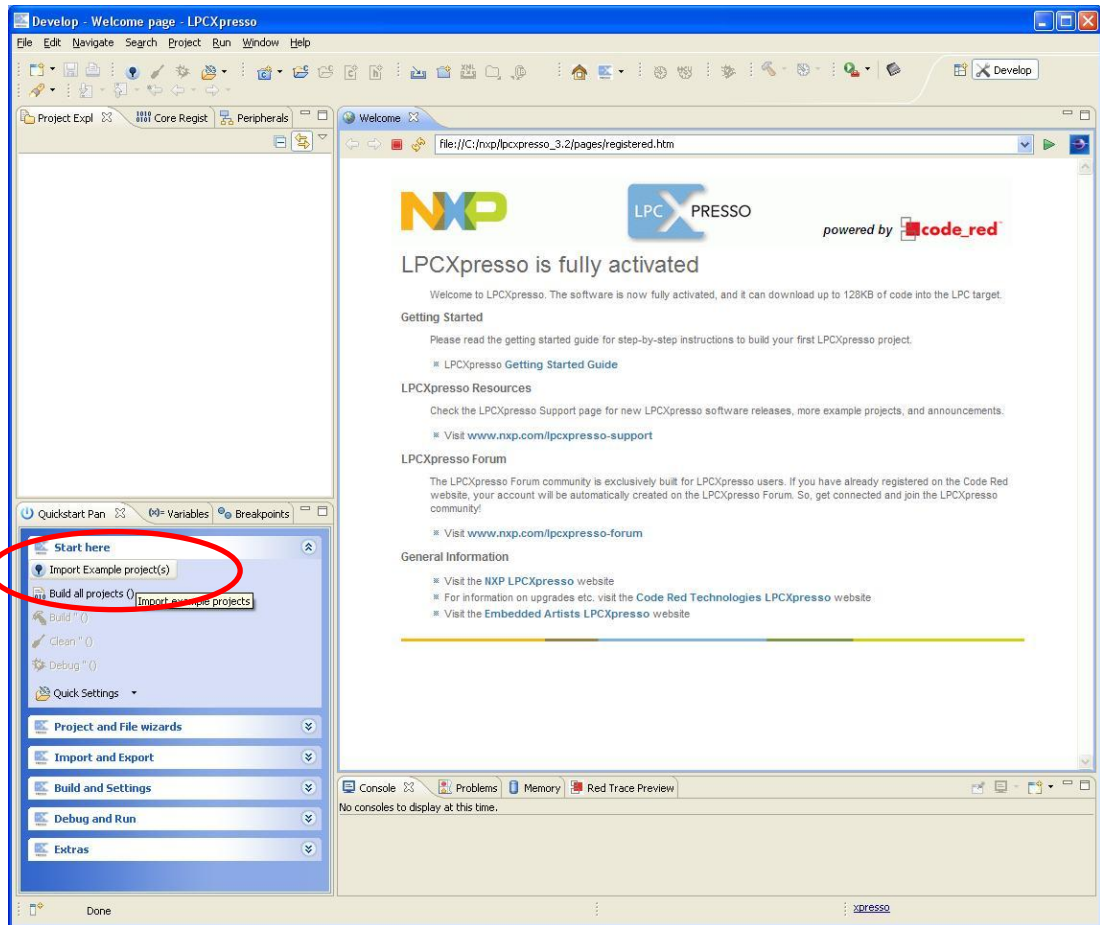

Figure 11 – Import project

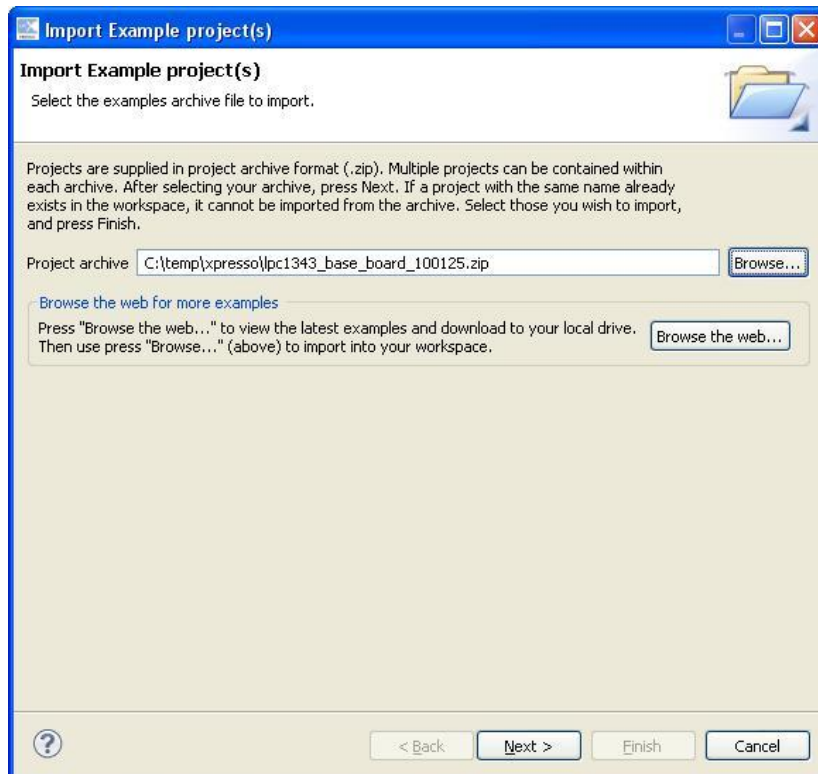

Figure 12 – LPCXpresso Import Dialog

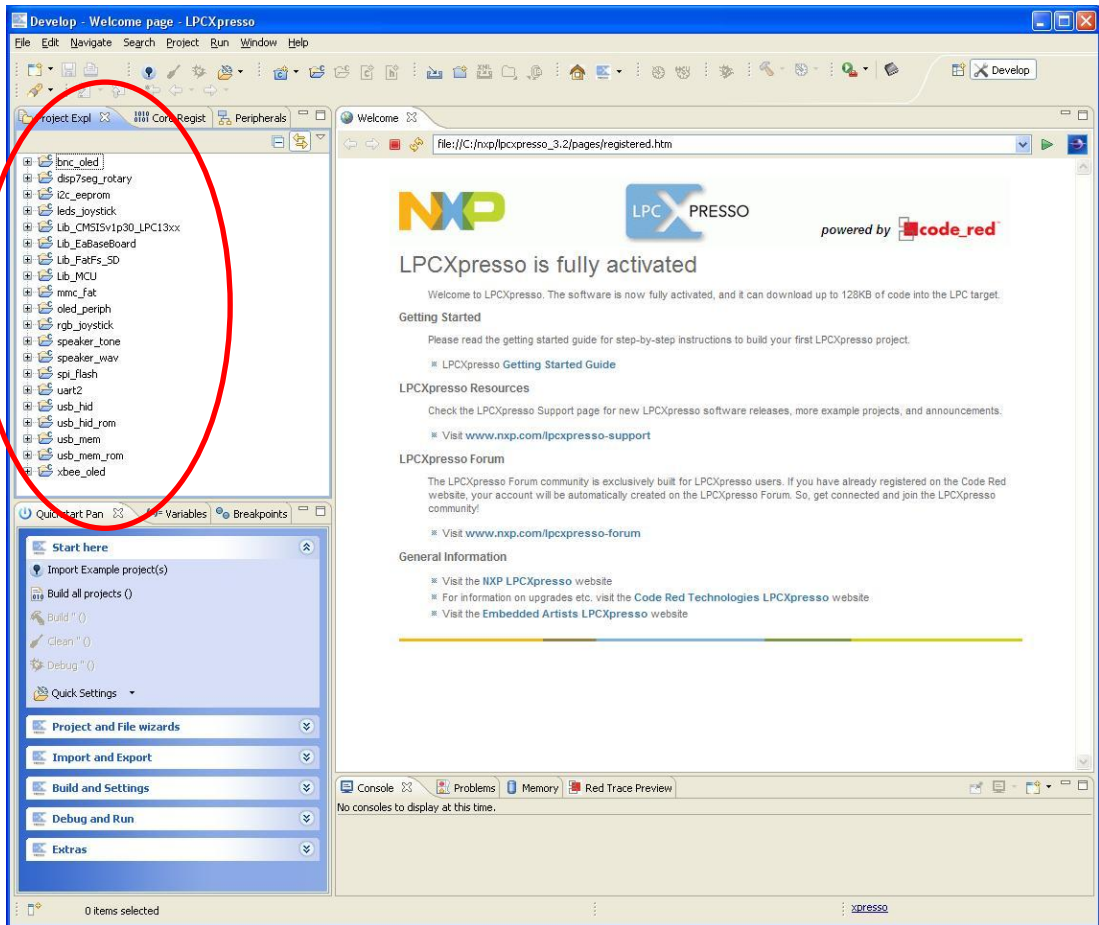

Figure 13 – LPCXpresso imported projects

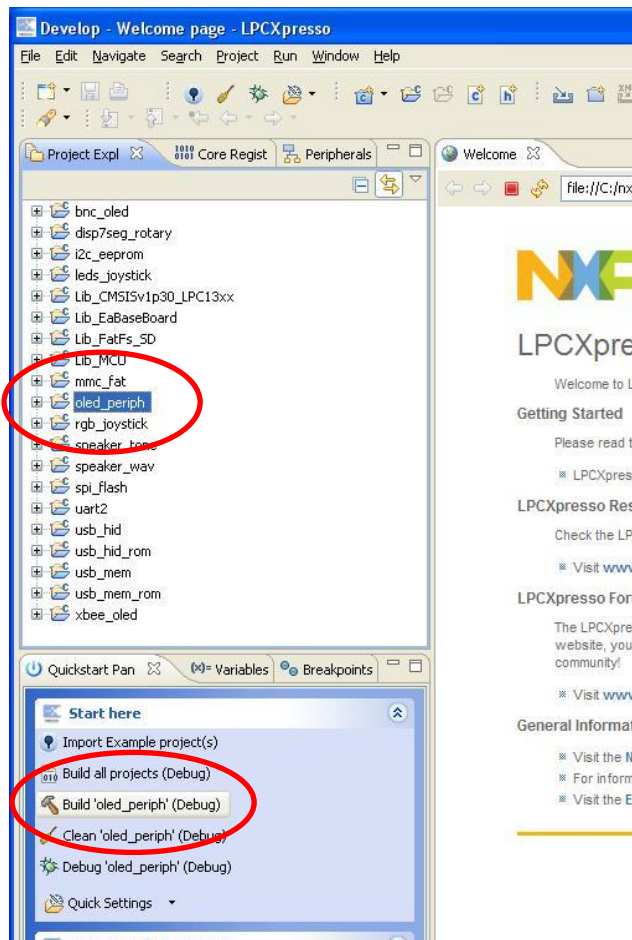

Figure 14 – LPCXpresso Build button

3.8 Demo Application

A suitable application to start with when checking the functionality of the LPCXpresso Base Board is the application called demo. This application is using several of the peripherals, such as the accelerometer, LEDs (connected to I/O port expander), joystick, OLED display, rotary switch, 7-segment display, SW3 button, speaker, trim potentiometer and RGB LED.

- 3 out of the 16 LEDs will always be lit and by tilting the board the LEDs that are lit will change (as a moving) bar. The way you move the board (in y-axis) will change the direction and speed of this bar.
- The joystick can be used to draw on the OLED display. It is like moving a pen you never lift from the paper. By using the center key on the joystick the display is cleared.
- Rotating the rotary switch will change which digit (0 to 9) is shown on the 7-segment display.
- Pressing the SW3 button will start playing a melody.
- Turning the trim potentiometer will turn on/off the RGB LEDs

Please **note** that P1.10 is used both to control power to the OLED display and to one of the RGB LEDs. This means that by changing the position of the trim potentiometer you can turn on/off both the green LED and the OLED display.

For the demo to work on LPC176x target boards J62 shall be in position 2-3 (which is the default position). Pressing SW3 will then play a melody. However, J62 should normally be in position 1-2 for LPC176x target boards (which is not the default position) in order to be able to invoke the ISP mode (be pulling P2.10 low during reset).

3.9 Program Download

3.9.1 Using LPCXpresso IDE/Debugger

If you are using the LPCXpresso IDE to develop and build your applications you can directly download the program to the LPCXpresso Board from within the IDE.

1. Make sure you have connected a USB cable (mini-B to A) between your computer and the LPCXpresso LPC1xxx board, see Figure 3 (USB interface 2).
2. Build your application as mentioned in section 3.7.
3. Click the Debug button in the Quickstart panel, see Figure 15. When the program has been downloaded, execution will stop at the first breakpoint which is the main function.
4. Press the F8 key on your keyboard to continue execution.

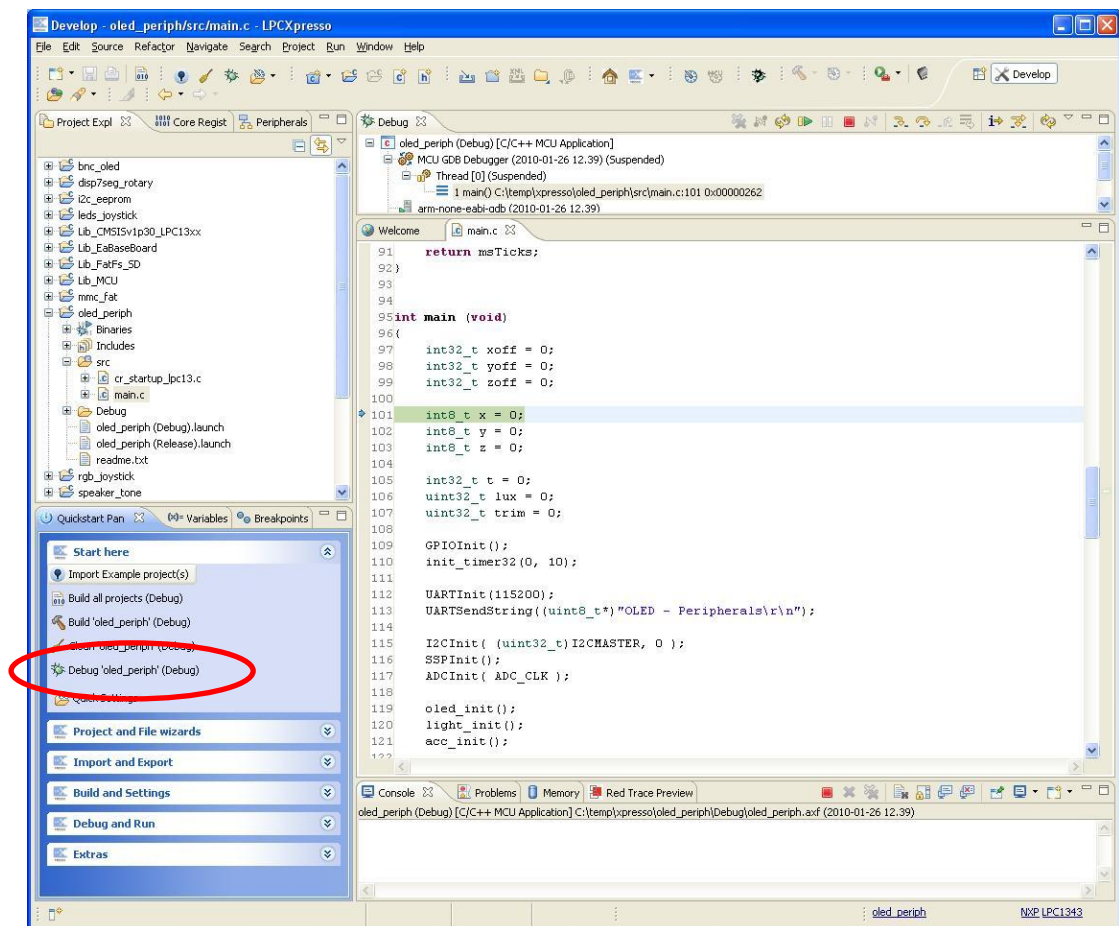

Figure 15 – LPCXpresso Debugging View

3.9.2 Using USB Boot Mode (LPC1343)

The LPC1343 supports In-System Programming (ISP) from the USB port through enumeration as a Mass Storage Class Device, i.e., you can drag and drop a binary file to the drive associated with the LPC1343.

This section describes how you generate the binary file, adds the necessary checksum to the binary file and downloads the file to the target while it is mounted on the LPCXpresso Base Board.

For this to work you need to have some jumpers correctly set. If you have all jumpers in default position as described in section 3.6 USB boot mode will work; otherwise please check the following.

- USB interface – jumpers described in section 4.5.
- SW3 button – jumper described in section 4.6.1. You also need to make sure that the BL_EN signal is connected to GPIO_24-BL_EN signal, see section 4.1.1.1 and Figure 22.

After you have checked the jumper settings continue with the steps described below.

1. Build your application in the LPCXpresso IDE as mentioned in section 3.7.
2. Right-click on the generated axf file, go to the Binary Utilities menu and select Create binary. See Figure 16.
3. Open a command prompt in the directory containing the axf file. This can be done from the Utilities menu, see Figure 17.
4. Update the binary file with a correct checksum. In the example below it is assumed that you are using LPCXpresso IDE 3.2 installed in C:\nxp\lpcxpresso_3.2. It is also assumed that you are using a LPC1343 and the binary file is named oled_periph.bin.

```
C:\nxp\lpcxpresso_3.2\bin\checksum.exe -p lpc1343 -v oled_periph.bin
```

5. You need to have a USB cable (mini-B to A) connected between your computer and the USB interface (interface 3 as shown in Figure 3).
6. Hold down the SW3 button and then press and release the reset button on the LPCXpresso base board. A storage device named CRP DISABLD will now appear on your computer, see Figure 18.
7. Open the Mass storage device and you will find a file named firmware.bin. Delete this file and then copy the file created in step 4 above to the CRP DISABLD drive.
8. Reset the board and your application will start.

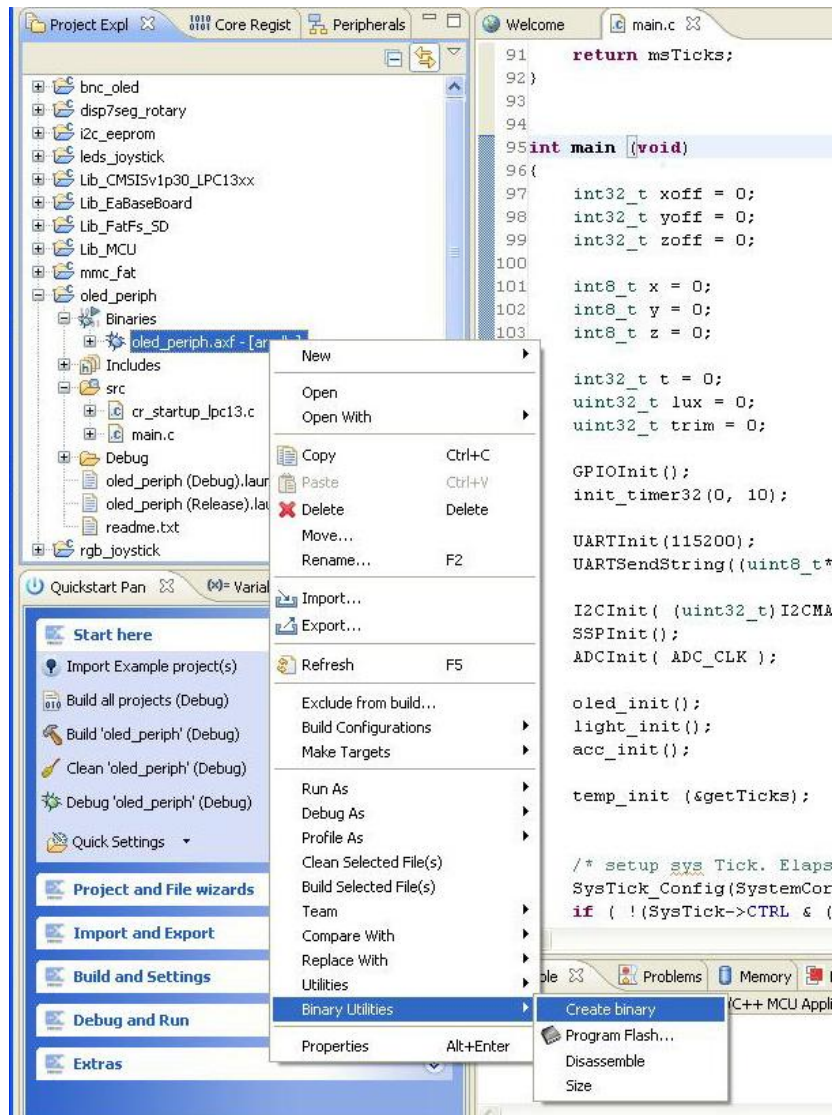

Figure 16 – LPCXpresso IDE Create a Binary File

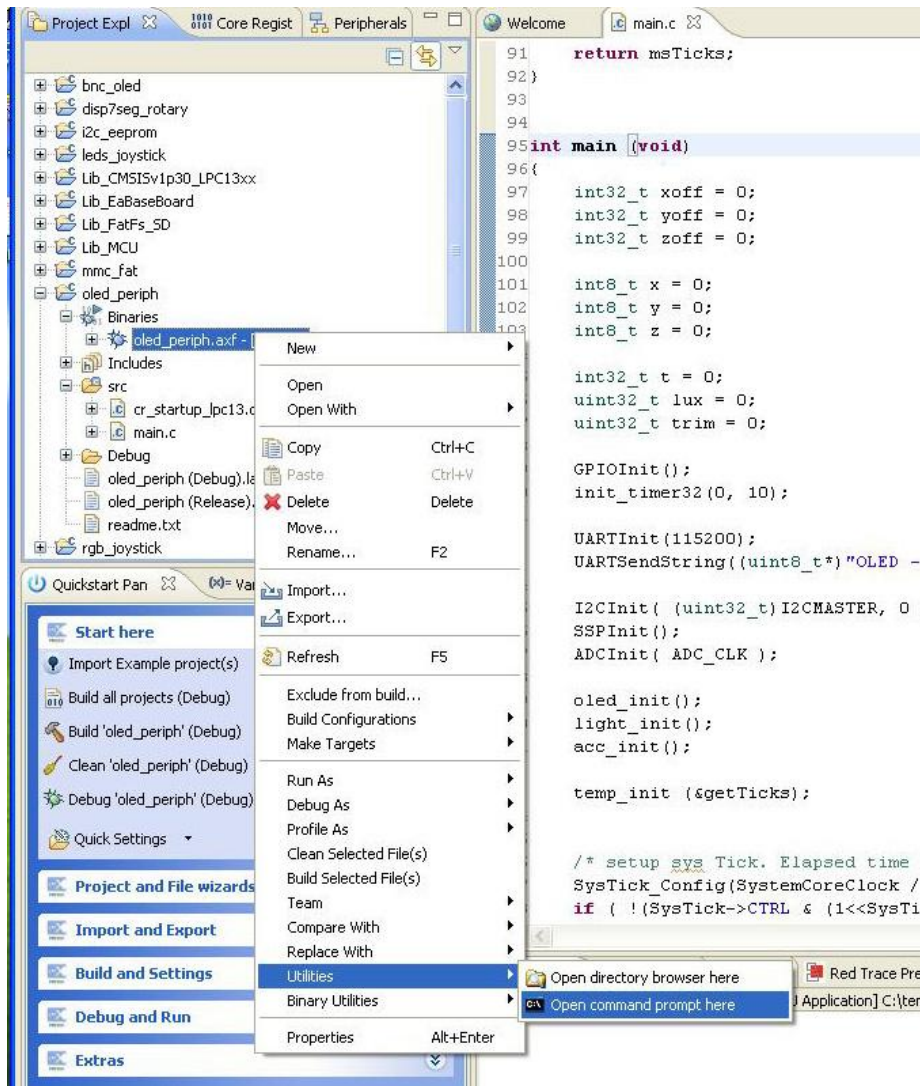

Figure 17 – LPCXpresso IDE Open Command Prompt

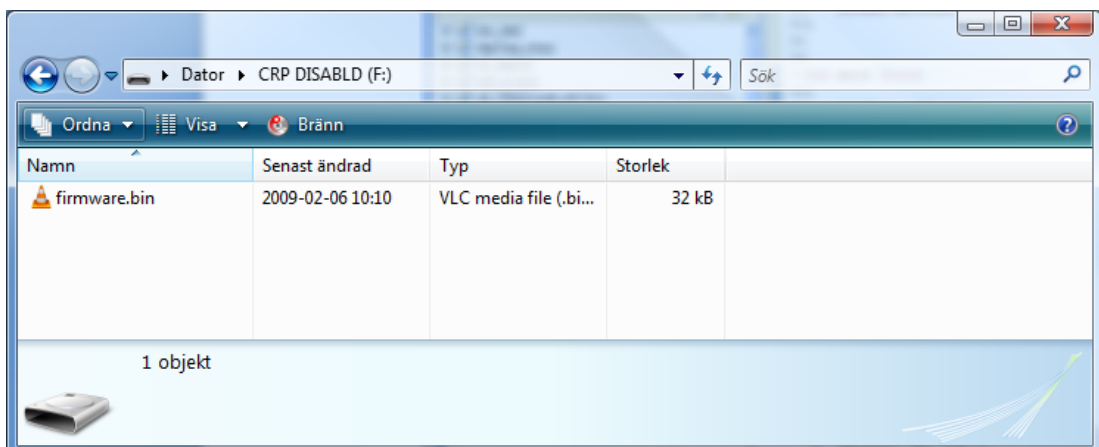

Figure 18 – Mass Storage Device

3.9.3 Using UART (ISP) Boot Mode for LPC1343 / 1227 / 11C24 / 11U14 / 1114

The LPC1343 / 1227 / 11C24 / 11U14 / 1114 all supports In-System Programming (ISP) from the UART.

This section describes how you generate the hex file and then download the file to the target while it is mounted on the LPCXpresso Base Board.

For this to work you need to have some jumpers correctly set. If you have all jumpers in default position, as described in section 3.6, all you need to do is **remove** the USB_VBUS jumper. This jumper is shown in Figure 41. If USB_VBUS is connected the LPC1343 (note that this doesn't apply for the other MCU:s) will not enter UART boot mode, only USB boot mode. If you don't have the jumpers in default position please make sure you at least have the UART related jumpers set as described in sections 4.1.1 and 4.1.1.1.

After you have checked the jumper settings continue with the steps described below.

1. Download and install Flash Magic (<http://www.flashmagictool.com/>). Always use the latest version.
2. Build your application in the LPCXpresso IDE as mentioned in section 3.7.
3. Open a command prompt in the directory containing the axf file. This can be done from the Utilities menu, see Figure 17.
4. Convert the axf file to a hex file. In this example it is assumed that your sample application is named oled_periph.

```
arm-none-eabi-objcopy -O ihex oled_periph.axf oled_periph.hex
```

5. Start Flash Magic, select correct Device, COM Port (the COM port associated with the target, section 3.4.1 describes the USB-to-UART bridge). Set baud rate to 115200, Interface to None and Oscillator to 12 MHz. Browse to the hex file you would like to download, see Figure 19 for an example.
6. Click the Start button and your application will be downloaded to the target.

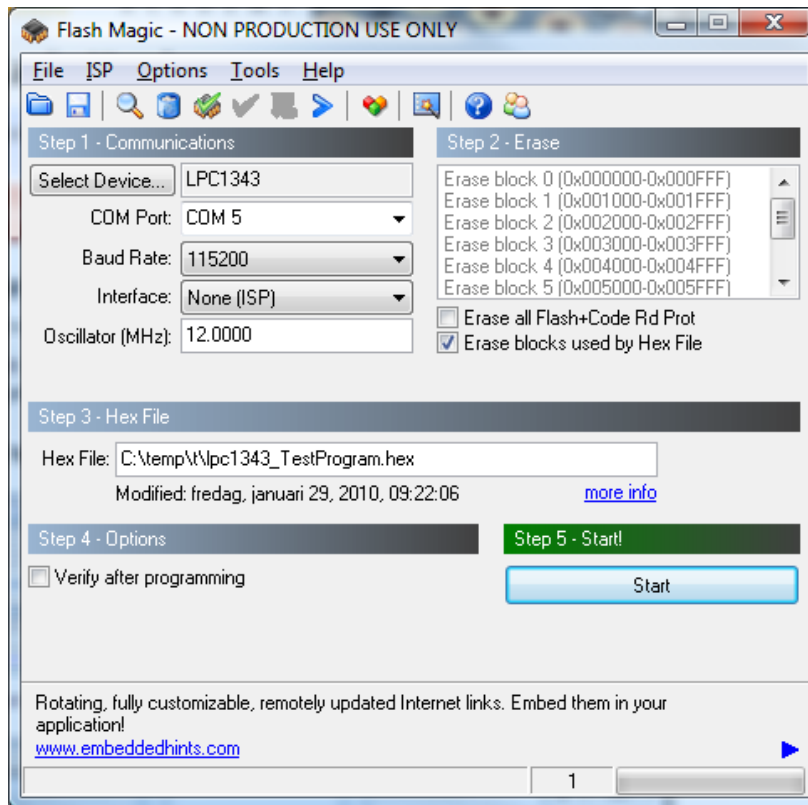

Figure 19 Flash Magic

3.9.4 Using UART (ISP) Boot Mode for LPC176x

The LPC176x chip supports In-System Programming (ISP) from the UART. ISP mode can be enabled when jumper J62 is placed in position 1-2 (note that this is not the default position). See section 6.2 for details.

UART channel #0 for LPC176x is however not connected to the USB-to-UART bridge (described in section 3.4.1). This is the UART channel used in ISP mode. **This means that it is not possible to use ISP mode directly for the LPC176x on the LPCXpresso Base Board.** The reason for this is compatibility with the mbed-module.

However, if UART channel#0 is connected to a serial channel (RS232 or USB-to-UART bridge) via an external adapter board (note: not provided with the LPCXpresso Base Board) it is possible to use Flash Magic to download program code to the LPC176x.

4 Peripherals and Jumper Settings

This chapter contains information about the peripherals of the *LPCXpresso Base Board* and how to set the different jumpers on the board. The schematic can be downloaded in pdf from the support page, and is recommended to have printed out while reading this chapter.

4.1 UART

The LPC1xxx UART can be connected to one of three different peripherals:

- USB-to-UART bridge, see schematic page 11, U22. See subsection 4.1.1
- RS422/485 interface, see schematic page 5, U6. See subsection 4.1.2
- RF-module interface, see schematic page 11, U23. See subsection 4.1.3

A multiplexer (U25 on schematic page 11) selects to which peripheral the UART is connected. The A and B inputs selects which source. The INH input shall be grounded to enable the multiplexer.

It is possible to not connect the UART to any of three peripherals listed above, and instead connect to an external source, via the expansion connectors (schematic page 3). In this case, the INH input shall be high which is that same as not inserting the INH jumper (pin 5-6 of J7). The multiplexer circuit is then disconnected.

4.1.1 USB-to-UART Bridge – U22

This is the default mode. Insert all three jumpers in J7 (schematic page 11), as illustrated in Figure 20.

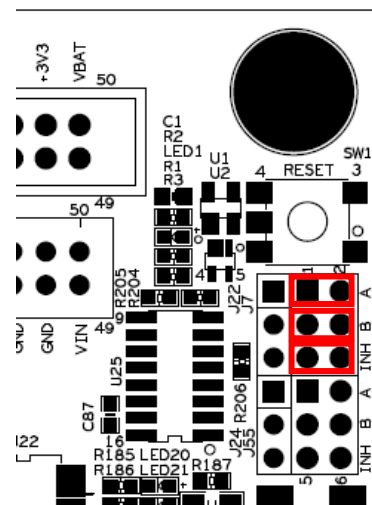

Figure 20 – Jumper Setting: UART to USB-to-UART bridge

4.1.1.1 ISP-option

The USB-to-UART bridge can automatically activate the bootloader mode of the LPC1xxx. A program image can then be downloaded via the UART channel. The RTS signal can pull pin GPIO_24-BL_EN low, which enabled bootloader mode after reset. The DTR signal can pull pin GPIO_0-RESET low, which is the reset input. By inserting both jumpers in J54 (schematic page 11) the USB-to-UART bridge (U22) can control the GPIO_0-RESET and GPIO_24-BL_EN signals via RTS and DTR, see Figure 21.

Upper: DTR to GPIO_0-RESET (reset)
 Lower: RTS to GPIO_24-BL_EN (bootload en)

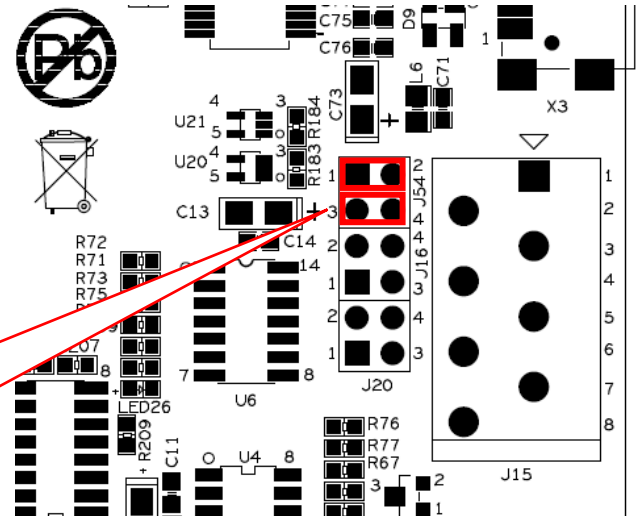

Figure 21 – Jumper Setting: Enable ISP via USB-to-UART bridge, J54

The BL_EN signal must be connected to GPIO_24-BL_EN signal. This is accomplished by inserting a jumper in J13, pin 1-2 (schematic page 5). See Figure 22 for details.

Note that the pinning for the LPC176x is different but the functionality is the same. Instead of GPIO_24-BL_EN it is GPIO_37 that is pulled low on the LPC176x to enable ISP operation. See also section 4.6.1 for settings of J62. The LPC176x also has a separate reset input (instead of the GPIO_0-RESET for the other LPC1xxx MCU:s).

Note that ISP mode can be activated on LPC176x but the LPCXpresso Base Board has no connection to UART #0. Hence it is not possible to actually download a program image without an external adapter (that connects to UART#0).

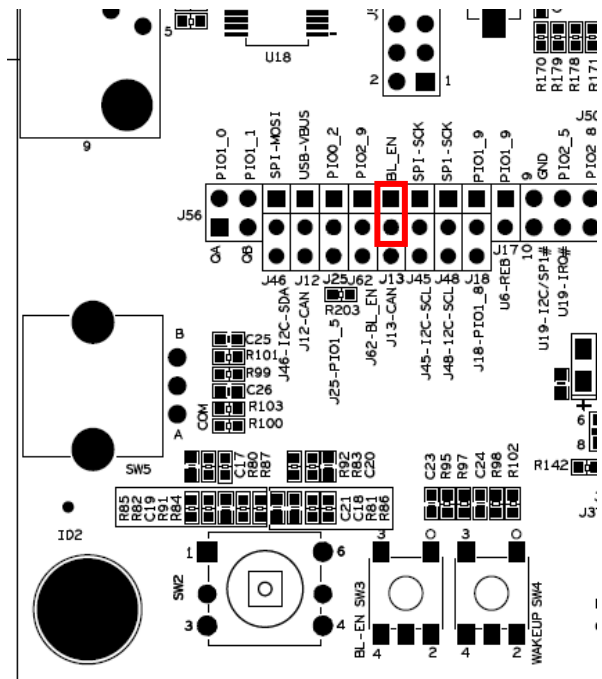

Figure 22 – Jumper Setting: Enable ISP via USB-to-UART mode, J13

4.1.2 RS422/485 – U6

To connect the UART to the RS422/485 transceiver, insert two jumpers in J7 (schematic page 11), as illustrated in Figure 23.

A RS422/485 transceiver must control the Rx- and Tx-paths. This is accomplished via J17 and J18. The subsections below described the differences in jumper settings for RS422 and RS485, respectively.

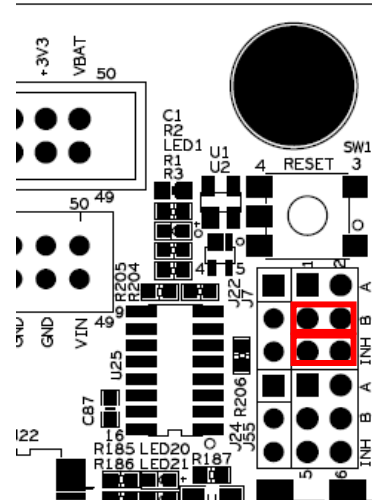

Figure 23 – Jumper Setting: UART to RS422/485, U6

4.1.2.1 RS422

In RS422, the Rx- and Tx-paths must be controlled independently since both can be active simultaneously (full duplex). Rx-enable is controlled by GPIO_28 (insert J17) and is active low. Tx-enable is controlled by GPIO_18 (insert J18 in position 2-3) and is active high. See Figure 24 for jumper details.

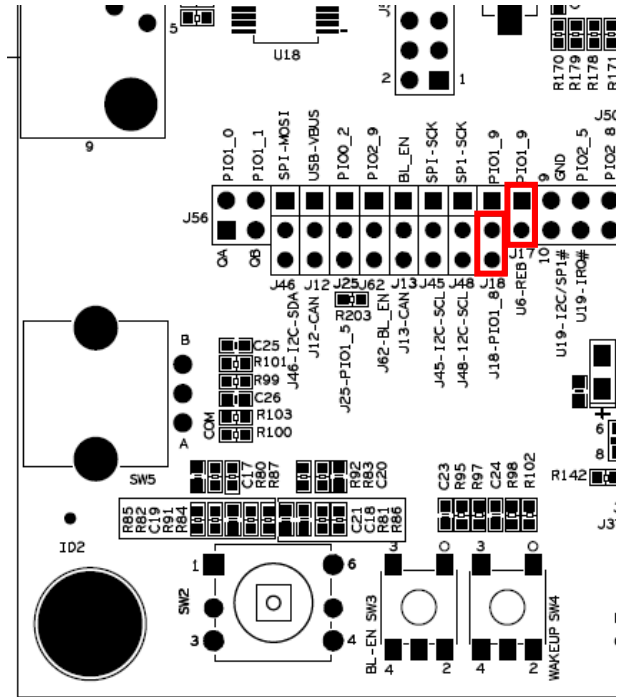

Figure 24 – Jumper Setting: Enable RS422 control

It is possible to have 120 ohm termination resistors (R76 and R77 on schematic page 5) on the Rx- and Tx-data paths, respectively. See Figure 25 for jumper details.

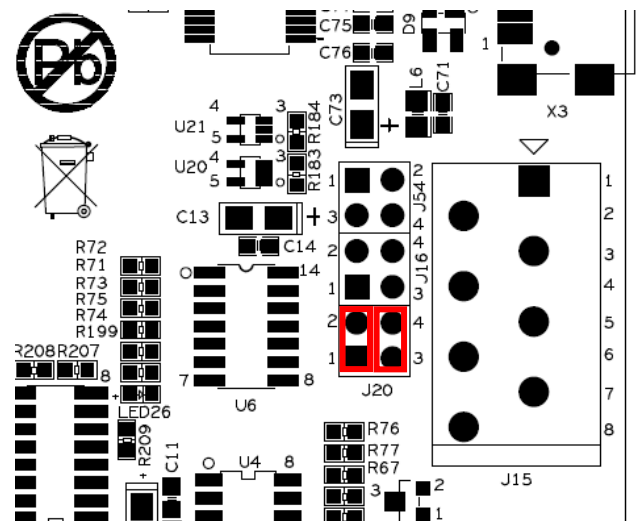

Figure 25 – Jumper Setting: Rs422 termination

4.1.2.2 RS485

In RS485, the Rx- and Tx-paths can be controlled together since they are not active simultaneously (half duplex). GPIO_28 controls both Rx and Tx. When GPIO_28 is high, Tx is enabled, and when GPIO_28 is low, Rx is enabled. Insert J17 and J18 in position 1-2. See Figure 26 for jumper details.

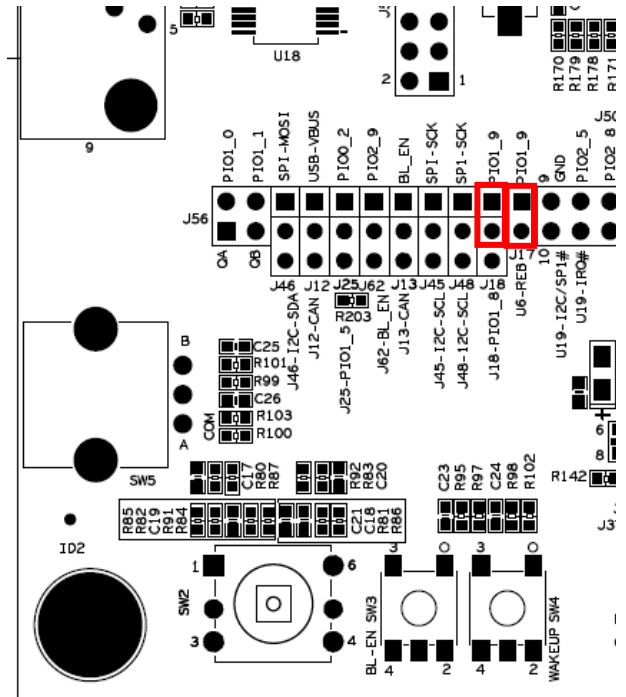

Figure 26 – Jumper Setting: Enable RS485 control

It is possible to connect the Rx- and Tx-data paths via jumper J16 (on schematic page 5). Only one twisted pair used to communicate between nodes. It is also possible to add a 120 ohm termination resistor (R77 on schematic page 5) on the common Rx- and Tx-data path. See Figure 27 for jumper details.

Upper: J16, data path jumpers
Lower: J20, pin 1-2, termination jumper

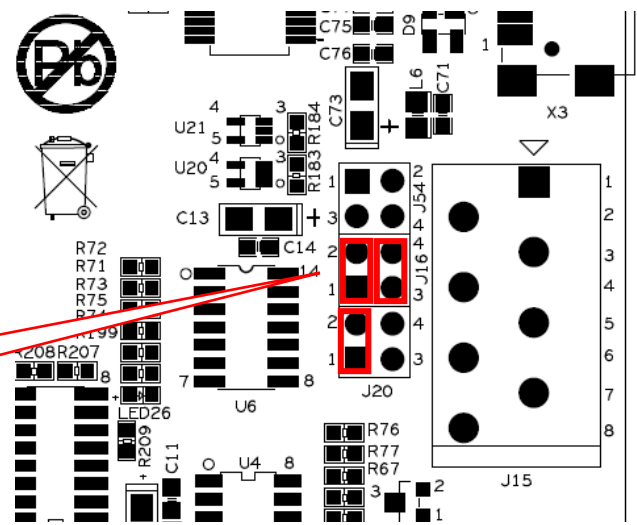

Figure 27 – Jumper Setting: Enable RS485 data and termination

4.1.3 RF-module – U23

To connect the UART to the RF-module, U23 (interface socket for XBee® modules from Digi International Inc.), insert two jumpers in J7 (schematic page 11), as illustrated in Figure 28.

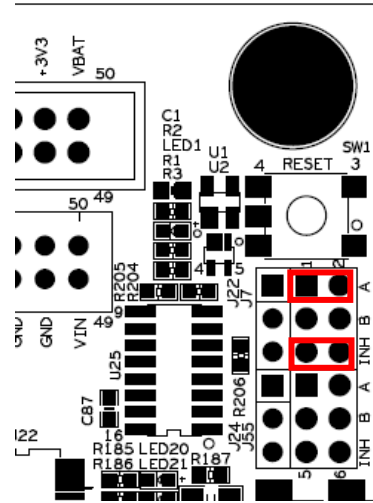

Figure 28 – Jumper Setting: UART to RF-module

When communicating with the RF-module, sometimes extra control signals are needed. J59 on schematic page 11 allows these to be connected. Figure 29 illustrates where the J59 can be found on the board.

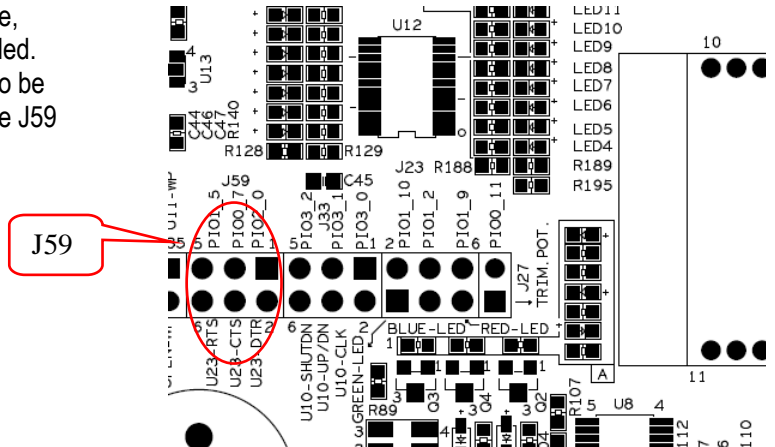

Figure 29 – Jumper Setting: RF-module extra signals

4.2 I2C

The LPC1xxx I2C-bus is connected to the following peripherals:

- E2PROM (24LC08), see schematic page 8, U11. See subsection 4.2.1
- Port expander (PCA9532), see schematic page 8, U12. See subsection 4.2.2
- Light sensor (ISL29003), see schematic page 8, U13. See subsection 4.2.3
- Accelerometer (MMA7455), see schematic page 8, U14. See subsection 4.2.4
- OLED display, see schematic page 10, OLED1. See subsection 4.4.1
- Dual UART (SC16IS752), see schematic page 10, U19. See subsection 4.4.2

Note that these peripherals are always connected to the I2C-bus with the exception of the OLED display and UART-bridge (SC16IS752). These two peripherals have both I2C and SPI interfaces and they are described in a different section.

The schematic specifies the I2C-addresses used (schematic page 8 and 10).

4.2.1 E2PROM, 24LC08 – U11

U12 is always connected to the I2C-bus. Write protect status on the memory area in U11 can be controlled by jumper J35 (schematic page 8). See Figure 30 for details.

Inserted: Write operations enabled on U11
Open: Write protect enabled on U11

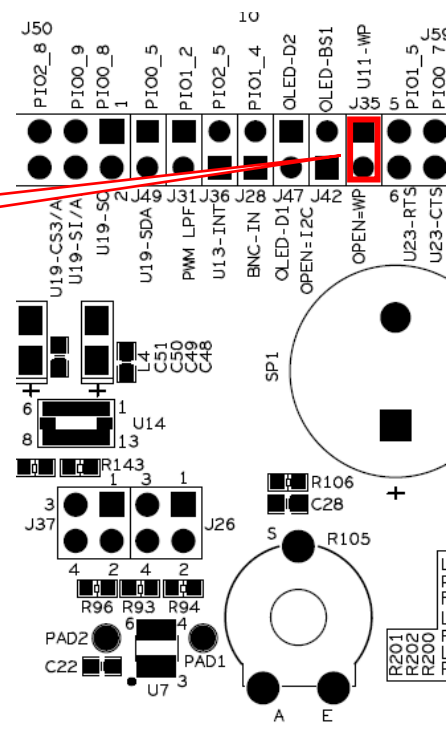

Figure 30 – Jumper Setting: E2PROM, 24LCD08 write protect

4.2.2 Port Expander, PCA9532 – U12

There are no jumpers of the 16-bit I2C-port expander. U12 is always connected to the I2C-bus.

4.2.3 Light Sensor, ISL29003 – U13

U13 is always connected to the I2C-bus. There is an interrupt output that can be connected to GPIO_33 via J36 (schematic page 8). See Figure 31 for details. Make sure there is no other driver on the GPIO_33 signal when using it as interrupt signal. There is a 270 ohm series resistor to prevent damages in case there is more than one driver of the signal.

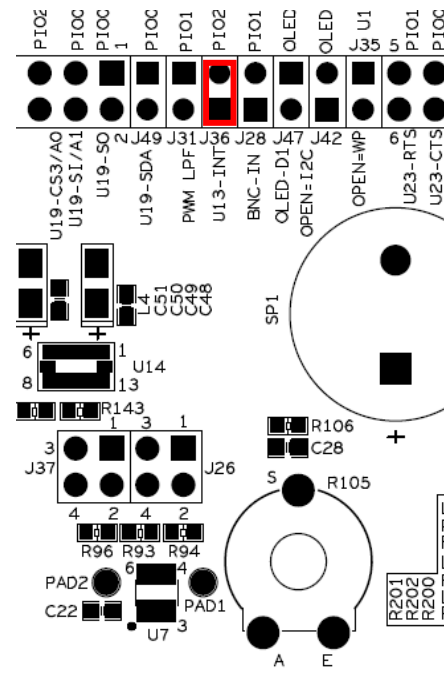

Figure 31 – Jumper Setting: Light sensor, ISL29003 interrupt output

4.2.4 Accelerometer, MMA7455 – U14

U14 is always connected to the I2C-bus. There are two interrupt outputs that can be connected to GPIO_18 and GPIO_33 via J37 (schematic page 8). See Figure 32 for details. Make sure there are no other drivers on the GPIO_18 and GPIO_33 signals when using them as interrupt signals. There are 270 ohm series resistors to prevent damages in case there is more than one driver of the signals.

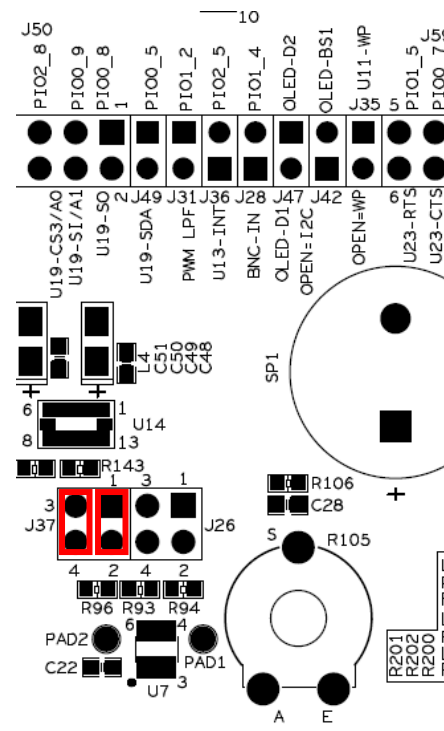

Figure 32 – Jumper Setting: Accelerometer, MMA7455 interrupt outputs

4.3 SPI

The LPC1xxx SPI-bus is connected to the following peripherals:

- Dataflash (AT45DB016), see schematic page 9, U15. See subsection 4.3.1
- 7-segment display via shift register, see schematic page 9, U16. See subsection 4.3.2
- SD/MMC memory card interface, see schematic page 9, J40. See subsection 4.3.3
- Dual UART (SC16IS752), see schematic page 10, U19. See subsection 4.4.2
- OLED display, see schematic page 10, OLED1. See subsection 4.4.1

These peripherals can all be connected to the SPI-bus. The OLED display and the UART-bridge (SC16IS752) can alternatively also be connected to the I2C-bus. These two peripherals have both I2C and SPI interfaces and they are described in a different section.

The Dataflash, 7-segment display and SD/MMC memory card interface are all controlled (chip select – SSEL) by GPIO_30. That means that only one of these three peripherals can be used at a time. A multiplexer (U26 on schematic page 9) selects to which of these three peripheral that GPIO_30 connects to, and controls the respective SSEL input signal. The A and B inputs select which one. The INH input shall be grounded to enable the multiplexer.

Note that some jumpers can interfere with the SPI-communication. J58 (schematic page 10) must not be inserted. J41 (pin 1-2, schematic page 9) shall normally not be inserted unless only the 7-segment display is used.

4.3.1 Dataflash, AT45DB016 – U15

The Dataflash chip, U15, can be connected to the SPI-bus. Insert all four jumpers in J38 (schematic page 9), as illustrated in Figure 33, in order to connect all SPI signals to U15.

Note that some jumpers can interfere with the SPI-communication. J58 (schematic page 10) must not be inserted. J41 (pin 1-2, schematic page 9) shall normally not be inserted unless only the 7-segment display is used.

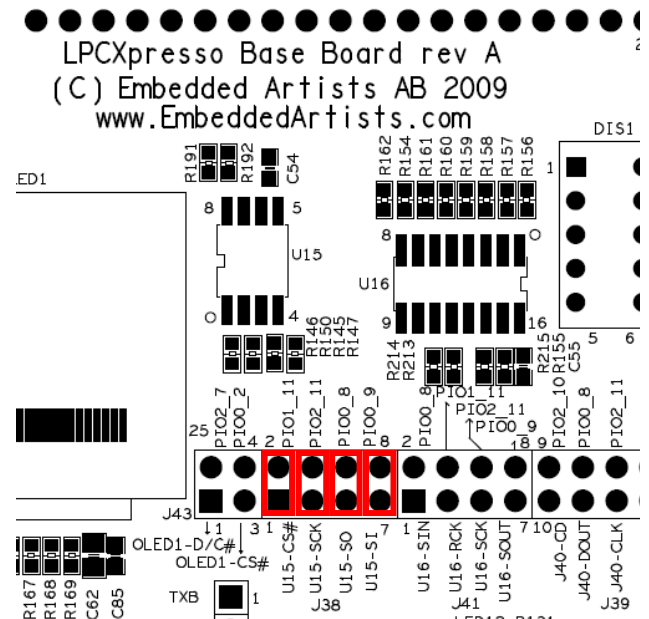

Figure 33 – Jumper Setting: J38 for Dataflash, U15

In order to connect GPIO_30 to SSEL of U15, set jumpers for J55 according to Figure 34.

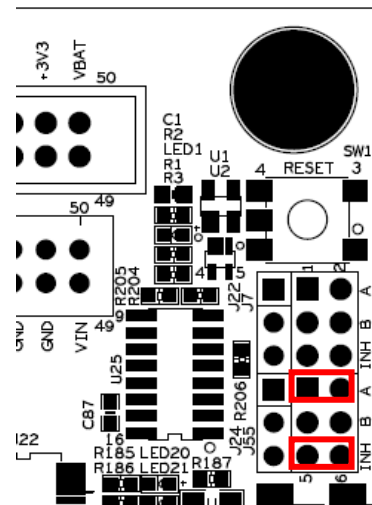

Figure 34 – Jumper Setting: PIO1_11, SSEL to Dataflash, U15

4.3.2 7-segment display via shift register – U16

The 7-segment display shift register, U16, can be connected to the SPI-bus. Insert three (of the four) jumpers in J41 (schematic page 9), as illustrated in Figure 35, in order to connect the SPI signals to U16.

J41, pin 1-2 shall normally not be inserted. This is the output from the shift register. It can only be connected to the SPI-MISO signal if this is the only chip connected on the SPI-bus. The reason for this is that the shift register always drive the output signal, i.e., it is never in high-impedance state (regardless the state of the SSEL input). Note that the silkscreen text around J41 (for rev A of the board) is wrong. The text "U16-SOUT" should rather be "U16-SIN". Similarly, the text "U16-SIN" should rather be "U16-SOUT".

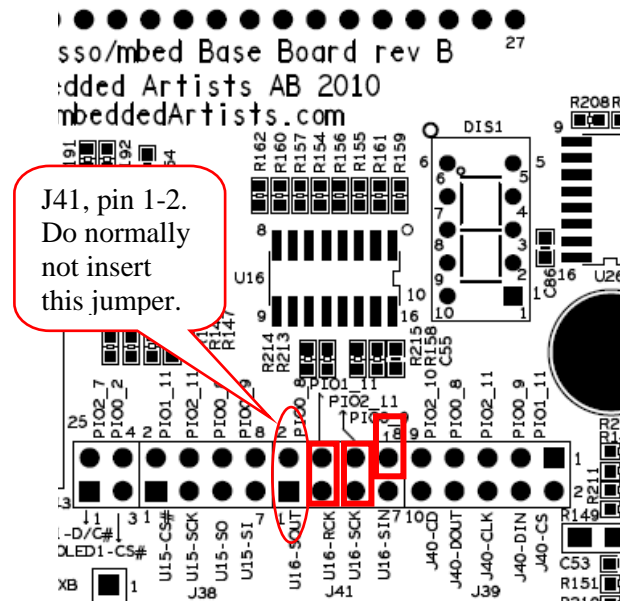

Figure 35 – Jumper Setting: J41 for shift register, U16

In order to connect GPIO_30 to SSEL of U16, set jumpers for J55 according to Figure 36.

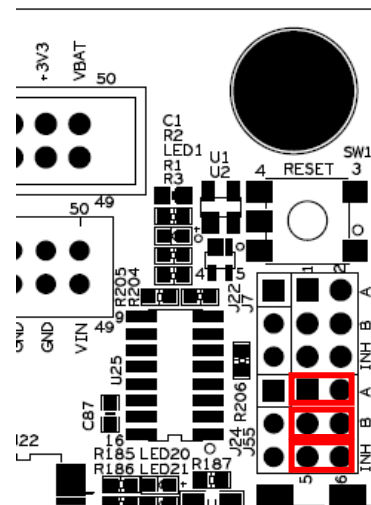

Figure 36 – Jumper Setting: PIO1_11, SSEL to shift register, U16

4.3.3 SD/MMC memory card interface

The SD/MMC memory card interface connector, J40, can be connected to the SPI-bus. Insert all five jumpers in J39 (schematic page 9), as illustrated in Figure 37, in order to connect all SPI signals to J40 (and ultimately the SD/MMC memory card).

Note that the memory card can only be interfaced in the simpler and lower data rate SPI-mode.

Also note that J39, pin 9-10, is optional. It is a card detect signal (active low) that is connected to GPIO_38. It is not always needed. If not, simply do not insert this jumper and GPIO_38 can be used for other purposes.

Note that some jumpers can interfere with the SPI-communication. J58 (schematic page 10) must not be inserted. J41 (pin 1-2, schematic page 9) must not be inserted.

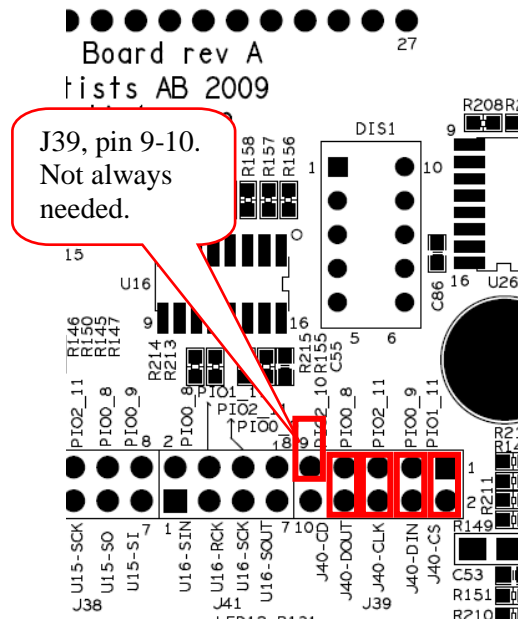

Figure 37 – Jumper Setting: J39 for SD/MMC memory card interface, J40

In order to connect GPIO_30 to CS signal of J40 (the SPI-SSEL signal), set jumpers for J55 according to Figure 38.

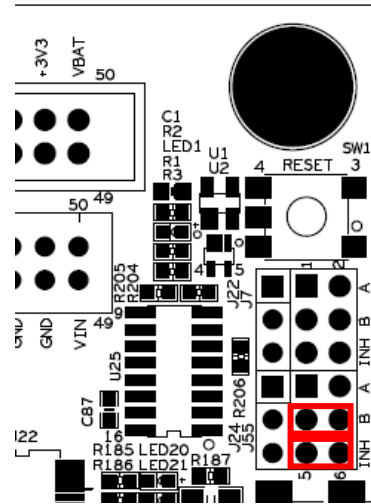

Figure 38 – Jumper Setting: PIO1_11, SSEL to SD/MMC interface, J40

4.4 I2C/SPI

There are two peripherals, as presented in the I2C and SPI sections, which can be connected to either the I2C or the SPI interfaces. These two peripherals have both I2C and SPI interfaces. The SPI interface has higher data rate but require more signals.

- OLED display, see schematic page 10, OLED1. See subsection 4.4.1
- Dual UART (SC16IS752), see schematic page 10, U19. See subsection 4.4.2

4.4.1 OLED Display

The OLED display, OLED1 (schematic page 10), can be connected either to the SPI-bus or the I2C-bus. Always insert a jumper in J44 (schematic page 10) in order to allow GPIO_29 to control the OLED-voltage (about 11V). See Figure 39 for details.

- For SPI interface (default), insert jumpers in J42, J43, J45 pin1-2 and J46 pin 1-2 (schematic page 10), as illustrated in Figure 39. Note that SPI mode is illustrated by blue jumpers.
- For I2C interface, insert jumpers in J45 pin 2-3, J46 pin 2-3 and J47 (schematic page 10), as illustrated in Figure 39. Note that I2C mode is illustrated by yellow jumpers.

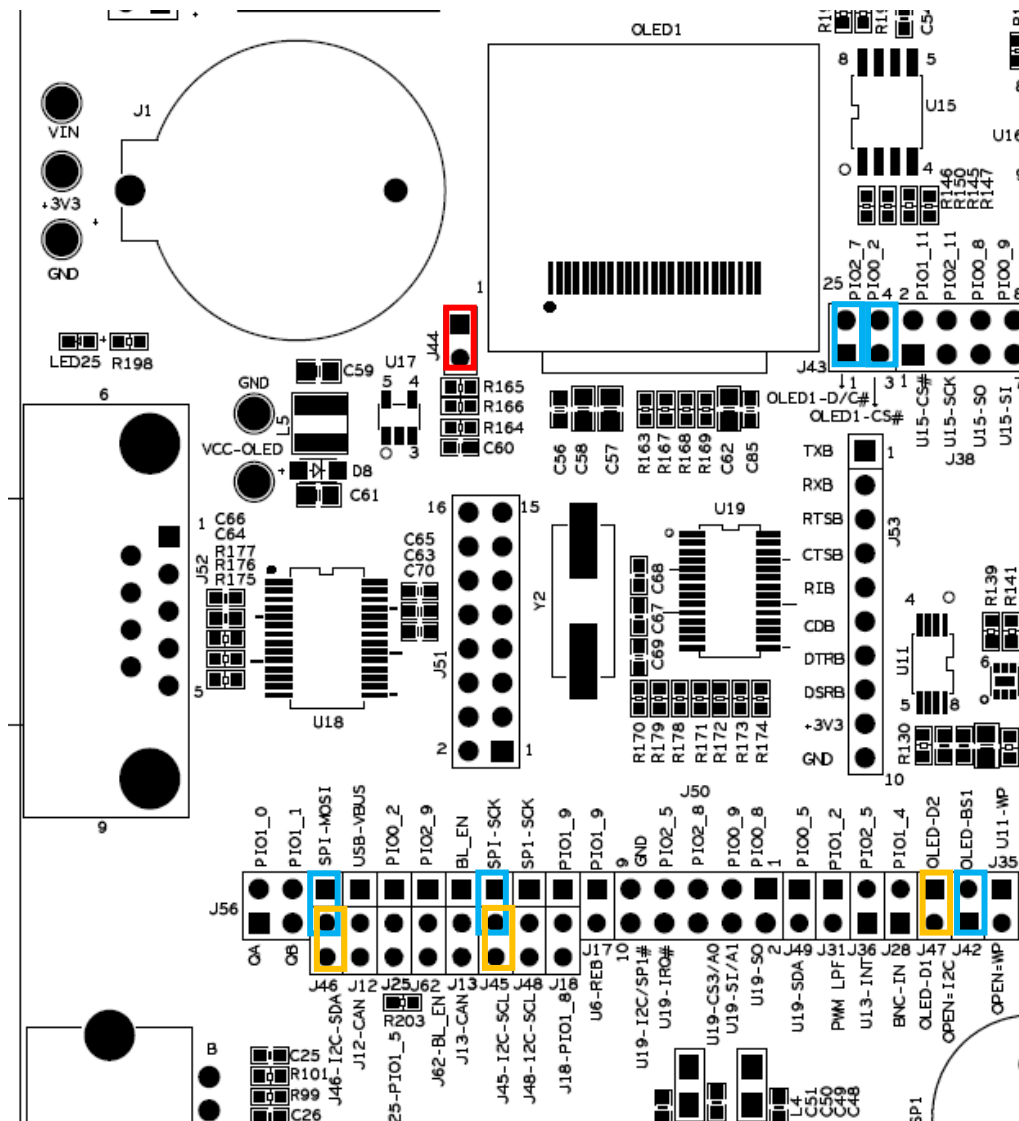

Figure 39 – Jumper Setting: OLED in SPI/I2C Mode

4.4.2 Dual UART SC16IS752 – U19

The dual UART SC16IS752, U19 (schematic page 10), can be connected either to the SPI-bus or the I2C-bus.

- For I2C interface (default), insert jumpers in J48 pin 2-3, J49 (schematic page 10), as illustrated in Figure 40. Note that I2C mode is illustrated by yellow jumpers.
- For SPI interface, insert jumpers in J48 pin1-2 and J50 (schematic page 10), as illustrated in Figure 40. Note that SPI mode is illustrated by blue jumpers.

Note that J50 pin 7-8 is optional. It is the interrupt signal from the dual uart (U19) that can optionally be connected to GPIO_33. If that is wanted, insert a jumper in J50 pin 7-8. See Figure 40 for details.

Insert all jumpers in J51 (schematic page 10) in order to connect uart channel A to the RS232 interface (U18 and J52). See Figure 40 for details.

Connector J53 carries uart channel B that can be used for custom interface.

Note that some jumpers can interfere with the SPI-communication. J58 (schematic page 10) must not be inserted. J41 (pin 1-2, schematic page 9) shall normally not be inserted unless only the 7-segment display is used.

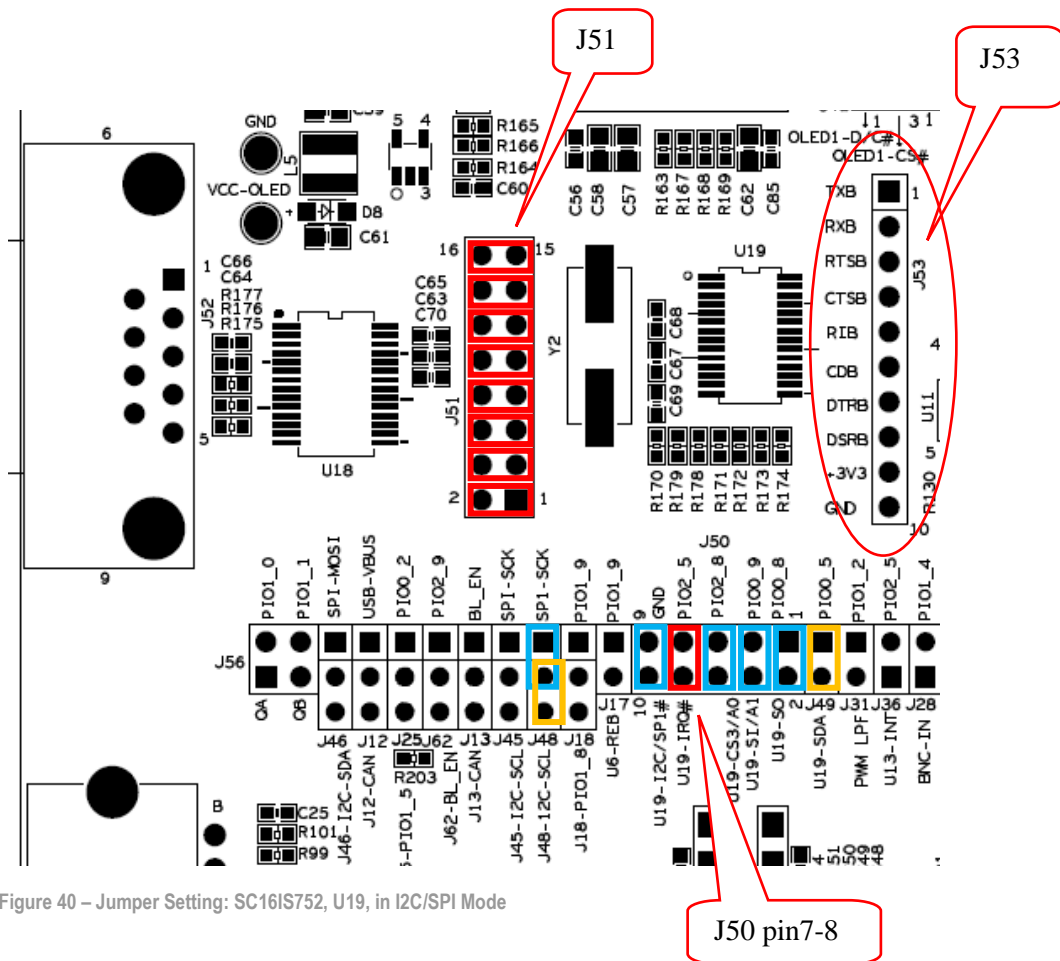

Figure 40 – Jumper Setting: SC16IS752, U19, in I2C/SPI Mode

4.5 USB Device

The LPC176x/LPC1343/11U14 USB interface can be connected to mini-B USB connector (X1, on schematic page 5). Note that the LPC1114 does not contain any USB interface. Also note that LPC11U14 has a mini-B USB connector on the LPCXpresso target board which is better to use.

The USB power signal must be connected to the VBUS sense input, GPIO_25-VBUS. This is accomplished by inserting a jumper in J12, pin 1-2. See Figure 41 for details.

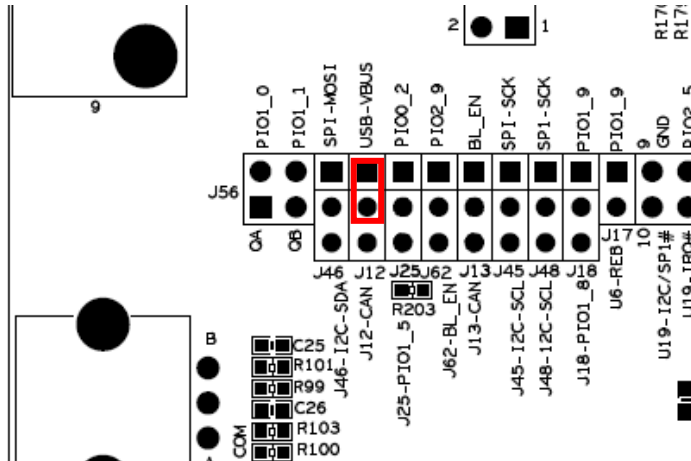

Figure 41 – Jumper Setting: USB VBUS, J12

The USB connect function is controlled by J14. If a jumper is inserted in J14, pin 1-2, the connect functionality is controlled by GPIO_19-USB_CONN. This is the default jumper position.



Figure 42 – Jumper Setting: USB Connect, J14

4.6 Direct Digital IO

The LPC1xxx is connected to a number of peripherals directly via the general purpose digital input/output pins:

- 5-key joystick), see schematic page 6, SW2. Directly connected to GPIO_8, GPIO_9, GPIO_10, GPIO_31 and GPIO_32
- Push button (BL), see schematic page 6, SW3. See subsection 4.6.1
- Push button (Wakeup), see schematic page 6, SW4. Directly connected to GPIO_16-WAKEUP. See subsection 4.6.2
- Quadrature rotary switch, see schematic page 6, SW5. See subsection 4.6.3
- Temperature sensor, see schematic page 6, U7. See subsection 4.6.4

4.6.1 Push Button (BL) – SW3

See Figure 22 on page 28 for J13 settings (schematic page 5). A jumper must be inserted in J13, pin 1-2 in order to connect the signal from SW3 to GPIO_24-BL_EN (which is the bootloader enable pin for most LPC1xxx MCU:s).

The LPC176x use another bootloader enable pin (P2.10, which is the GPIO_37 signal on the LPCXpresso Base Board). Use J62 to select where to connect the BL-button, SW3. See Figure 43 for how to set jumper.

Upper pos.: BL-button to GPIO_37 (which is P2.10 on the LPC176x)
 Lower pos.: BL-button to BL_EN (GPIO_24-BL_EN)

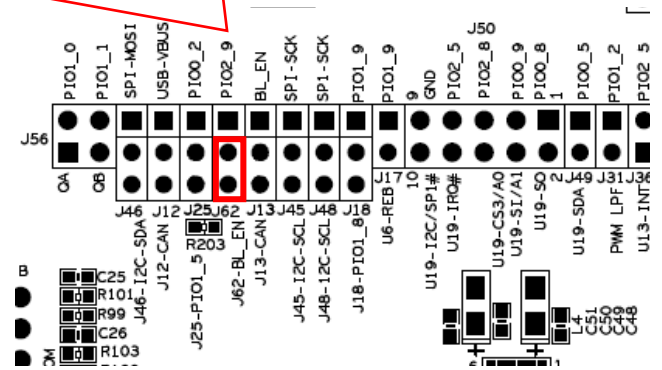

Figure 43 – Jumper Setting: J62 and BL-button

4.6.2 Push Button (WAKEUP) – SW4

GPIO_16-WAKEUP are can be driven from both SW4 and from the BNC Analog Input (U8) via J28. Note that J28 must not be inserted when SW4 is to be used. See Figure 50 for details where to find J28 (upper left side of the picture).

4.6.3 Quadrature Rotary Switch – SW5

Insert both jumpers in J56 (schematic page 6), as illustrated in Figure 44. This will connect the two signals (QA and QB) to GPIO_12 and GPIO_13, respectively.

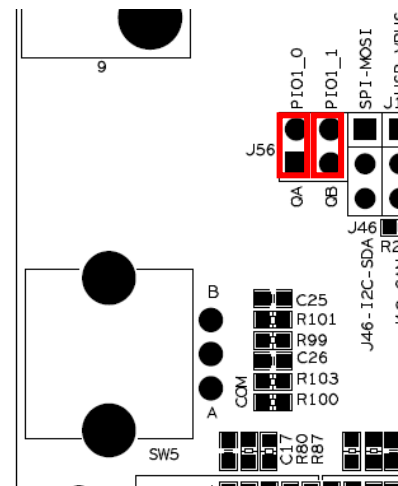

Figure 44 – Jumper Setting: Quadrature Rotary Switch, J56

4.6.4 Temperature Sensor – U7

The output signal from U7 (schematic page 6) can be connected to either GPIO_4 or GPIO_17. J25 selects which. See Figure 45 for jumper details.

J26 can set the TS0/TS1 configuration inputs of the temperature sensor. An inserted jumper pulls the respective signal low. The signal is high when leaving the jumper position open.

Upper pos.: U7 to GPIO_4
Lower pos.: U7 to GPIO_17

Right: J26, pin 1-2 (U7-TS0)
Left: J26, pin 3-4 (U7-TS1)

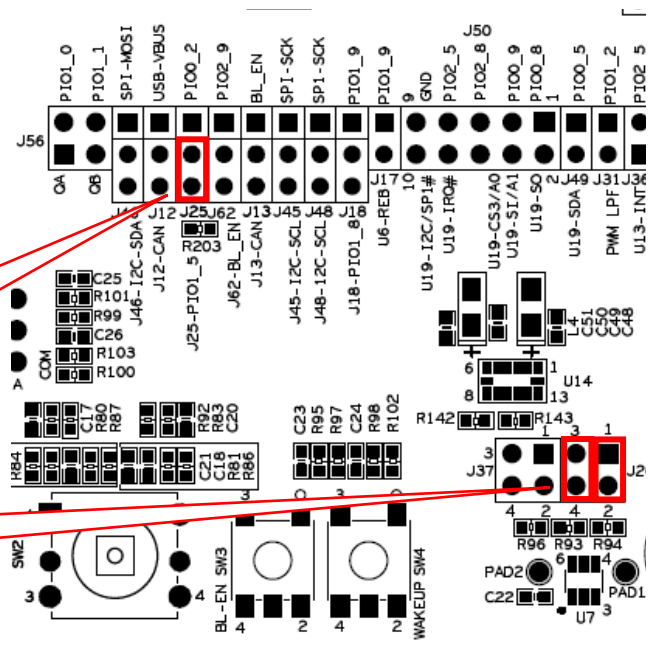

Figure 45 – Jumper Setting: Temperature sensor, U7

4.7 PWM IO

The LPC1xxx is connected to a number of peripherals directly via the general purpose digital input/output pins. These pins can also be configured as Pulse Width Modulated (PWM) output signals:

- RGB-LED, see schematic page 6, LED3. See subsection 4.7.1
- PWM Low Pass Filter to Analog Signal, see schematic page 7, U9. See subsection 4.7.2

Note that these peripherals can either be controlled by pins configured as direct digital outputs or as PWM outputs.

4.7.1 RGB-LED, LED3

Insert the three jumpers in J23 (schematic page 6), as illustrated in Figure 46. GPIO_28 controls the red LED. GPIO_14 controls the blue LED. GPIO_29 controls the green LED.

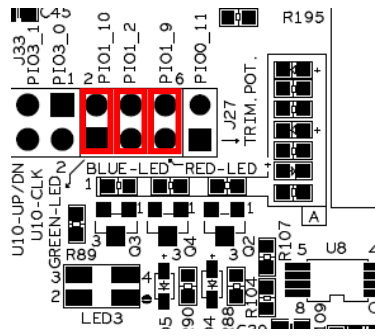

Figure 46 – Jumper Setting: RGB-LED, LED3

4.7.2 PWM Low Pass Filter to Analog Signal, U9

Insert a jumper in J31 to connect signal GPIO_14 to the low pass filter implemented around U9. The PWM input signal and the low pass filtered result are available on pads. See Figure 47 for details.

The low pass filtered signal, which is an analog signal (as opposed to the digital PWM signal) can be connected to an audio amplifier. See section 4.8 for details about this.

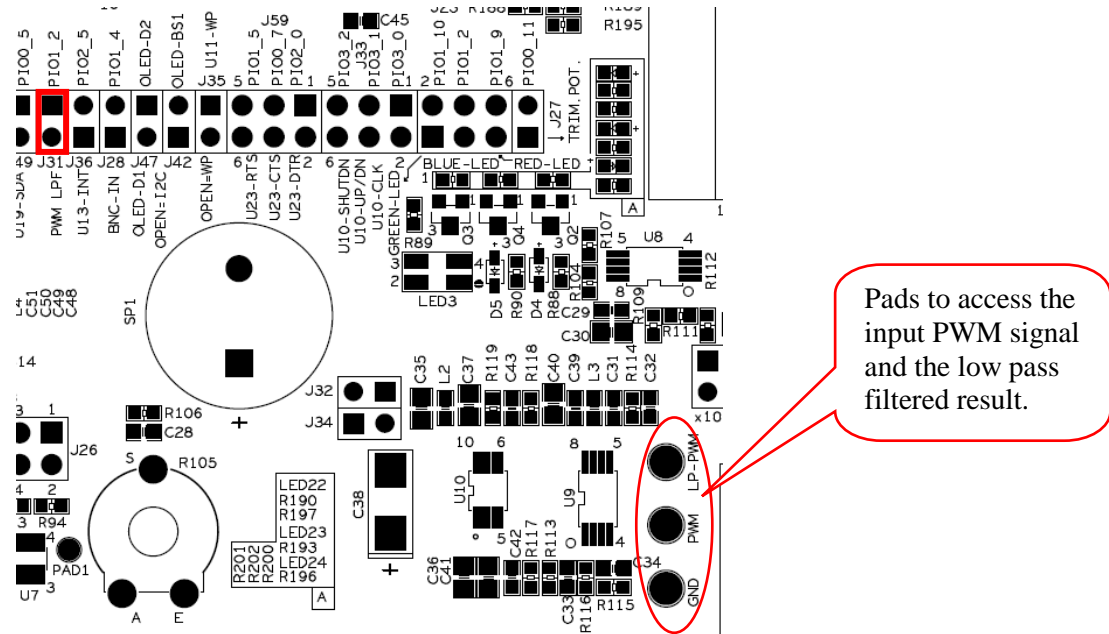

Figure 47 – Jumper Setting: PWM Low Pass Filtering, U9

4.8 Audio Amplifier

The audio amplifier is always connected to the low pass filtered signal. Insert a jumper in J32 to connect the speaker to the amplifier. The audio amplifier volume can be controlled/adjusted via three digital signals. Insert three jumpers in J33 to connect GPIO_21, GPIO_22 and GPIO_23 to control the amplifier. See Figure 48 for details.

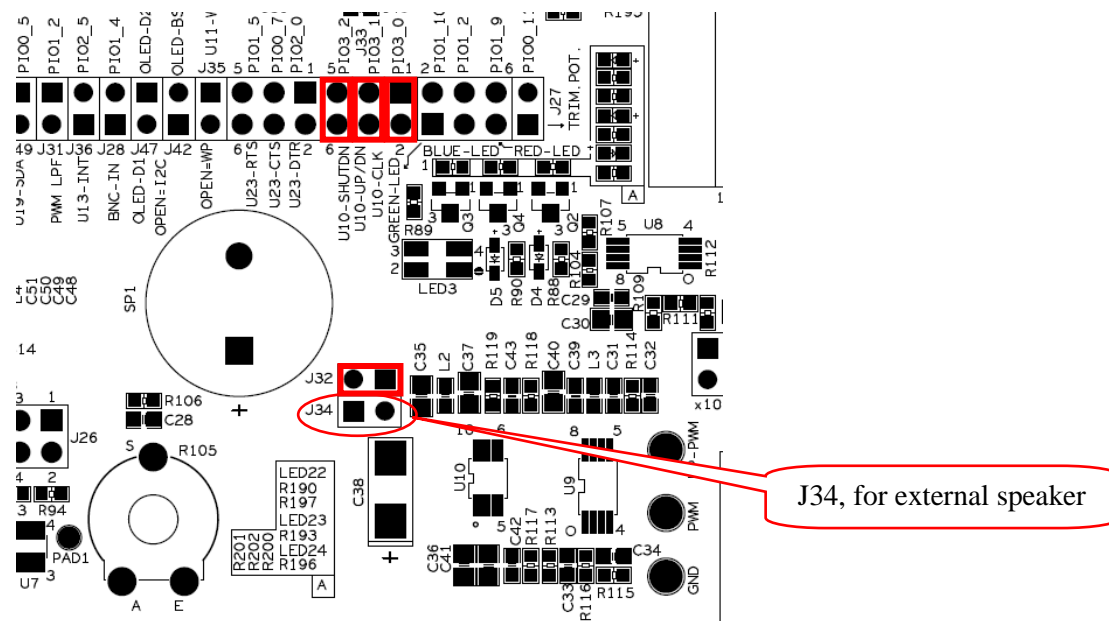

Figure 48 – Jumper Setting: Audio Amplifier, U10

4.9 Direct Analog IO

The LPC1xxx is connected to a number of peripherals directly via analog input pins:

- Trimming potentiometer (R105), see schematic page 7. See subsection 4.9.1
- BNC input (X2 and U8), see schematic page 7. See subsection 4.9.2

4.9.1 Trimming Potentiometer – R105

Insert jumper in J27 to connect the analog signal from the trimming potentiometer to GPIO_11, which is an analog input of the LPC1xxx. See Figure 49 for details.

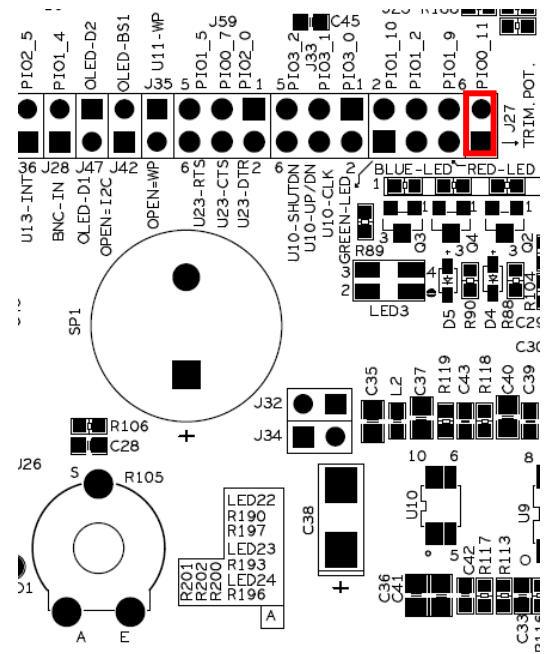

Figure 49 – Jumper Setting: trimming Potentiometer R105

4.9.2 BNC Analog Input, X2 and U8

X2 is a BNC connector and U8 implements a simple input stage that can be DC or AC coupled. There is also an option to have x10 amplification. It is possible to connect an oscilloscope probe to X2.

Insert a jumper in J28 to connect the analog signal to GPIO_16-WAKEUP. Select DC or AC coupling with J29 and J57. Note that J29/J57 shall always be set in the same position (left or right). Insert a jumper in J30 to get x10 amplification. No jumper in J30 results in x1 amplification. See Figure 50 for details.

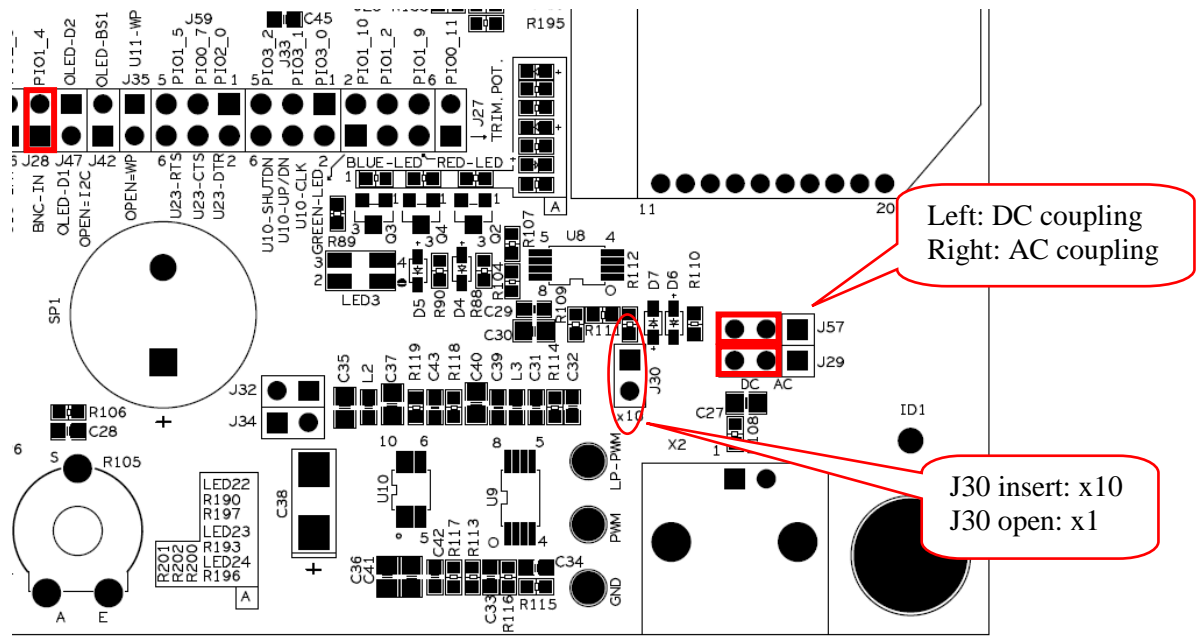

Figure 50 – Jumper Setting: BNC analog input, U8

4.10 LPC176x and mbed: USB Host, CAN and Ethernet

There are three peripherals that are only valid for the LPC176x and mbed module:

- USB Host (J60), see schematic page 5. See subsection 4.10.1
- CAN (U4), see schematic page 5. See subsection 4.10.2
- Ethernet connector (J19), see schematic page 5. See subsection 4.10.3

4.10.1 USB Host – J60/J61

The LPC176x and mbed module have USB Host functionality. On rev B of the *LPCXpresso Base Board* a USB Host interface has been added. Insert all three jumpers in J61. See Figure 51 for details.

Note that the USB Device interface (X1 connector) cannot be used at the same time as the USB Host functionality.

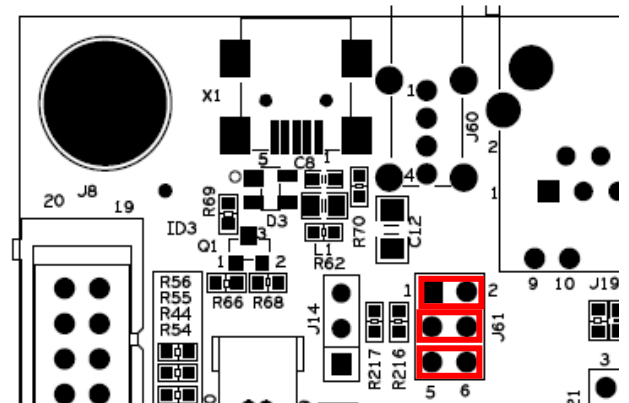

Figure 51 – Jumper Setting: USB Host, J60/J61

4.10.2 CAN – U4

The LPC176x and the mbed module has a microcontroller that has a built-in CAN controlled peripheral. U4 (TJA1040) is an external CAN transceiver, see schematic page 5.

Insert jumpers in J12, pin 2-3 and J13, pin 2-3 to connect the CAN transceiver to the LPC176x/mbed module. See Figure 52 for details.

Note that even though the other LPC1xxx processors do not have a built-in CAN controlled it is possible to create a CAN controlled in software (at least for low bit rates).

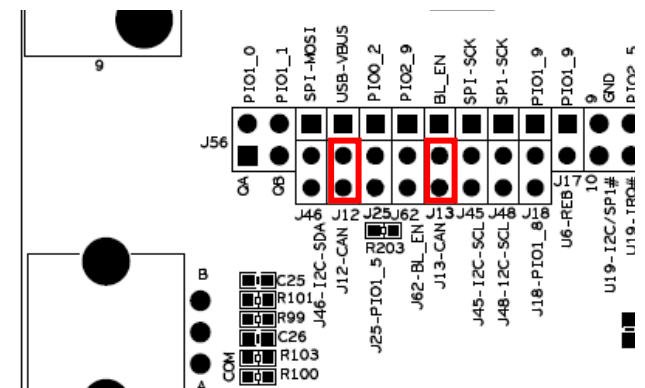

Figure 52 – Jumper Setting: CAN, U4

4.10.3 Ethernet – J19

The Ethernet connector (J19, schematic page 5) is connected to the socket for the LPC176x/mbed module. The Ethernet PHY is on the LPCXpresso LPC176x/mbed module.

There are two LEDs inside the J19. Note that the LEDs are not controlled by the Ethernet PHY. They have to be controlled by software. See Figure 53 for details about J21.

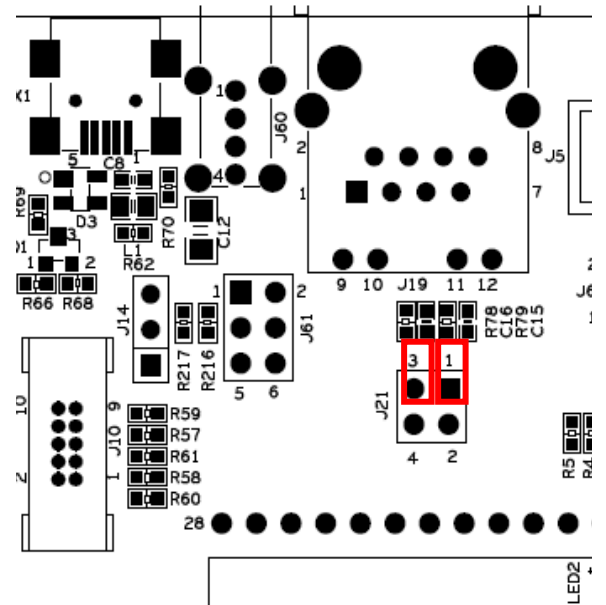

Figure 53 – Jumper Setting: Ethernet Connector, J19

5.1 Expansion Connectors

All LPC1xxx pins, except the USB and Ethernet signals, are available together with power on two expansion connectors (see schematic page 3). There is a male (J5) and a female (J6) 50-position connector. See Figure 54 for details. Picture below show rev A of the board but rev B is exactly the same for J5 and J6.

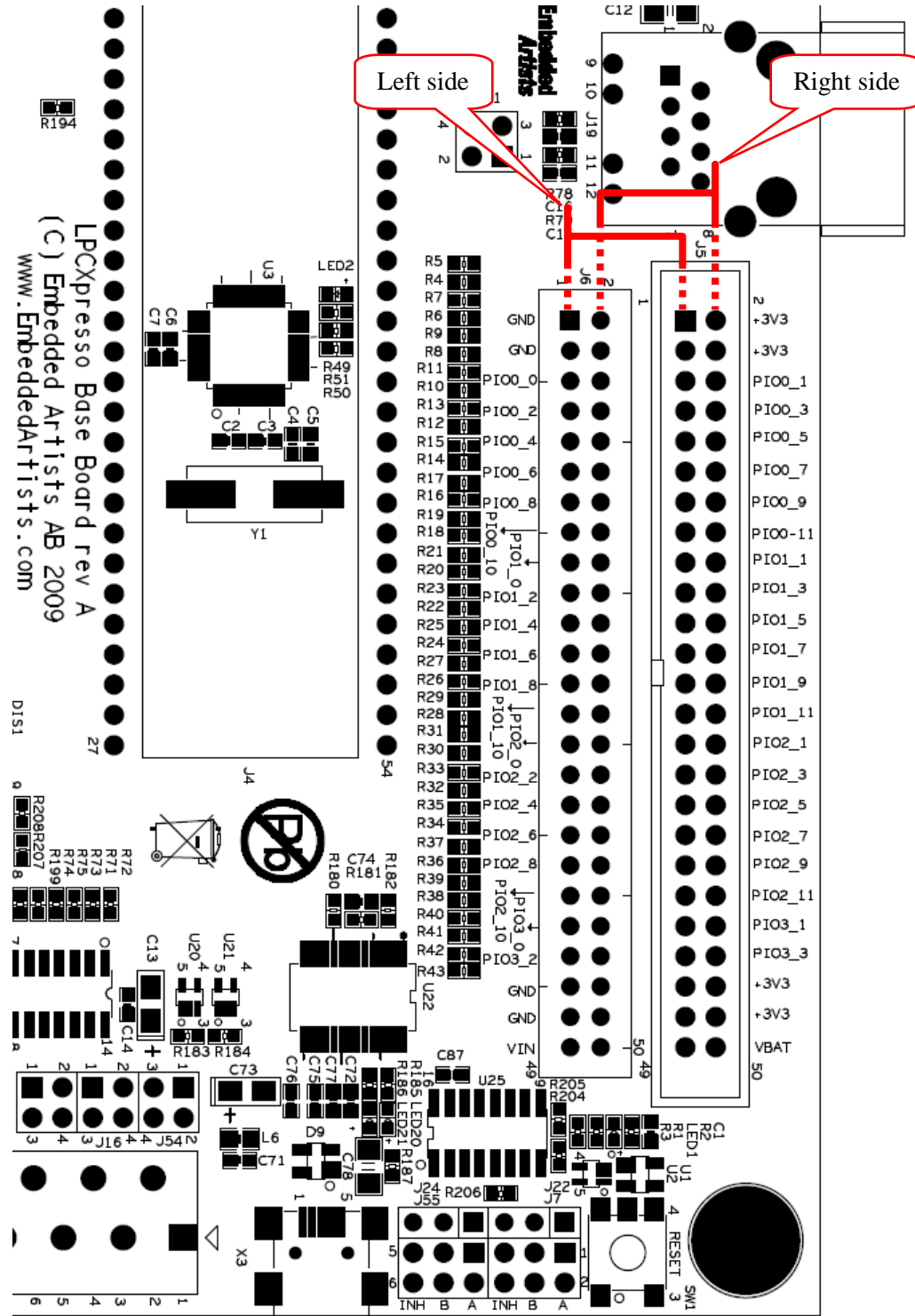

Figure 54 – LPCXpresso Base Board Expansion Connectors (J5, J6)

The text on the pcb indicates where the different signals can be accessed. The left side of J6 is also valid as a left side of J5, and similar is the right side of J5 also valid as right side of J6.

Note that the pin names/text is valid for the LPC1343 (for which the *LPCXpresso Base Board* was originally designed). Gradually more and more LPCXpresso target boards have been added and signal names on the schematic have changed to generic names. Be sure to understand the connection between the two naming conventions.

All PIO-pins have 270 ohm series resistors to provide some protection for short circuits and to some extent also ESD.

Note that the current to external circuits are not limited. Keep power consumption below 50mA if powered only via the *LPCXpresso Board* (via the USB connector for LPC-LINK) or below 250mA if powered via the USB-to-UART bridge on the *LPCXpresso Base Board* (connector X3, schematic page 11).

The male expansion connector (J5) can use a standard 50 position IDC flat cable to interface to an external design. The female expansion connector (J6) can be used to interface breadboard designs via simple wire jumpers.

6 mbed and LPC1xxx Differences

There are small but important differences between the mbed module and the *LPCXpresso boards*, and there are also small differences between the different *LPCXpresso boards*. This chapter explains the differences.

Note that the signal names printed in the PCB of the *LPCXpresso Base Board* follow the LPC1343 board since this was the first one created. The signal names in the schematic have changed to more generic GPIO_XX names when more LPCXpresso target boards were developed.

See chapter 5 for pin usage with the generic signal names. There is an Excel sheet on the support site that contains information about all different LPCXpresso target boards and the pin connections.

6.1 mbed

This document describes the *LPCXpresso Base Board* from the perspective of connecting it to *LPCXpresso boards* with LPC1xxx processors. The board is however also designed for the mbed module.

The *LPCXpresso boards* are in many ways compatible with the mbed module.

- Mechanically they have the same format, except that the *LPCXpresso boards* have more pins at one end of the board.
- Most pins can have the same functionality, like UART, I2C, SPI, analog input, etc.

Figure 55 illustrates how the mbed is mounted on the *LPCXpresso Base Board*. It shall be placed on the upper most position in J4 when the base board is oriented as in the picture below.

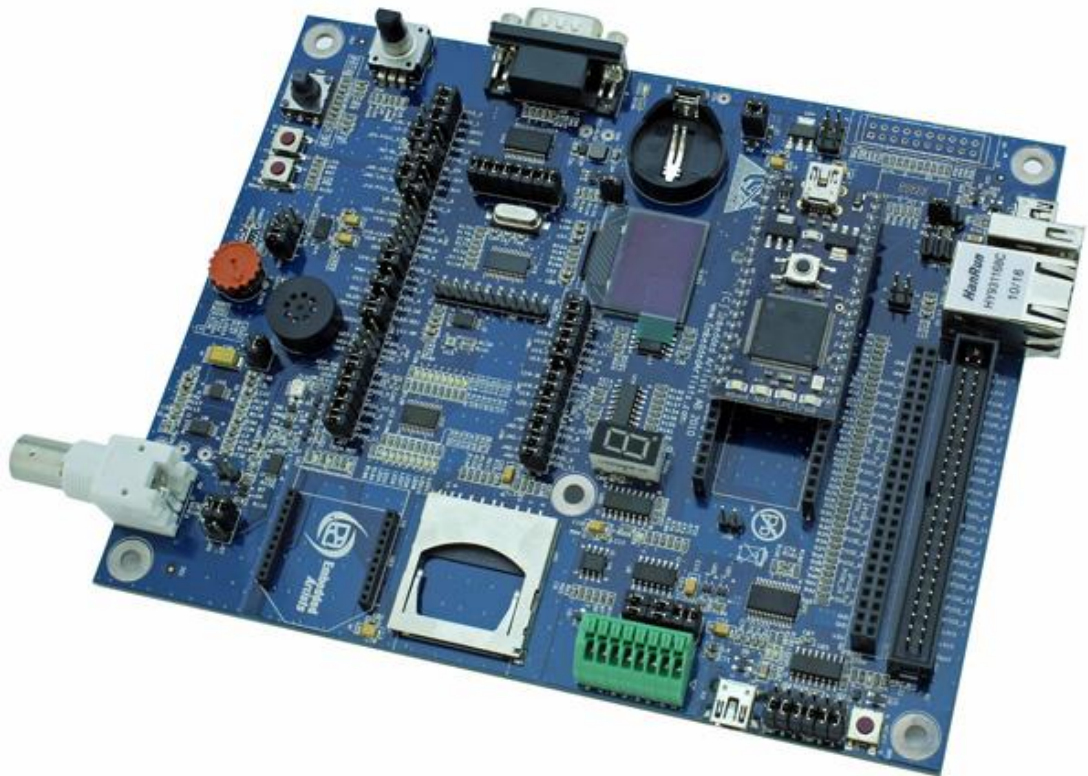

Figure 55 – mbed module mounted on LPCXpresso Base Board

The mbed module has a powerful processor that has built-in peripherals for USB Host, CAN and Ethernet. The *LPCXpresso Base Board* has special support for this in the form of:

- USB Host connector (J60, see schematic page 5)
- CAN transceiver (U4, see schematic page 5)
- Ethernet connector (J19, see schematic page 5)

The following limitations apply to the mbed module:

- Cannot control the audio amplifier (U10). Lack signals GPIO_21, GPIO_22, GPIO_23.
- No card detect signal from SD/MMC memory card interface. Lack signal GPIO_38.
- J58 must be inserted when accessing the OLED in SPI mode. This is because the signal GPIO_35 is not available on the mbed module (the signal is used as D/C input signal for the display). Insert J58 and signal GPIO_2-MISO can be used for control. Note that signal naming above follow LPCXpresso base board naming, which is not the same naming as the mbed module has. See Figure 56 for details where to find J58.
- Dual UART (SC16IS752) must be interfaced via I2C (not SPI). Lack GPIO_36, which is used as SPI-SSEL for the chip.
- Lack GPIO_17: used as RTS for RF-module (U23), also used for temperature alternative 1 output (U7).
- Lack GPIO_18: used as TX_EN for RS422 (U6) (can however use GPIO_28 to drive both TX_EN and RX_EN#), also used for irq2 output from accelerometer (U14).

Note that if the design have unused pins these can be connected to the missing ones (listed above). Such connections must be manually soldered.

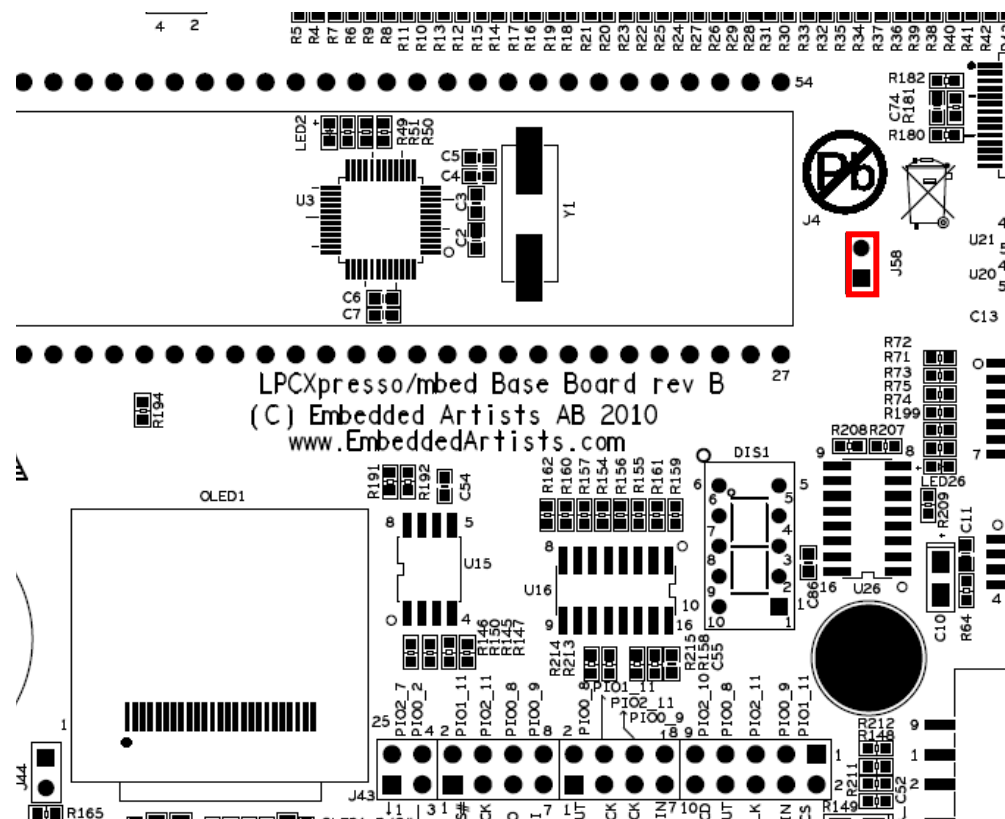

Figure 56 – Jumper Setting, J58: OLED Control for mbed

See chapter 5 for pin usage of the mbed module.

6.2 LPCXpresso LPC11C24

The LPC11C24 has fewer available GPIO pins since the on-chip CAN transceiver requires some pins. There is an Excel sheet that can be downloaded with the pinning of all LPCXpresso modules. This together with the table in the beginning of chapter 5 gives the differences (compared to the LPCXpresso LPC1114 Board) that must be considered when using the LPCXpresso LPC11C24 Board:

- Pin 42: Is P1.9 on LPC1114 but P3.3 on LPC11C24. This affects control of the red LED in the RGB-LED.
- Pin 46: Is P2.4 on LPC1114 but P2.6 on LPC11C24. This affects how to detect the joystick down key.
- Pin 47: Is P2.5 on LPC1114 but not connected on LPC11C24. This has affect in the irq signal on the base board.
- Pin 48: Is P2.6 on LPC1114 but not connected on LPC11C24.
- Pin 51: Is P2.9 on LPC1114 but not connected on LPC11C24.
- Pin 53: Is P3.3 on LPC1114 but not connected on LPC11C24. P3.3 is connected to pin 42.

6.3 LPCXpresso LPC176x

6.3.1 GPIO_21/22 needs pull-up resistors

The LPC176x cannot control the signals GPIO_21 and GPIO_22 since these signals connect to P0.27 and P0.28 respectively. These are open drain pins and need pull-up resistors to be able to output a high signal level. This means that it is impossible to adjust the LPC4811 volume (since the GPIO_21/22 pins will be constantly low). In order for this to work, simply add pull-up resistors to each of these pins. 5K-10K ohm is a suitable value on the resistors.

6.3.2 ISP mode UART availability

When setting the LPC176x in ISP mode, J62 shall not be in the default position. See section 4.6.1 for details about setting. **Note however that even though it is possible to set the LPC176x in ISP mode it is not possible to download a program image without an external adapter (not included) that connects to UART#0.**

6.3.3 Analog input filtering

It is recommended to add filtering capacitors on the analog inputs, in the 100nF to 1uF range. The LPCXpresso target boards are build on 2-layer pcb:s and from a noise and grounding perspective, the layout is not optimal. Adding filtering capacitors (and low-pass filters in general) on the analog signals will improve accuracy and reduce noise in the ADC conversion.

7 Mechanical Dimensions

Figure 57 below contains a drawing of the board that includes mechanical measures. Important holes or center lines are marked with x,y coordinates in mil and mm.

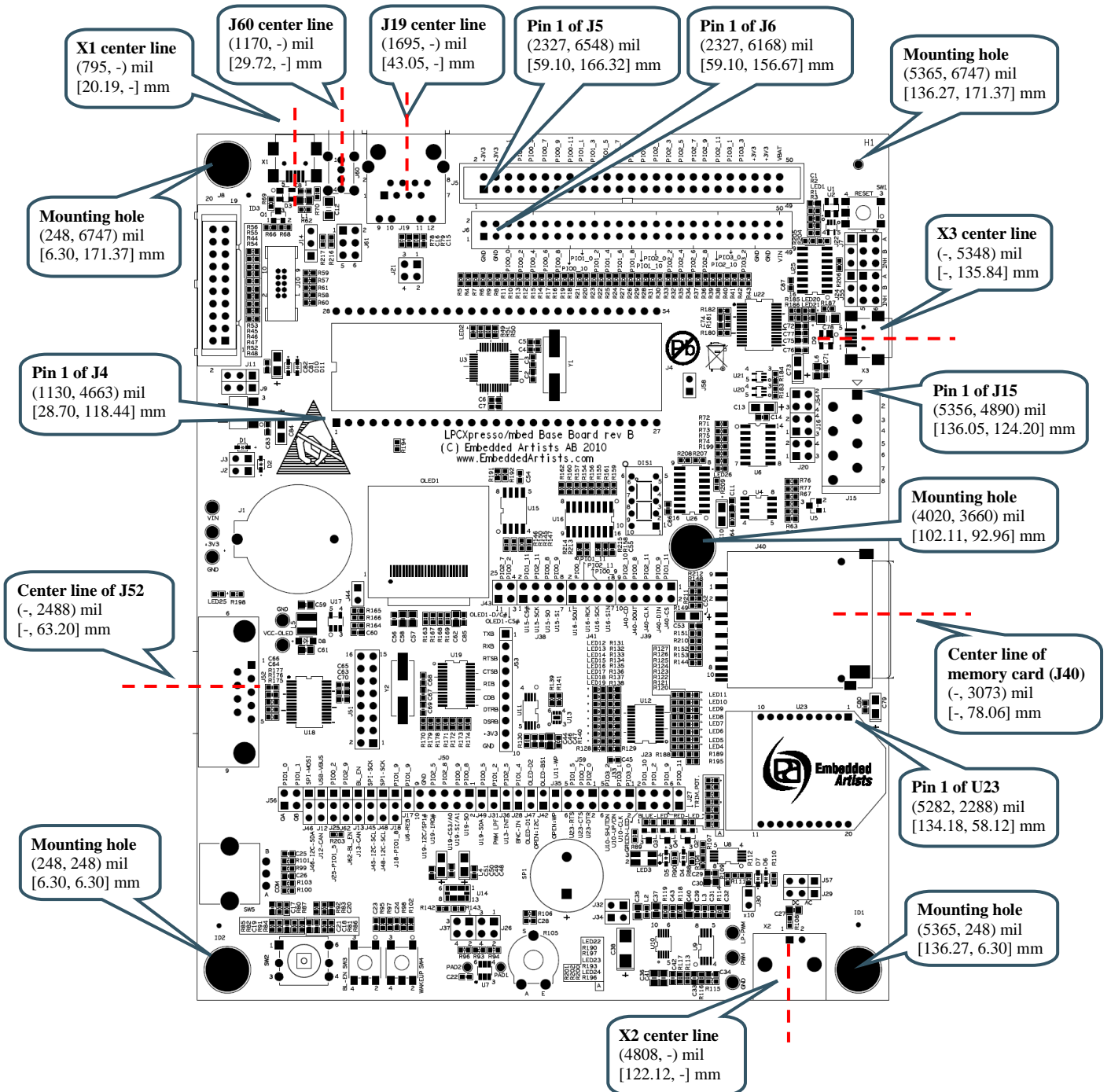

Figure 57 – LPCXpresso Base Board Mechanical Dimensions

8 Troubleshooting

8.1 The Board is Always in Reset

Reason 1: If a terminal application, such as Tera Term, is connected to the COM port associated with the board and at the same time have the J54 jumpers (see Figure 21) inserted, the terminal application might be the cause of this problem. If the terminal application is pulling DTR low the board will be reset and if it pulls RTS low it will control the bootloader enable functionality.

Solution 1: Remove the jumpers and try again (please note that the jumpers must be inserted if the board is programmed using the UART boot mode).

Reason 2: If the board is powered only through the USB interface on the LPCXpresso LPC1xxx Board (interface 2 as shown in Figure 3) the FTDI USB-to-UART bridge won't be powered. The output pins such as RTS and CTS might then have a low output. If the J54 jumpers, see Figure 21, are inserted the board will always be in reset.

Solution 2: Power the board also through USB interface #1, as shown in Figure 3, or remove the J54 jumpers.

8.2 The Board Behaves Strange

The *LPCXpresso Base Board* shall be powered from a PC via the included USB cable (mini-B to A cable). Up to 500mA can be drawn from the USB port.

Reason: The *LPCXpresso Base Board* and *LPCXpresso LPC1xxx Board* do not receive enough current. Symptoms when insufficient power is supplied can exhibit itself in a number of ways; the *board may appear to work*, but:

- you may fail to program the Flash on the device (as more power is drawn), or
- the debugger may not be able to find the target, or
- the debugger may disconnect unexpectedly, or
- a variety of other inexplicable errors!

Solution 1: Make sure the main power source is the USB-to-UART bridge. See Figure 3.

Solution 2: Not all PC USB ports supply the specified top current (500 mA). This is especially true for laptops, but affects many desktop PCs too. Use a powered USB hub to power the *LPCXpresso Base Board*.

8.3 Analog Input GPIO_11 Does Not Reach Zero

The trimming potentiometer (R105) can be used to create an analog voltage to GPIO_11 (analog input 1). The lowest possible reading can be between 20-40 (on a scale from 0 to 1023) even if the trimming potentiometer is turned to the lowest output voltage.

Reason: There are pull-up resistors on GPIO_11 that will generate a current through R106. One pull-up resistor is internal in the LPC1xxx and can be disabled via program control. The other pull-up resistor is R46 (via R57), found on schematic page 4. These resistors are actually mounted even though the schematic indicate that this is an optional mounting. The voltage across R106 can be up to about 0.1 volt due to the pull-up resistors on GPIO_11.

Solution: Make sure that GPIO_11 does not have the (LPC1xxx) internal pull-up resistor enabled. This is a pin configuration. Also remove R57 or R46. Either of these resistors can easily be de-soldered from the pcb.

9 Further Information

The LPC1xxx microcontrollers are complex circuits and there are a number of other documents with more information. The following documents are recommended as a complement to this document.

- [1] NXP LPC1xxx Datasheets, User's Manuals and Erratas
<http://ics.nxp.com/products/lpc1000/all/>
- [2] LPC1000 Yahoo Group. A discussion forum dedicated entirely to the NXP LPC1xxx series of microcontrollers.
<http://groups.yahoo.com/group/lpc1000/>
- [3] LPC2000 Yahoo Group. A discussion forum dedicated entirely to the NXP LPC2xxx series of microcontrollers.
<http://groups.yahoo.com/group/lpc2000/>

Note that there can be newer versions of the documents than the ones linked to here. Always check for the latest information / version.