



Is Now Part of



**ON Semiconductor®**

To learn more about ON Semiconductor, please visit our website at  
[www.onsemi.com](http://www.onsemi.com)

ON Semiconductor and the ON Semiconductor logo are trademarks of Semiconductor Components Industries, LLC dba ON Semiconductor or its subsidiaries in the United States and/or other countries. ON Semiconductor owns the rights to a number of patents, trademarks, copyrights, trade secrets, and other intellectual property. A listing of ON Semiconductor's product/patent coverage may be accessed at [www.onsemi.com/site/pdf/Patent-Marking.pdf](http://www.onsemi.com/site/pdf/Patent-Marking.pdf). ON Semiconductor reserves the right to make changes without further notice to any products herein. ON Semiconductor makes no warranty, representation or guarantee regarding the suitability of its products for any particular purpose, nor does ON Semiconductor assume any liability arising out of the application or use of any product or circuit, and specifically disclaims any and all liability, including without limitation special, consequential or incidental damages. Buyer is responsible for its products and applications using ON Semiconductor products, including compliance with all laws, regulations and safety requirements or standards, regardless of any support or applications information provided by ON Semiconductor. "Typical" parameters which may be provided in ON Semiconductor data sheets and/or specifications can and do vary in different applications and actual performance may vary over time. All operating parameters, including "Typicals" must be validated for each customer application by customer's technical experts. ON Semiconductor does not convey any license under its patent rights nor the rights of others. ON Semiconductor products are not designed, intended, or authorized for use as a critical component in life support systems or any FDA Class 3 medical devices or medical devices with a same or similar classification in a foreign jurisdiction or any devices intended for implantation in the human body. Should Buyer purchase or use ON Semiconductor products for any such unintended or unauthorized application, Buyer shall indemnify and hold ON Semiconductor and its officers, employees, subsidiaries, affiliates, and distributors harmless against all claims, costs, damages, and expenses, and reasonable attorney fees arising out of, directly or indirectly, any claim of personal injury or death associated with such unintended or unauthorized use, even if such claim alleges that ON Semiconductor was negligent regarding the design or manufacture of the part. ON Semiconductor is an Equal Opportunity/Affirmative Action Employer. This literature is subject to all applicable copyright laws and is not for resale in any manner.



# FDI9409\_F085

## N-Channel PowerTrench<sup>®</sup> MOSFET

40 V, 80 A, 3.8 mΩ



### Features

- Typical  $R_{DS(on)}$  = 2.9 mΩ at  $V_{GS} = 10V$ ,  $I_D = 80 A$
- Typical  $Q_{g(tot)}$  = 43 nC at  $V_{GS} = 10V$ ,  $I_D = 80 A$
- UIS Capability
- RoHS Compliant
- Qualified to AEC Q101

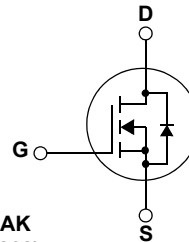
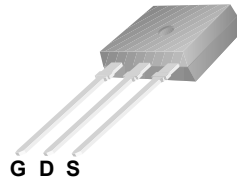

I<sup>2</sup>-PAK (TO-262)

### Applications

- Automotive Engine Control
- PowerTrain Management
- Solenoid and Motor Drivers
- Integrated Starter/Alternator
- Primary Switch for 12V Systems



For current package drawing, please refer to the Fairchild website at <https://www.fairchildsemi.com/package-drawings/TO/TO262A03.pdf>

### MOSFET Maximum Ratings $T_J = 25^\circ C$ unless otherwise noted.

| Symbol          | Parameter  | Rated        | Units |
|-----------------|--|--------------|-------|
| $V_{DSS}$       | Drain-to-Source Voltage                                  | 40           | V     |
| $V_{GS}$        | Gate-to-Source Voltage                                   | ±20          | V     |
| $I_D$           | Drain Current - Continuous ( $V_{GS}=10$ ) (Note 1)      | 80           | A     |
|                 | Pulsed Drain Current                                     | See Figure 4 |       |
| $E_{AS}$        | Single Pulse Avalanche Energy (Note 2)                   | 70           | mJ    |
| $P_D$           | Power Dissipation  | 94           | W     |
|                 | Derate Above 25°C  | 0.63         | W/°C  |
| $T_J, T_{STG}$  | Operating and Storage Temperature                        | -55 to + 175 | °C    |
| $R_{\theta JC}$ | Thermal Resistance, Junction to Case                     | 1.6          | °C/W  |
| $R_{\theta JA}$ | Maximum Thermal Resistance, Junction to Ambient (Note 3) | 43           | °C/W  |

#### Notes:

- 1: Current is limited by bondwire configuration.
- 2: Starting  $T_J = 25^\circ C$ ,  $L = 34\mu H$ ,  $I_{AS} = 64A$ ,  $V_{DD} = 40V$  during inductor charging and  $V_{DD} = 0V$  during time in avalanche.
- 3:  $R_{\theta JA}$  is the sum of the junction-to-case and case-to-ambient thermal resistance, where the case thermal reference is defined as the solder mounting surface of the drain pins.  $R_{\theta JC}$  is guaranteed by design, while  $R_{\theta JA}$  is determined by the board design. The maximum rating presented here is based on mounting on a 1 in<sup>2</sup> pad of 2oz copper.

### Package Marking and Ordering Information

| Device Marking | Device       | Package | Reel Size | Tape Width | Quantity |
|----------------|--------------|---------|-----------|------------|----------|
| FDI9409        | FDI9409_F085 | TO-262  | Tube      | N/A        | 50 units |

FDI9409\_F085 N-Channel PowerTrench<sup>®</sup> MOSFET

**Electrical Characteristics**  $T_J = 25^\circ\text{C}$  unless otherwise noted.

| Symbol | Parameter | Test Conditions | Min. | Typ. | Max. | Units |
|--------|-----------|-----------------|------|------|------|-------|
|--------|-----------|-----------------|------|------|------|-------|

**Off Characteristics**

|              |                                   |  |    |   |           |               |
|--------------|-----------------------------------|--|----|---|-----------|---------------|
| $B_{V_{DS}}$ | Drain-to-Source Breakdown Voltage | $I_D = 250\mu\text{A}, V_{GS} = 0\text{V}$             | 40 | - | -         | V             |
| $I_{DSS}$    | Drain-to-Source Leakage Current   | $V_{DS} = 40\text{V}, T_J = 25^\circ\text{C}$          | -  | - | 1         | $\mu\text{A}$ |
|              |                                   | $V_{GS} = 0\text{V}, T_J = 175^\circ\text{C}$ (Note 4) | -  | - | 1         | mA            |
| $I_{GSS}$    | Gate-to-Source Leakage Current    | $V_{GS} = \pm 20\text{V}$                              | -  | - | $\pm 100$ | nA            |

**On Characteristics**

|              |                                  |   |     |     |     |            |
|--------------|----------------------------------|---|-----|-----|-----|------------|
| $V_{GS(th)}$ | Gate to Source Threshold Voltage | $V_{GS} = V_{DS}, I_D = 250\mu\text{A}$                 | 2.0 | 3.0 | 4.0 | V          |
| $R_{DS(on)}$ | Drain to Source On Resistance    | $I_D = 80\text{A}, T_J = 25^\circ\text{C}$              | -   | 2.9 | 3.8 | m $\Omega$ |
|              |                                  | $V_{GS} = 10\text{V}, T_J = 175^\circ\text{C}$ (Note 4) | -   | 4.9 | 6.4 | m $\Omega$ |

**Dynamic Characteristics**

|              |                               |  |   |      |    |          |
|--------------|-------------------------------|--|---|------|----|----------|
| $C_{iss}$    | Input Capacitance             | $V_{DS} = 25\text{V}, V_{GS} = 0\text{V}, f = 1\text{MHz}$ | - | 2980 | -  | pF       |
| $C_{oss}$    | Output Capacitance            |  | - | 788  | -  | pF       |
| $C_{rSS}$    | Reverse Transfer Capacitance  |  | - | 45   | -  | pF       |
| $R_g$        | Gate Resistance               | $f = 1\text{MHz}$  | - | 2.2  | -  | $\Omega$ |
| $Q_{g(ToT)}$ | Total Gate Charge at 10V      | $V_{GS} = 0$ to 10V  | - | 43   | 56 | nC       |
| $Q_{g(th)}$  | Threshold Gate Charge         | $V_{GS} = 0$ to 2V   |   |      |    |          |
| $Q_{gs}$     | Gate-to-Source Gate Charge    | $V_{DD} = 32\text{V}, I_D = 80\text{A}$                    | - | 15.5 | -  | nC       |
| $Q_{gd}$     | Gate-to-Drain "Miller" Charge |  | - | 10   | -  | nC       |

**Switching Characteristics**

|              |                |   |   |    |     |    |
|--------------|----------------|---|---|----|-----|----|
| $t_{on}$     | Turn-On Time   | $V_{DD} = 20\text{V}, I_D = 80\text{A}, V_{GS} = 10\text{V}, R_{GEN} = 6\Omega$ | - | -  | 193 | ns |
| $t_{d(on)}$  | Turn-On Delay  |   | - | 17 | -   | ns |
| $t_r$        | Rise Time      |   | - | 90 | -   | ns |
| $t_{d(off)}$ | Turn-Off Delay |   | - | 24 | -   | ns |
| $t_f$        | Fall Time      |   | - | 10 | -   | ns |
| $t_{off}$    | Turn-Off Time  |   | - | -  | 50  | ns |

**Drain-Source Diode Characteristics**

|          |                               |  |   |    |      |    |
|----------|-------------------------------|--|---|----|------|----|
| $V_{SD}$ | Source-to-Drain Diode Voltage | $I_{SD} = 80\text{A}, V_{GS} = 0\text{V}$                | - | -  | 1.25 | V  |
|          |                               | $I_{SD} = 40\text{A}, V_{GS} = 0\text{V}$                | - | -  | 1.2  | V  |
| $t_{rr}$ | Reverse-Recovery Time         | $I_F = 80\text{A}, dI_{SD}/dt = 100\text{A}/\mu\text{s}$ | - | 54 | 71   | ns |
| $Q_{rr}$ | Reverse-Recovery Charge       | $V_{DD} = 32\text{V}$                                    | - | 47 | 62   | nC |

**Note:**

 4: The maximum value is specified by design at  $T_J = 175^\circ\text{C}$ . Product is not tested to this condition in production.

### Typical Characteristics

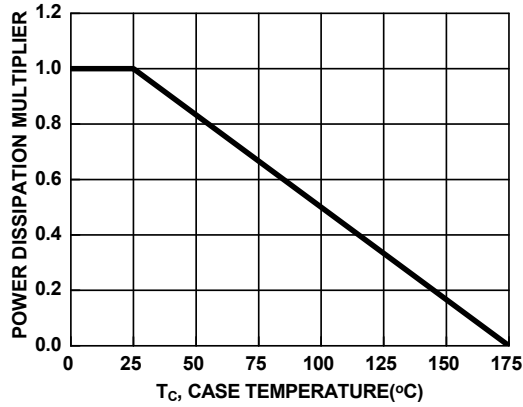

Figure 1. Normalized Power Dissipation vs. Case Temperature

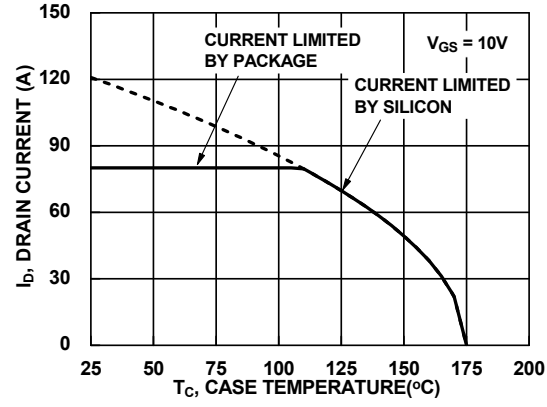

Figure 2. Maximum Continuous Drain Current vs. Case Temperature

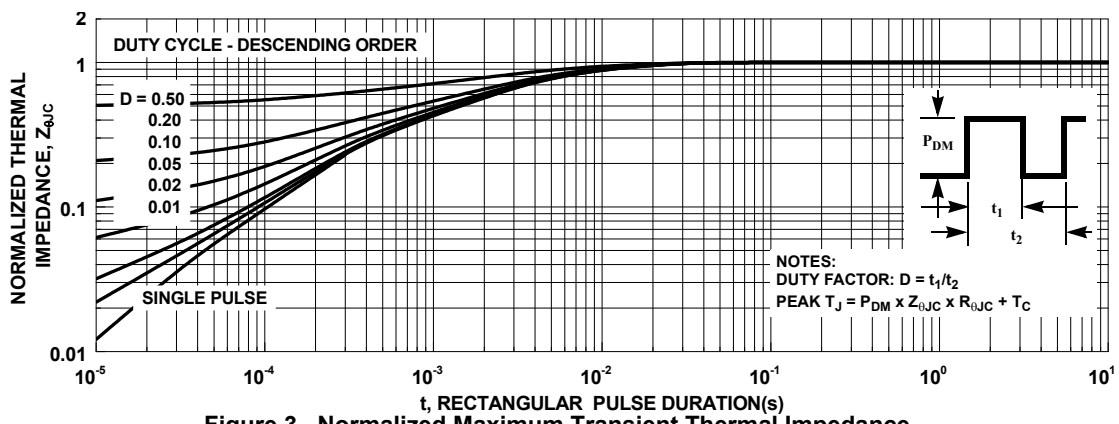

Figure 3. Normalized Maximum Transient Thermal Impedance

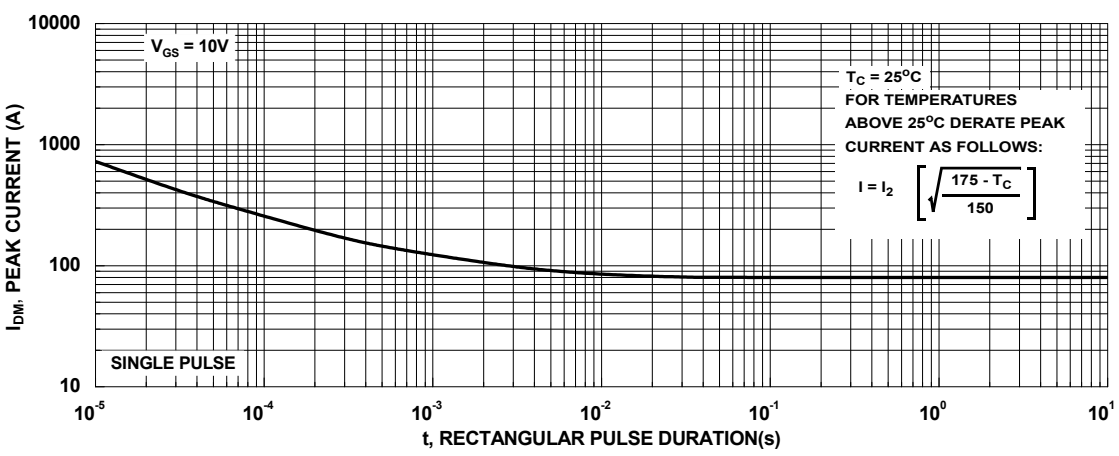

Figure 4. Peak Current Capability

## Typical Characteristics

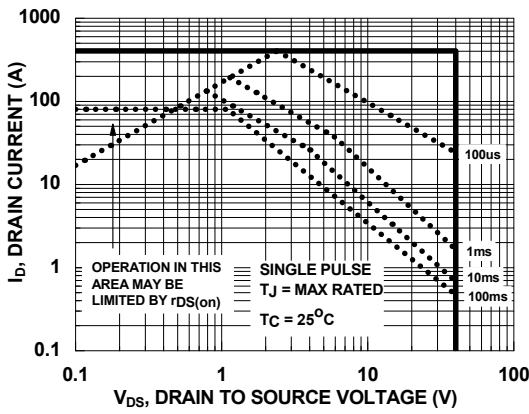
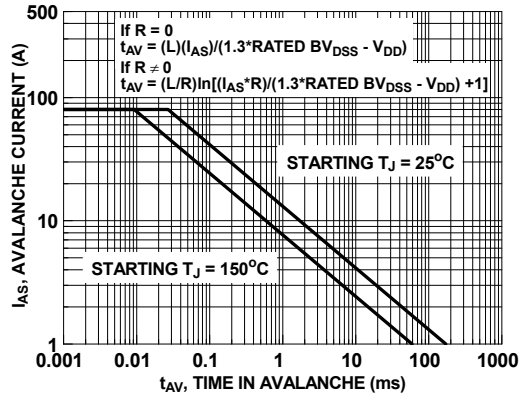

Figure 5. Forward Bias Safe Operating Area



NOTE: Refer to Fairchild Application Notes AN7514 and AN7515

Figure 6. Unclamped Inductive Switching Capability

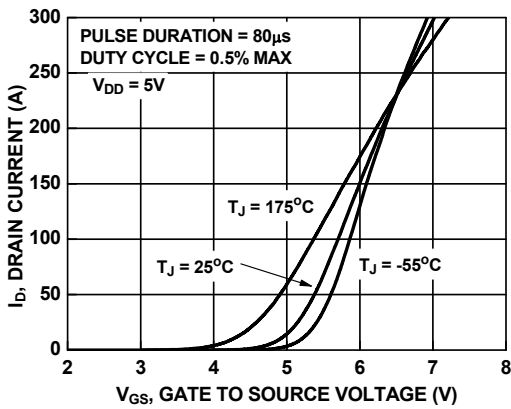

Figure 7. Transfer Characteristics

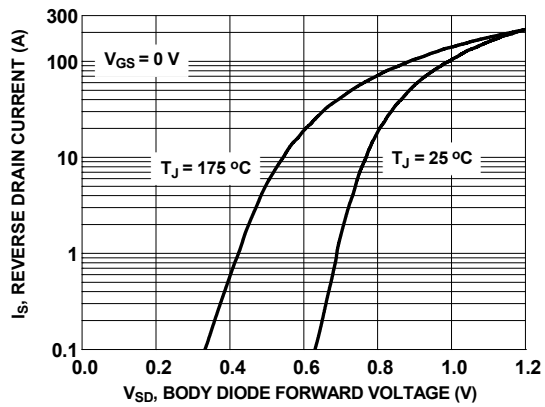

Figure 8. Forward Diode Characteristics

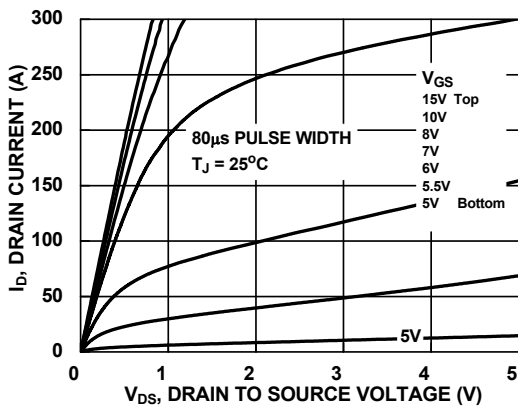

Figure 9. Saturation Characteristics

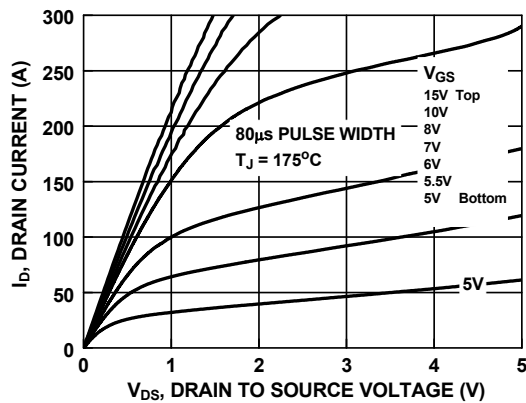

Figure 10. Saturation Characteristics

## Typical Characteristics

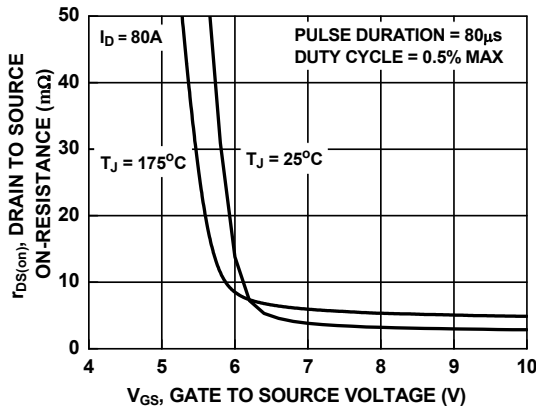

Figure 11.  $R_{DS(on)}$  vs. Gate Voltage

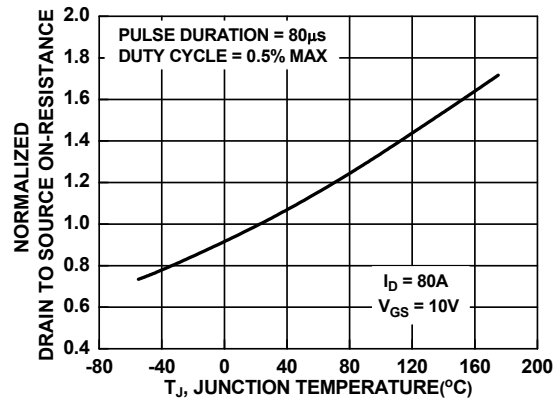

Figure 12. Normalized  $R_{DS(on)}$  vs. Junction Temperature

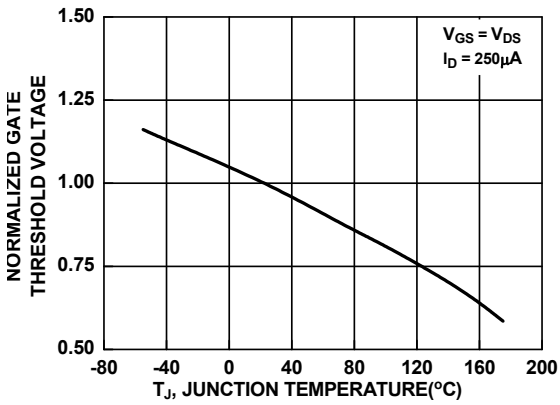

Figure 13. Normalized Gate Threshold Voltage vs. Temperature

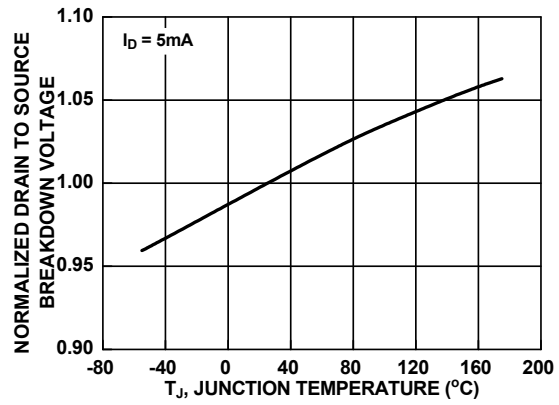

Figure 14. Normalized Drain to Source Breakdown Voltage vs. Junction Temperature

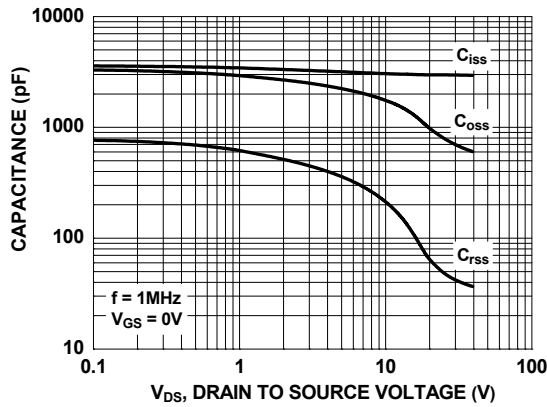

Figure 15. Capacitance vs. Drain to Source Voltage

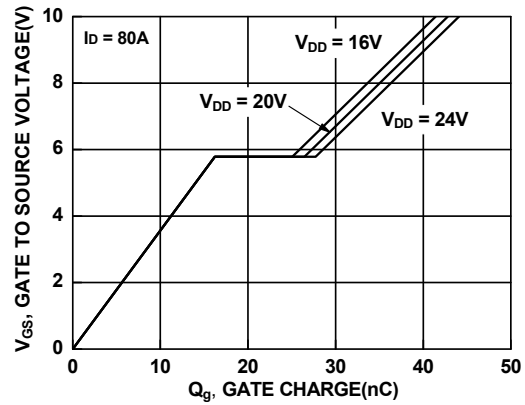







Figure 16. Gate Charge vs. Gate to Source Voltage



**TRADEMARKS**

The following includes registered and unregistered trademarks and service marks, owned by Fairchild Semiconductor and/or its global subsidiaries, and is not intended to be an exhaustive list of all such trademarks.

- |  |   |   |   |
|--|---|---|---|
| AccuPower™   | F-PFS™  |  ™ |  SYSTEM® |
| Awinda®  | FRFET®  | PowerTrench®  | TinyBoost®  |
| AX-CAP®*   | Global Power ResourceSM                         | PowerXS™  | TinyBuck®   |
| BitSiC™  | GreenBridge™                                    | Programmable Active Droop™  | TinyCalc™   |
| Build it Now™  | Green FPS™                                      | QFET®   | TinyLogic®  |
| CorePLUS™  | Green FPS™ e-Series™                            | QS™   | TINYOPTO™   |
| CorePOWER™   | Gmax™   | Quiet Series™   | TinyPower™  |
| CROSSVOLT™   | GTO™  | RapidConfigure™   | TinyPWM™  |
| CTL™   | IntelliMAX™                                     |  ™ | TinyWire™   |
| Current Transfer Logic™  | ISOPLANAR™                                      | Saving our world, 1mW/W/kW at a time™   | TranSiC™  |
| DEUXPEED®  | Marking Small Speakers Sound Louder and Better™ | SignalWise™   | TriFault Detect™  |
| Dual Cool™   | MegaBuck™                                       | SmartMax™   | TRUECURRENT®*   |
| EcoSPARK®  | MICROCOUPLER™                                   | SMART START™  | μSerDes™  |
| EfficientMax™  | MicroFET™                                       | Solutions for Your Success™   |  SerDes™ |
| ESBC™  | MicroPak™                                       | SPM®  | UHC®  |
|  Fairchild® | MicroPak2™                                      | STEALTH™  | Ultra FRFET™  |
| Fairchild Semiconductor®   | MillerDrive™                                    | SuperFET®   | UniFET™   |
| FACT Quiet Series™   | MotionMax™                                      | SuperSOT™-3   | VCX™  |
| FACT®  | MotionGrid®                                     | SuperSOT™-6   | VisualMax™  |
| FAST®  | MTI®  | SuperSOT™-8   | VoltagePlus™  |
| FastvCore™   | MTX®  | SupreMOS®   | XS™   |
| FETBench™  | MVN®  | SyncFET™  | Xsens™  |
| FPS™   | mWSave®   | Sync-Lock™  | 仙童™   |
|  | OptoHiT™  |   |   |

\*Trademarks of System General Corporation, used under license by Fairchild Semiconductor.

**DISCLAIMER**

FAIRCHILD SEMICONDUCTOR RESERVES THE RIGHT TO MAKE CHANGES WITHOUT FURTHER NOTICE TO ANY PRODUCTS HEREIN TO IMPROVE RELIABILITY, FUNCTION, OR DESIGN. TO OBTAIN THE LATEST, MOST UP-TO-DATE DATASHEET AND PRODUCT INFORMATION, VISIT OUR WEBSITE AT [HTTP://WWW.FAIRCHILDSEMI.COM](http://www.fairchildsemi.com). FAIRCHILD DOES NOT ASSUME ANY LIABILITY ARISING OUT OF THE APPLICATION OR USE OF ANY PRODUCT OR CIRCUIT DESCRIBED HEREIN; NEITHER DOES IT CONVEY ANY LICENSE UNDER ITS PATENT RIGHTS, NOR THE RIGHTS OF OTHERS. THESE SPECIFICATIONS DO NOT EXPAND THE TERMS OF FAIRCHILD'S WORLDWIDE TERMS AND CONDITIONS, SPECIFICALLY THE WARRANTY THEREIN, WHICH COVERS THESE PRODUCTS.

**LIFE SUPPORT POLICY**

FAIRCHILD'S PRODUCTS ARE NOT AUTHORIZED FOR USE AS CRITICAL COMPONENTS IN LIFE SUPPORT DEVICES OR SYSTEMS WITHOUT THE EXPRESS WRITTEN APPROVAL OF FAIRCHILD SEMICONDUCTOR CORPORATION.

As used here in:

1. Life support devices or systems are devices or systems which, (a) are intended for surgical implant into the body or (b) support or sustain life, and (c) whose failure to perform when properly used in accordance with instructions for use provided in the labeling, can be reasonably expected to result in a significant injury of the user.
2. A critical component in any component of a life support, device, or system whose failure to perform can be reasonably expected to cause the failure of the life support device or system, or to affect its safety or effectiveness.

**ANTI-COUNTERFEITING POLICY**

Fairchild Semiconductor Corporation's Anti-Counterfeiting Policy. Fairchild's Anti-Counterfeiting Policy is also stated on our external website, [www.fairchildsemi.com](http://www.fairchildsemi.com), under Sales Support.

Counterfeiting of semiconductor parts is a growing problem in the industry. All manufactures of semiconductor products are experiencing counterfeiting of their parts. Customers who inadvertently purchase counterfeit parts experience many problems such as loss of brand reputation, substandard performance, failed application, and increased cost of production and manufacturing delays. Fairchild is taking strong measures to protect ourselves and our customers from the proliferation of counterfeit parts. Fairchild strongly encourages customers to purchase Fairchild parts either directly from Fairchild or from Authorized Fairchild Distributors who are listed by country on our web page cited above. Products customers buy either from Fairchild directly or from Authorized Fairchild Distributors are genuine parts, have full traceability, meet Fairchild's quality standards for handling and storage and provide access to Fairchild's full range of up-to-date technical and product information. Fairchild and our Authorized Distributors will stand behind all warranties and will appropriately address and warranty issues that may arise. Fairchild will not provide any warranty coverage or other assistance for parts bought from Unauthorized Sources. Fairchild is committed to combat this global problem and encourage our customers to do their part in stopping this practice by buying direct or from authorized distributors.

**PRODUCT STATUS DEFINITIONS**

**Definition of Terms**

| Datasheet Identification | Product Status        | Definition  |
|--------------------------|-----------------------|---|
| Advance Information      | Formative / In Design | Datasheet contains the design specifications for product development. Specifications may change in any manner without notice.   |
| Preliminary              | First Production      | Datasheet contains preliminary data; supplementary data will be published at a later date. Fairchild Semiconductor reserves the right to make changes at any time without notice to improve design. |
| No Identification Needed | Full Production       | Datasheet contains final specifications. Fairchild Semiconductor reserves the right to make changes at any time without notice to improve the design.   |
| Obsolete                 | Not In Production     | Datasheet contains specifications on a product that is discontinued by Fairchild Semiconductor. The datasheet is for reference information only.  |

Rev. I71

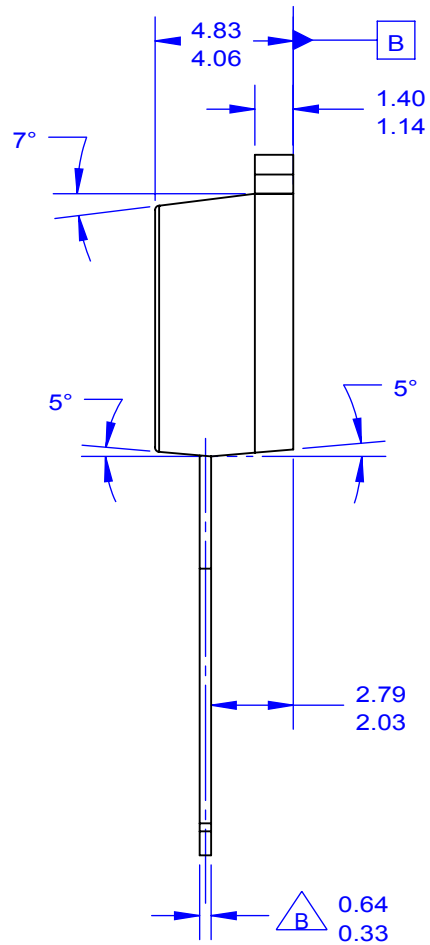
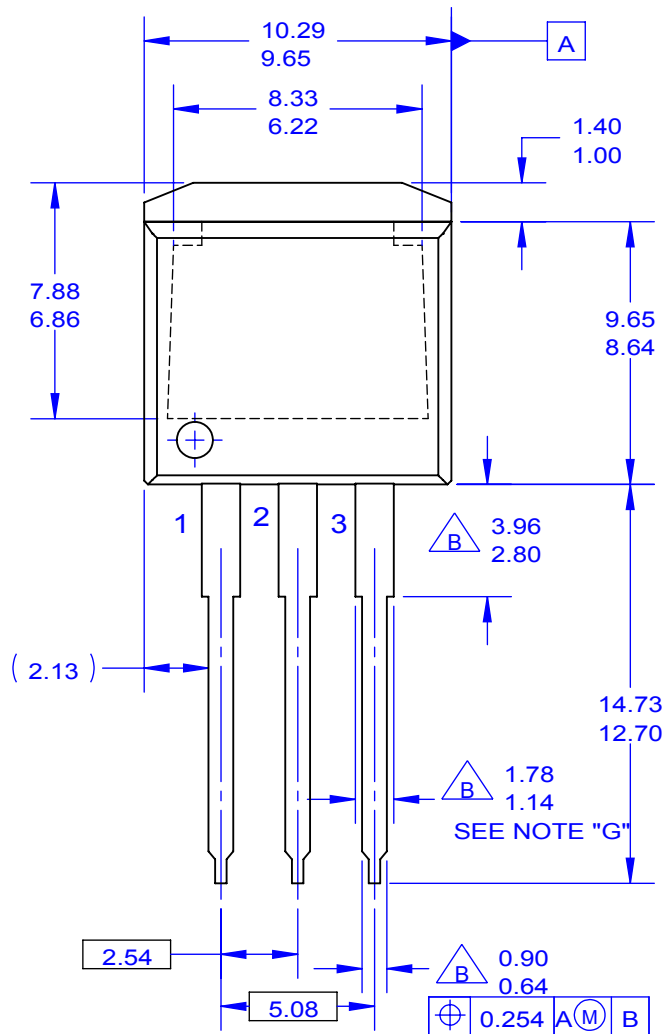

NOTES:

- A. EXCEPT WHERE NOTED CONFORMS TO TO262 JEDEC VARIATION AA.
- B. DOES NOT COMPLY JEDEC STD. VALUE.
- C. ALL DIMENSIONS ARE IN MILLIMETERS.
- D. DIMENSIONS ARE EXCLUSIVE OF BURRS, MOLD FLASH AND TIE BAR PROTRUSIONS.
- E. DIMENSION AND TOLERANCE AS PER ANSI Y14.5-1994.
- F. LOCATION OF PIN HOLE MAY VARY (LOWER LEFT CORNER, LOWER CENTER AND CENTER OF PACKAGE)
- G. MAXIMUM WIDTH FOR F102 DEVICE = 1.35 MAX.
- H. DRAWING FILE NAME: TO262A03REV6





ON Semiconductor and  are trademarks of Semiconductor Components Industries, LLC dba ON Semiconductor or its subsidiaries in the United States and/or other countries. ON Semiconductor owns the rights to a number of patents, trademarks, copyrights, trade secrets, and other intellectual property. A listing of ON Semiconductor's product/patent coverage may be accessed at [www.onsemi.com/site/pdf/Patent-Marking.pdf](http://www.onsemi.com/site/pdf/Patent-Marking.pdf). ON Semiconductor reserves the right to make changes without further notice to any products herein. ON Semiconductor makes no warranty, representation or guarantee regarding the suitability of its products for any particular purpose, nor does ON Semiconductor assume any liability arising out of the application or use of any product or circuit, and specifically disclaims any and all liability, including without limitation special, consequential or incidental damages. Buyer is responsible for its products and applications using ON Semiconductor products, including compliance with all laws, regulations and safety requirements or standards, regardless of any support or applications information provided by ON Semiconductor. "Typical" parameters which may be provided in ON Semiconductor data sheets and/or specifications can and do vary in different applications and actual performance may vary over time. All operating parameters, including "Typicals" must be validated for each customer application by customer's technical experts. ON Semiconductor does not convey any license under its patent rights nor the rights of others. ON Semiconductor products are not designed, intended, or authorized for use as a critical component in life support systems or any FDA Class 3 medical devices or medical devices with a same or similar classification in a foreign jurisdiction or any devices intended for implantation in the human body. Should Buyer purchase or use ON Semiconductor products for any such unintended or unauthorized application, Buyer shall indemnify and hold ON Semiconductor and its officers, employees, subsidiaries, affiliates, and distributors harmless against all claims, costs, damages, and expenses, and reasonable attorney fees arising out of, directly or indirectly, any claim of personal injury or death associated with such unintended or unauthorized use, even if such claim alleges that ON Semiconductor was negligent regarding the design or manufacture of the part. ON Semiconductor is an Equal Opportunity/Affirmative Action Employer. This literature is subject to all applicable copyright laws and is not for resale in any manner.

## PUBLICATION ORDERING INFORMATION

### LITERATURE FULFILLMENT:

Literature Distribution Center for ON Semiconductor  
19521 E. 32nd Pkwy, Aurora, Colorado 80011 USA  
**Phone:** 303-675-2175 or 800-344-3860 Toll Free USA/Canada  
**Fax:** 303-675-2176 or 800-344-3867 Toll Free USA/Canada  
**Email:** [orderlit@onsemi.com](mailto:orderlit@onsemi.com)

**N. American Technical Support:** 800-282-9855 Toll Free  
USA/Canada  
**Europe, Middle East and Africa Technical Support:**  
Phone: 421 33 790 2910  
**Japan Customer Focus Center**  
Phone: 81-3-5817-1050

**ON Semiconductor Website:** [www.onsemi.com](http://www.onsemi.com)  
**Order Literature:** <http://www.onsemi.com/orderlit>  
For additional information, please contact your local  
Sales Representative