

TQFP-144 to PGA-144 SMT Adapter (0.4 mm pitch, 16 x 16 mm body)

REF.	DIMENSIONS					
	mm			inches		
	MIN.	TYP.	MAX.	MIN.	TYP.	MAX.
A		15.60				
A2		15.60				
B		2.00				
C		0.20				
D		0.20				
E		0.40				

Top View (SMT Footprint)

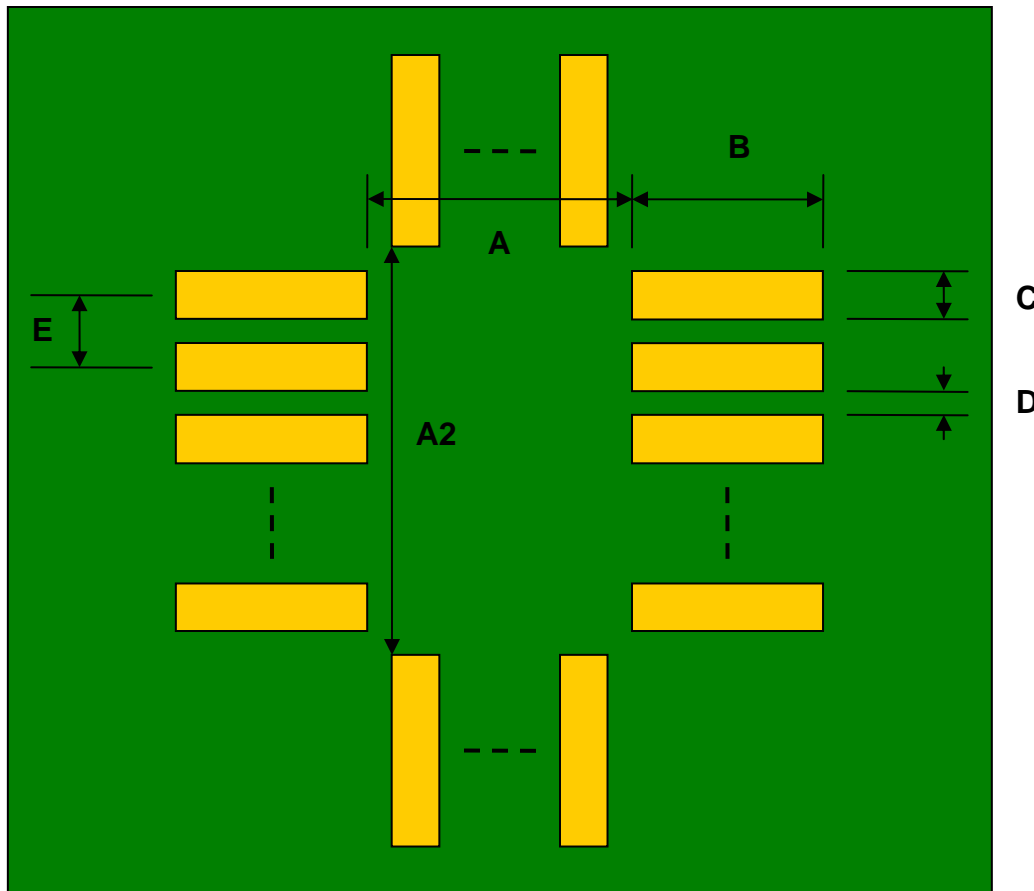

(Representative drawing only - not to scale)