

REVISIONS

P	LTR	DESCRIPTION	DATE	DWN	APVD
	A	INITIAL RELEASE	19MAR2015	DL	CW
	A1	ECR-15-009224	23JUN2015	DL	CW
	B	ECR-15-013292	24SEP2015	DL	CW

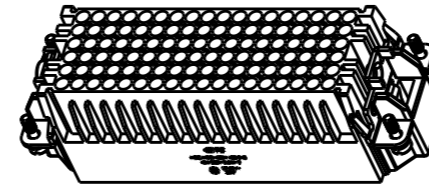
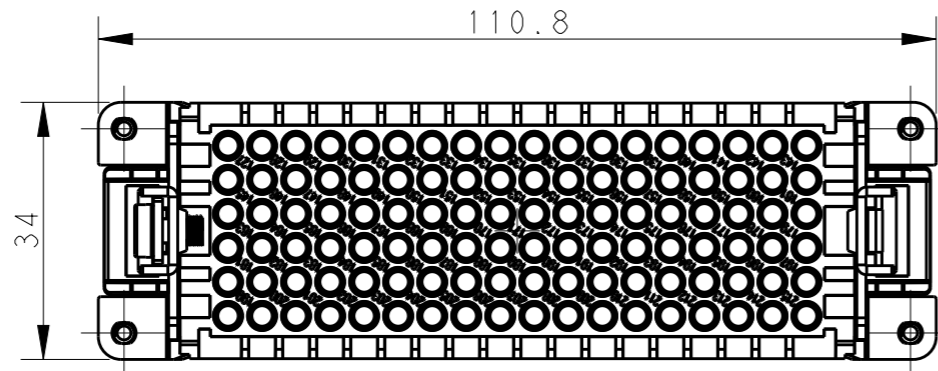

SCALE 1:2

NOTES:

- TECHNICAL CHARACTERISTICS:
 INSULATION MATERIAL: PC
 RATED VOLTAGE: 250 V
 RATED CURRENT: 10 A
 INSULATION RESISTANCE: $\geq 400M\Omega$
 RATED IMPULSE VOLTAGE: 2.5 KV
 POLLUTION DEGREE: 2
 FLAMMABILITY: UL94V-0
 MATING CYCLES: 500 CYCLES
 OPERATION TEMPERATURE: $-40-+125^{\circ}C$
 WIRE RANGE: 0.14-2.5 mm² (26-14 AWG)
 CONTACT TYPE: CRIMP CONTACT
- CONTACT NEED TO BE ORDERED SEPARATELY.
 (ORDER No. REFER TO DRAWING: T20200X10XX000)

M4 SCREW
RECOMMENDED TIGHTENING TORQUE 1.2Nm

4 X M3 SCREW
RECOMMENDED TIGHTENING TORQUE 0.5Nm

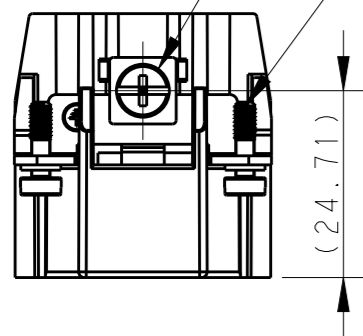

(24.71)

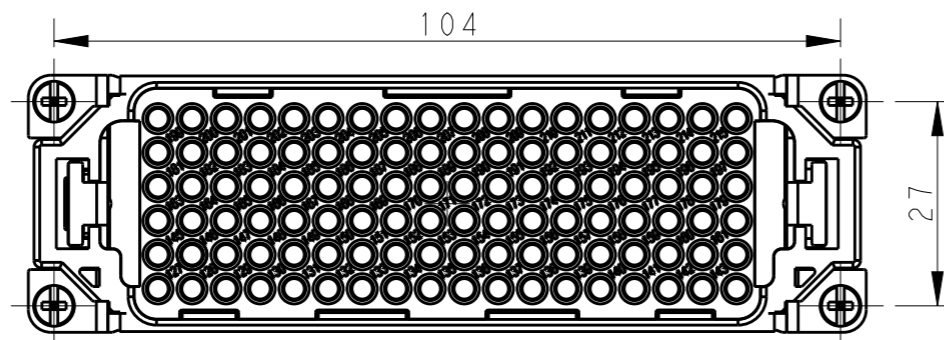
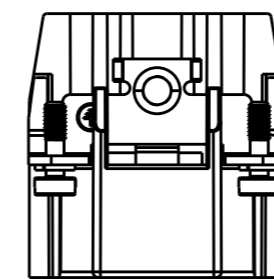
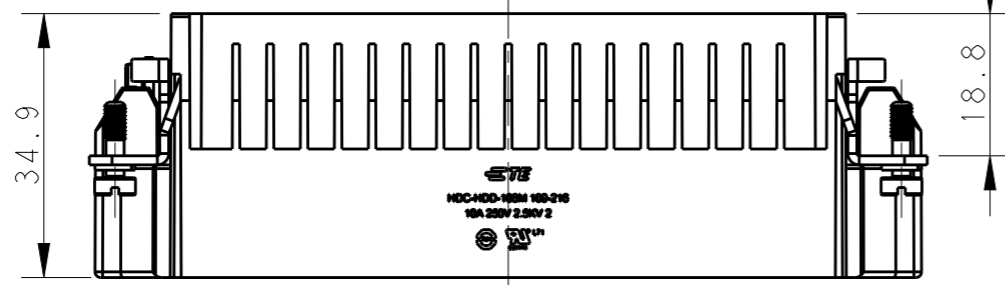

注释:

- 技术参数:
 绝缘材料: PC
 额定电压: 250V
 额定电流: 10A
 绝缘电阻: $\geq 400M\Omega$
 额定脉冲电压: 2.5 KV
 污染等级: 2
 阻燃等级: UL94V-0
 插拔次数: 500次
 工作温度: $-40-+125^{\circ}C$
 接线范围: 0.14-2.5 mm² (26-14 AWG)
 接线类型: 冷压接
- 端子需要单独订购。
 (订货号参考图面: T20200X10XX000)

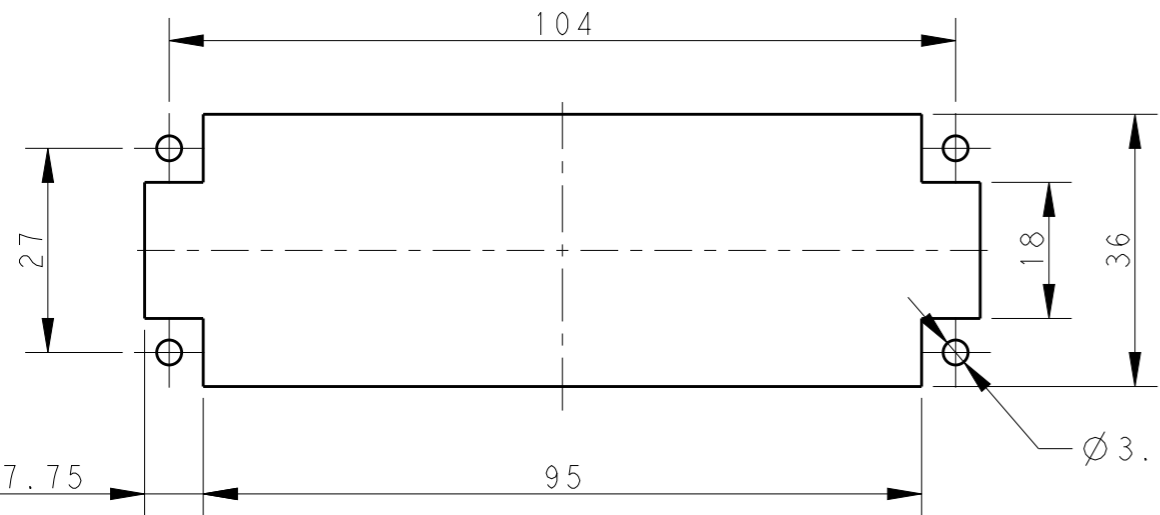

PANEL CUT OUT FOR INSERTS FOR USING WITHOUT HOODS/HOUSINGS

THIS DRAWING IS A CONTROLLED DOCUMENT.

DIMENSIONS:	TOLERANCES UNLESS OTHERWISE SPECIFIED:
mm	
	0 PLC ±-
	1 PLC ±-
	2 PLC ±-
	3 PLC ±-
	4 PLC ±-
	ANGLES ±-
MATERIAL	FINISH
-	-
-	-

DWN	DAVID LI	18MAR2015
CHK	CHRIS WANG	18MAR2015
APVD	XU XIANG	18MAR2015
PRODUCT SPEC	108-137043	
APPLICATION SPEC	114-137043	
WEIGHT	-	
CUSTOMER DRAWING		

HDC-HDD-108M 109-216		T2032162101-000	
DESCRIPTION		PART NUMBER	
TE Connectivity			
NAME HDC-HDD-108M 109-216			
SIZE	CAGE CODE	DRAWING NO	RESTRICTED TO
A3	-	©-T2032162101000	-
SCALE 1:1		SHEET 1 OF 1	REV B