

SPECIFICATIONS

RoHS Compliant



Model Number: JQD48B3E2X-E3
Part Number: 17001183A

Rev:00
Jun 12, 2018

Mechanical Drawing:

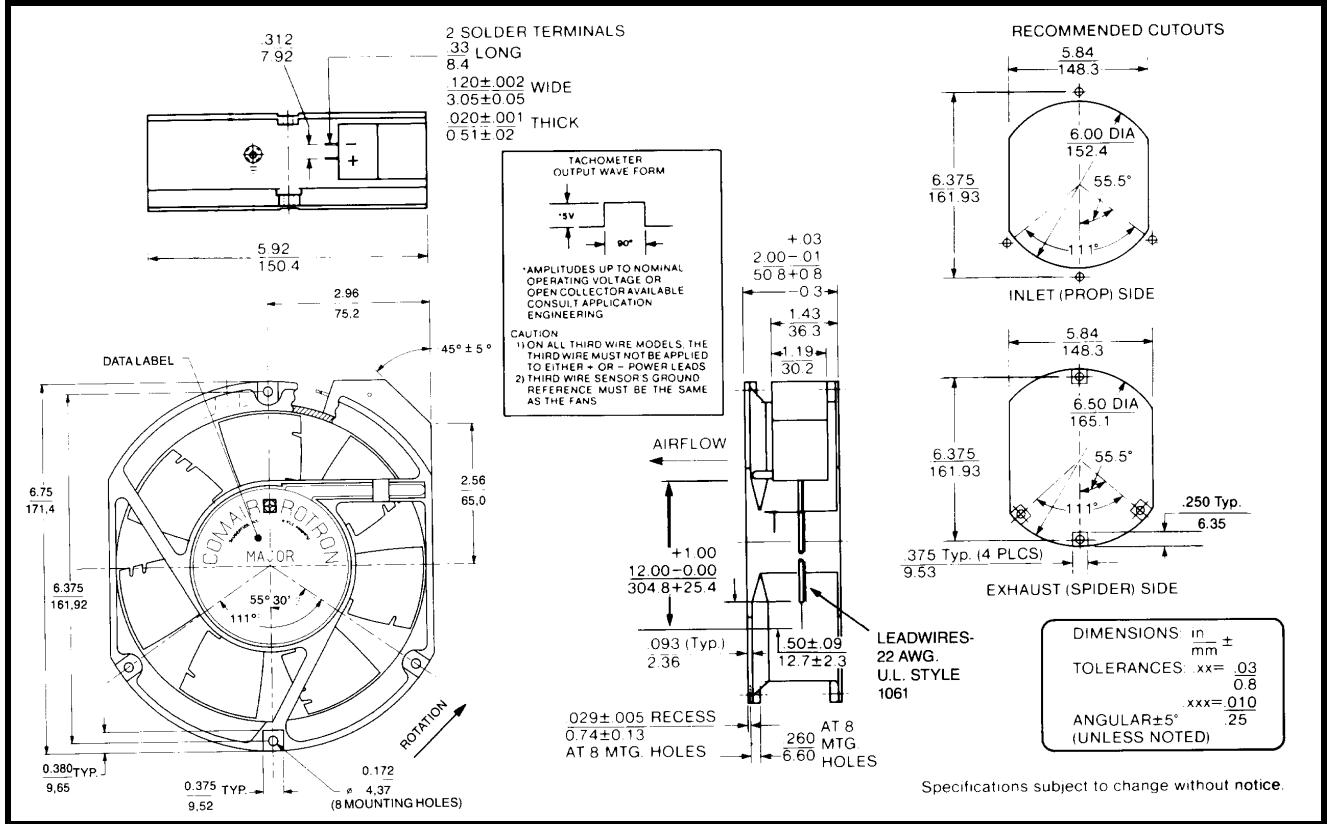

Motor:

Nominal Voltage	= 48 vdc
Operating Voltage Range	= 36 - 60 vdc
Nominal Running Current	= 0.46mps
Locked Rotor Current	= 1.0 amps
Running Power	= 22.1 watts
Average Speed	= 3400 RPM
Bearings	= Ball
Air Flow	= 235 CFM
Acoustic	= 54.3 dBA

Construction:

Venturi: Die-cast aluminum, painted black
 Propeller: Plastic, painted black

Life Expectancy:

This fan is designed for continuous duty life of 58,000 hours at 70°C.

Termination:

12"±1"(304.8±25.4mm) 22AWG UL1061 Leadwires

Red	= Power(+)
Black	= Return(-)
Blue/White	= Tach output
Yellow	= PWM control

Additional Features:

Brushless DC Motor	
Soft Start Inrush Current	
Electronic Locked Rotor Protection	
Polarity Protected	
Automatic Restart Capability	
Operating Temperature:	-10°C to 70°C
Storage Temperature:	-40°C to 85°C
Environmental Protection:	Type 3(IP68)

TACHOMETER:

Output:	Open Collector
Ic:	20 mA max.
Vcc:	60 Vdc max.
Pulses per Revolution:	2
Isolated:	No

Speed Control:

PWM:	200 ~ 2 KHz, Open Collector
<10% Duty:	Off
10%~95% Duty:	Linear Ramp
>95% Duty or Open Lead Wire:	Full Speed

Agency Approvals:

UL, CUL, CE

PQ Curve:

