

NTC Accurate Thermistors

NP30 - NJ 28 – NI 24 – NK 20

High precision resistance and an outstanding ability to reproduce the sensibility index B, make these ranges of products the types of thermistors ideal for temperature measurement applications.

Leaded or unled, these small size and rapid response time thermistors are able to meet the most accurate requirements.

FEATURES

- High Accuracy
- Fast thermal response
- Commercial, Industrial and Automotive Applications
- AEC-Q200 qualified

OPTIONS

Consult factory for availability of options

- other nominal resistance values
- other tolerances
- controlled dimensions (e.g. reduced head size for NP30)
- alternative lead materials (e.g. steel, nickel)
- customized lead lengths, spacing, forming (kink) etc.
- epoxy coating on leads (NP30)

APPLICATIONS

- Temperature measurement
- Liquid level or flow detection
- Alarms and fire detectors
- HVAC and Refrigeration
- Fans
- Air intake temperature
- Electric pup module
- Water Temperature
- Evaporator probe
- and more

Types	NJ 28	NP 30	NI 24	NK 20
Finish	Coated chip with phenolic resin + varnish + tinned copper wires	Coated chip with epoxy	Coated chip with epoxy AWG30 insulated leads + Silver plated nickel wires	Chip
DIMENSIONS: millimeters (inches)				
Marking	On packaging only			
Operating temperature	-55°C to +150°C			
Tolerance on Rn (25°C)	±1%, ±2%, ±3%			
Maximum dissipation at 25°C	0.16 W			
Thermal dissipation factor*	3 mW/°C		3 mW/°C	2 mW/°C
Thermal time constant	8 s		8 s	6 s
Response time	< 2 s			

NTC Accurate Thermistors

NP30 - NJ 28 – NI 24 – NK 20



TABLE OF VALUES

Types	Rn at 25°C (Ω)	Material Code	B (K)	α at 25°C (%/°C)
N_ _ _ KA 0202	2,000	KA	3625 ± 1%	- 4.1
N_ _ _ MA 0302	3,000	MA	3965 ± 0.5%	- 4.5
N_ _ _ MA 0502	5,000	MA	3965 ± 0.5%	- 4.5
N_ _ _ MA 0103	10,000	MA	3965 ± 0.5%	- 4.5
N_ _ _ NA 0103	10,000	NA	4100 ± 1%	- 4.6
N_ _ _ PA 0203	20,000	PA	4235 ± 1%	- 4.8
N_ _ _ QA 0503	50,000	QA	4250 ± 1%	- 4.8
N_ _ _ RA 0104	100,000	RA	4380 ± 1%	- 4.9

* -- = Add type as outlined above (Example NJ 2 8).

Resistance - Temperature characteristics: pages 30 to 34.

HOW TO ORDER

NJ28



Type
NP30
NJ28
NI24

MA



Material Code
MA
(See table above)

0502



Resistance
5 kΩ
(See table above)

M



Tolerance
F (±1%)
G (±2%)
H (±3%)

--



Packaging
--: Bulk
Ammopack (for NP30 and NJ28)
(See table page 25)
Tape and reel (for NP30 and NJ28)
(See table page 25)

NTC Thermistors Manufacturing Process



NP30 - NJ 28 - NI 24 - NK 20

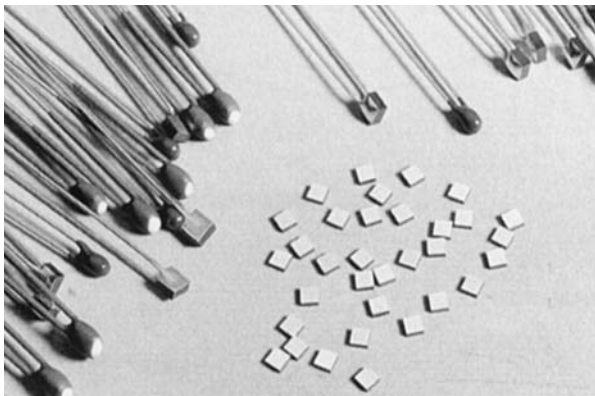
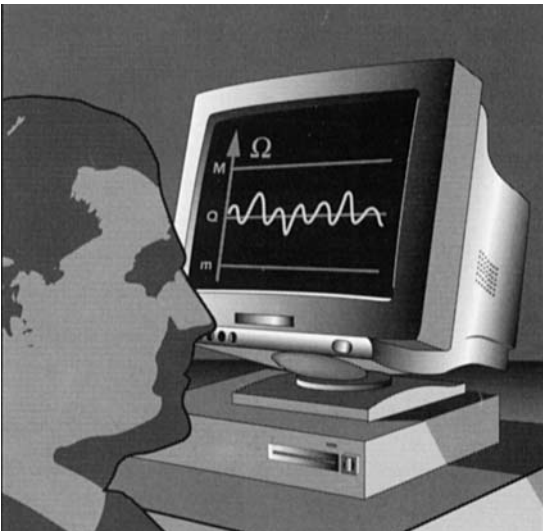
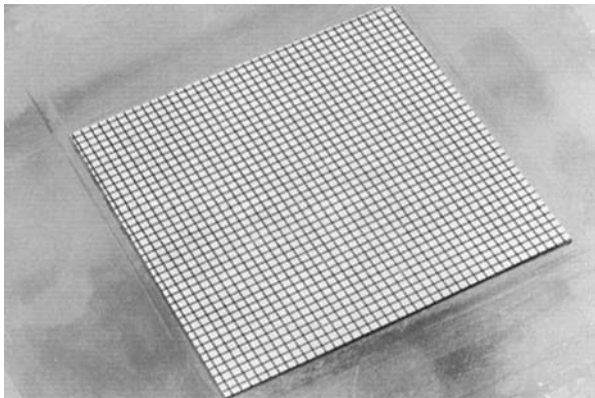
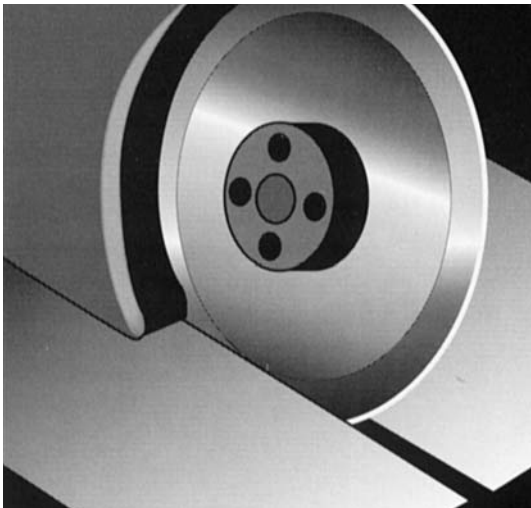
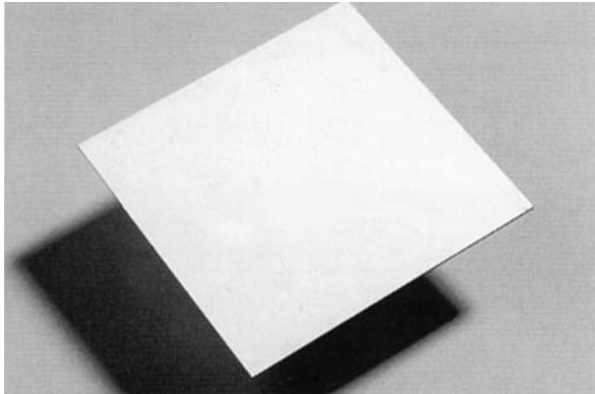
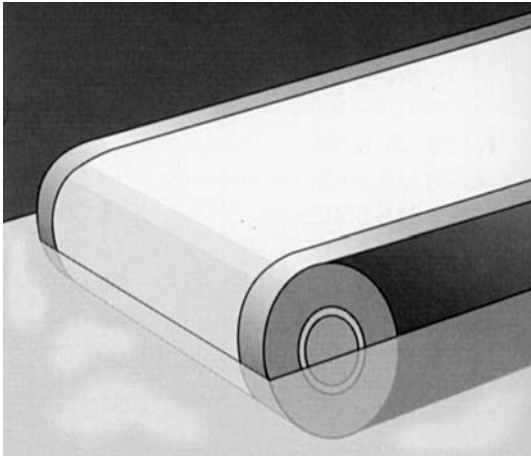

NTC Disc Thermistors

Packaging for Automatic Insertion



PACKAGING AND KINK SUFFIXES

Tables below indicate the suffixes to specify when ordering to get the required kink and packaging. For devices on tape, it is necessary to specify the height (H or Ho) which is the distance between the tape axis (sprocket holes axis) and the seating plane on the printed circuit board. The following types can be ordered on tape either in AMMOPACK (fan folder) or on REEL in accordance with IEC 286-2.

– Straight leads:

H represents the distance between the sprocket holes axis and the bottom plane of component body (base of resin or base of stand off).

– Kinked leads and flat leads:

Ho represents the distance between the sprocket holes axis and the base on the knee (kinked leads) or the bottom of the flat part (flat leads).

• Reel & Ammopack

millimeters (inches)

Types	Suffix	H or Ho	Leads	Quantity/Size	Packaging
ND/NE 03 & NJ28	CA	16 ± 0.5 (0.630 ± 0.020)	Straight	3000	AMMOPACK
	CB	16 ± 0.5 (0.630 ± 0.020)	Straight	3000	REEL
	CC	19.5 ± 0.5 (0.768 ± 0.020)	Straight	3000	AMMOPACK
	CD	19.5 ± 0.5 (0.768 ± 0.020)	Straight	3000	REEL
NP30	CA	16 ± 0.5 (0.630 ± 0.020)	Straight	1500	AMMOPACK
	CB	16 ± 0.5 (0.630 ± 0.020)	Straight	1500	REEL
	CC	19.5 ± 0.5 (0.768 ± 0.020)	Straight	3000	AMMOPACK
	CD	19.5 ± 0.5 (0.768 ± 0.020)	Straight	3000	REEL
ND/NE/NV 06/09	DA	16 ± 0.5 (0.630 ± 0.020)	Straight	1500	AMMOPACK
	DB	16 ± 0.5 (0.630 ± 0.020)	Straight	1500	REEL
	DC	19.5 ± 0.5 (0.768 ± 0.020)	Straight	1500	AMMOPACK
	DD	19.5 ± 0.5 (0.768 ± 0.020)	Straight	1500	REEL
	DL	16 ± 0.5 (0.630 ± 0.020)	Kinked	1500	AMMOPACK
	DM	16 ± 0.5 (0.630 ± 0.020)	Kinked	1500	REEL
	DN	19.5 ± 0.5 (0.768 ± 0.020)	Kinked	1500	AMMOPACK
	DP	19.5 ± 0.5 (0.768 ± 0.020)	Kinked	1500	REEL

NTC

Type
ND03
NE03
NJ28
NP30

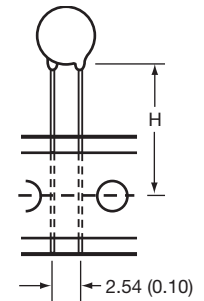

NTC

Types
ND/NE/NV
06/09

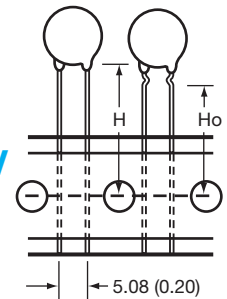

• Bulk

Type	Quantity/box
ND/NE03	3000
ND/NE06	1500
ND/NE09	1500
NV06	100
NV09	100
NI24 NJ28 NK20 NP30	1000



Automatic Insertion

NTC Disc Thermistors



TAPING CHARACTERISTICS

Missing components

A maximum of 3 consecutive components may be missing from the bandolier, surrounded by at least 6 filled positions. The number of missing components may not exceed 0.5% of the total per packing module.

The beginning and the end of tape exhibit 8 or 9 blank positions.

DIMENSIONS: millimeters (inches)

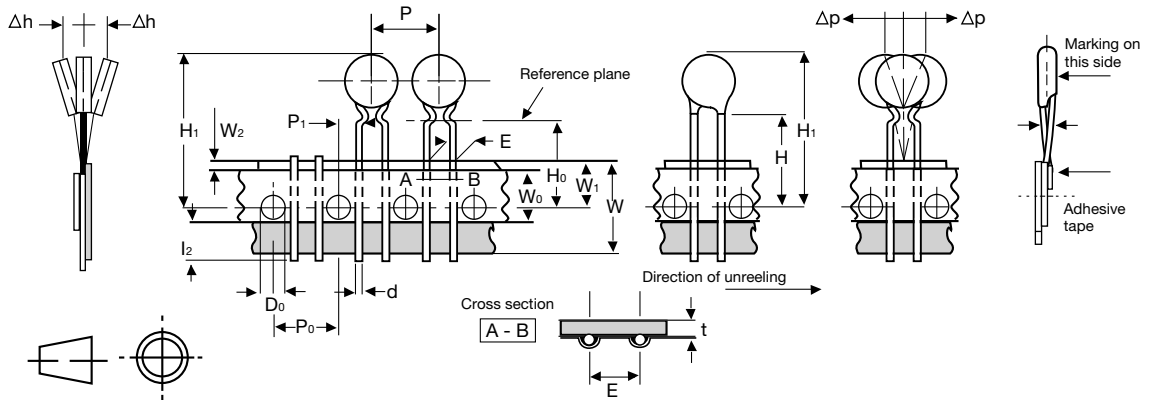
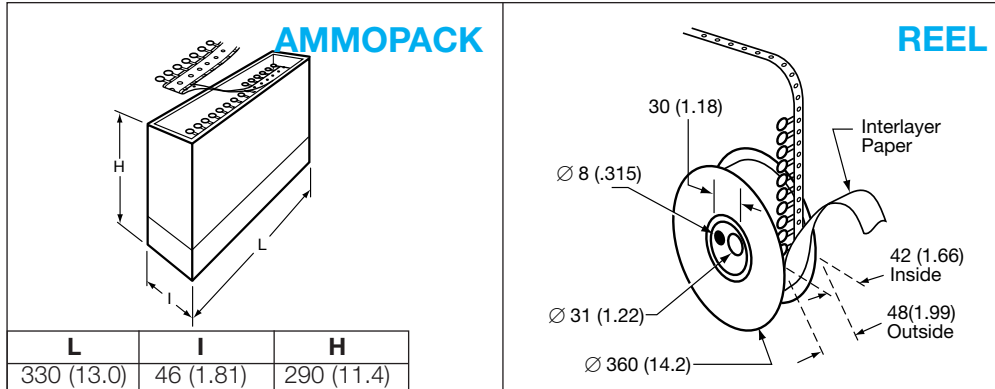

Value	Tolerance	Dimensions Characteristics
18	+1 / -0.5	W Leading tape width
6	±0.3	W ₀ Adhesive tape width
9	+0.75 / -0.5	W ₁ Sprocket hole position
3 max.		W ₂ Distance between the top of the tape and the adhesive
4	±0.2	D ₀ Diameter of sprocket hole
16/19.5	±0.5	H ₀ Distance between the tape axis and the seating plane of the component
		H ₁ Distance between the tape axis and the top of component body

Value	Tolerance	Dimensions Characteristics
12.7	±0.2	P ₀ Sprocket holes pitch
254	±1	- Distance between 21 consecutive holes 20 pitches
0.7	±0.2	t Total thickness of tape
2.54 5.08	+0.6 -0.1	E Lead spacing
5.08 3.85	± 0.7	P ₁ Distance between the sprocket hole axis and the lead axis
12.7	±1.0	P Spacing of components
0.5 0.6	±5%	d Lead diameter
0	±1.3	°P Verticality of components
0	±2	°h Alignment of components



Tables of Resistance vs Temperature

T (°C)	Material B(K)		
	I 3250		
	R(T) / R25	TF (%)	α (%/°C)
-55	42.35	21.9	-5.98
-50	31.48	20.0	-5.78
-45	23.63	18.1	-5.59
-40	17.91	16.3	-5.41
-35	13.70	14.6	-5.23
-30	10.58	13.1	-5.06
-25	8.232	11.6	-4.90
-20	6.460	10.1	-4.74
-15	5.110	8.8	-4.59
-10	4.072	7.5	-4.45
-5	3.268	6.3	-4.31
0	2.641	5.1	-4.18
5	2.148	4.0	-4.05
10	1.759	2.9	-3.92
15	1.449	1.9	-3.81
20	1.200	0.9	-3.69
25	1.000	0.0	-3.58
30	0.8377	0.9	-3.48
35	0.7054	1.8	-3.38
40	0.5969	2.6	-3.28
45	0.5076	3.5	-3.19
50	0.4336	4.3	-3.10
55	0.3720	5.1	-3.01
60	0.3206	5.9	-2.93
65	0.2774	6.6	-2.85
70	0.2410	7.4	-2.77
75	0.2102	8.1	-2.70
80	0.1839	8.8	-2.63
85	0.1616	9.5	-2.56
90	0.1424	10.2	-2.49
95	0.1259	10.9	-2.43
100	0.1117	11.5	-2.36
105	0.09938	12.2	-2.30
110	0.08869	12.8	-2.25
115	0.07938	13.4	-2.19
120	0.07124	14.0	-2.14
125	0.06410	14.6	-2.08
130	0.05783	15.2	-2.03
135	0.05230	15.7	-1.98
140	0.04741	16.3	-1.94
145	0.04308	16.8	-1.89
150	0.03924	17.4	-1.85

T (°C)	Material B(K)		
	J-15 3480		
	R(T) / R25	TF (%)	α (%/°C)
-55	51.75	20.5	-6.23
-50	37.98	17.7	-6.03
-45	28.15	15.2	-5.84
-40	21.07	13.0	-5.65
-35	15.91	11.0	-5.48
-30	12.13	9.3	-5.31
-25	9.321	7.8	-5.15
-20	7.222	6.4	-4.99
-15	5.640	5.2	-4.84
-10	4.438	4.2	-4.69
-5	3.517	3.3	-4.55
0	2.807	2.5	-4.42
5	2.255	1.8	-4.29
10	1.824	1.2	-4.17
15	1.484	0.7	-4.05
20	1.215	0.3	-3.93
25	1.0000	0.0	-3.82
30	0.8278	0.3	-3.71
35	0.6889	0.7	-3.61
40	0.5763	1.1	-3.51
45	0.4845	1.5	-3.41
50	0.4092	2.0	-3.32
55	0.3472	2.5	-3.23
60	0.2960	3.0	-3.15
65	0.2533	3.5	-3.06
70	0.2177	4.1	-2.98
75	0.1879	4.7	-2.90
80	0.1628	5.3	-2.83
85	0.1415	5.9	-2.76
90	0.12349	6.5	-2.69
95	0.10813	7.1	-2.62
100	0.09499	7.7	-2.55
105	0.08372	8.4	-2.49
110	0.07402	9.0	-2.43
115	0.06564	9.7	-2.37
120	0.05837	10.3	-2.31
125	0.05206	11.0	-2.26
130	0.04656	11.6	-2.21
135	0.04175	12.3	-2.15
140	0.03753	13.0	-2.10
145	0.03382	13.6	-2.06
150	0.03055	14.3	-2.01

T (°C)	Material B(K)		
	K 3630		
	R(T) / R25	TF (%)	α (%/°C)
-55	56.27	21.4	-6.25
-50	41.22	18.5	-6.06
-45	30.48	15.9	-5.89
-40	22.74	13.6	-5.71
-35	17.11	11.5	-5.55
-30	12.98	9.7	-5.39
-25	9.931	8.1	-5.24
-20	7.655	6.7	-5.09
-15	5.945	5.4	-4.95
-10	4.651	4.4	-4.81
-5	3.663	3.4	-4.67
0	2.905	2.6	-4.54
5	2.319	1.9	-4.42
10	1.862	1.3	-4.30
15	1.505	0.8	-4.18
20	1.223	0.3	-4.07
25	1.0000	0.0	-3.96
30	0.8219	0.3	-3.85
35	0.6792	0.7	-3.75
40	0.5641	1.1	-3.65
45	0.4708	1.6	-3.55
50	0.3949	2.1	-3.46
55	0.3327	2.6	-3.37
60	0.2816	3.1	-3.28
65	0.2393	3.7	-3.20
70	0.2043	4.3	-3.12
75	0.1751	4.9	-3.04
80	0.1506	5.5	-2.96
85	0.1301	6.1	-2.89
90	0.1128	6.8	-2.82
95	0.09811	7.4	-2.75
100	0.08564	8.1	-2.68
105	0.07501	8.7	-2.61
110	0.06591	9.4	-2.55
115	0.05809	10.1	-2.49
120	0.05136	10.8	-2.43
125	0.04554	11.5	-2.37
130	0.04049	12.2	-2.32
135	0.03611	12.8	-2.26
140	0.03228	13.5	-2.21
145	0.02893	14.2	-2.16
150	0.02600	14.9	-2.11

T (°C)	Material B(K)		
	KA 3625		
	R(T) / R25	TF (%)	α (%/°C)
-55	61.22	7.1	-6.55
-50	44.25	6.1	-6.33
-45	32.34	5.3	-6.12
-40	23.88	4.5	-5.92
-35	17.81	3.8	-5.73
-30	13.41	3.2	-5.54
-25	10.19	2.7	-5.37
-20	7.815	2.2	-5.20
-15	6.041	1.8	-5.04
-10	4.707	1.5	-4.89
-5	3.696	1.1	-4.74
0	2.923	0.9	-4.60
5	2.329	0.6	-4.46
10	1.867	0.4	-4.33
15	1.507	0.3	-4.21
20	1.224	0.1	-4.09
25	1.0000	0.0	-3.97
30	0.8217	0.1	-3.86
35	0.6788	0.2	-3.75
40	0.5638	0.4	-3.65
45	0.4707	0.5	-3.55
50	0.3948	0.7	-3.46
55	0.3328	0.9	-3.37
60	0.2817	1.0	-3.28
65	0.2396	1.2	-3.19
70	0.2046	1.4	-3.11
75	0.1754	1.6	-3.03
80	0.1510	1.8	-2.96
85	0.1305	2.0	-2.88
90	0.1131	2.3	-2.81
95	0.09844	2.5	-2.74
100	0.08596	2.7	-2.68
105	0.07530	2.9	-2.61
110	0.06618	3.1	-2.55
115	0.05833	3.4	-2.49
120	0.05157	3.6	-2.43
125	0.04573	3.8	-2.38
130	0.04065	4.0	-2.32
135	0.03624	4.3	-2.27
140	0.03239	4.5	-2.22
145	0.02902	4.7	-2.17
150	0.02607	5.0	-2.12

T (°C)	Material B(K)		
	KC 3470		
	R(T) / R25	TF (%)	α (%/°C)
-55	60.08	34.0	-7.00
-50	43.19	29.4	-6.71
-45	31.42	25.3	-6.44
-40	23.13	21.6	-6.18
-35	17.22	18.4	-5.94
-30	12.95	15.5	-5.71
-25	9.842	12.9	-5.49
-20	7.550	10.7	-5.29
-15	5.845	8.7	-5.10
-10	4.564	6.9	-4.91
-5	3.594	5.4	-4.74
0	2.853	4.1	-4.58
5	2.281	3.0	-4.42
10	1.838	2.0	-4.27
15	1.491	1.2	-4.13
20	1.217	0.5	-4.00
25	1.0000	0.0	-3.90
30	0.8267	0.5	-3.74
35	0.6873	1.1	-3.63
40	0.5747	1.8	-3.52
45	0.4830	2.5	-3.41
50	0.4081	3.3	-3.31
55	0.3465	4.1	-3.21
60	0.2955	5.0	-3.12
65	0.2532	5.9	-3.03
70	0.2179	6.8	-2.94
75	0.1883	7.8	-2.86
80	0.1634	8.7	-2.78
85	0.1423	9.7	-2.71
90	0.1244	10.8	-2.63
95	0.10915	11.8	-2.56
100	0.09608	12.9	-2.50
105	0.08486	13.9	-2.43
110	0.07519	15.0	-2.37
115	0.06683	16.1	-2.31
120	0.05957	17.2	-2.25
125	0.05325	18.3	-2.20
130	0.04774	19.4	-2.14
135	0.04290	20.5	-2.09
140	0.03866	21.6	-2.04
145	0.03492	22.7	-1.99
150	0.03162	23.8	-1.95

T (°C)	Material B(K)		
	L 3790		
	R(T) / R25	TF (%)	α (%/°C)
-55	82.54	22.3	-7.12
-50	58.03	19.3	-6.87
-45	41.31	16.6	-6.63
-40	29.75	14.2	-6.40
-35	21.68	12.0	-6.18
-30	15.97	10.1	-5.98
-25	11.88	8.5	-5.78
-20	8.931	7.0	-5.59
-15	6.777	5.7	-5.40
-10	5.188	4.5	-5.23
-5	4.007	3.6	-5.06
0	3.120	2.7	-4.90
5	2.449	2.0	-4.75
10	1.937	1.3	-4.60
15	1.543	0.8	-4.46
20	1.238	0.4	-4.33
25	1.0000	0.0	-4.20
30	0.8128	0.3	-4.07
35	0.6648	0.7	-3.95
40	0.5469	1.2	-3.84
45	0.4525	1.6	-3.73
50	0.3764	2.2	-3.62
55	0.3148	2.7	-3.52
60	0.2646	3.3	-3.42
65	0.2235	3.8	-3.33
70	0.1896	4.5	-3.24
75	0.1616	5.1	-3.15
80	0.1383	5.7	-3.07
85	0.1189	6.4	-2.98
90	0.1026	7.1	-2.91
95	0.08888	7.7	-2.83
100	0.07728	8.4	-2.76
105	0.06744	9.1	-2.69
110	0.05905	9.8	-2.62
115	0.05188	10.5	-2.56
120	0.04572	11.3	-2.49
125	0.04042	12.0	-2.43
130	0.03585	12.7	-2.37
135	0.03188	13.4	-2.32
140	0.02843	14.1	-2.26
145	0.02542	14.8	-2.21
150	0.02279	15.6	-2.16

Tables of Resistance vs Temperature



T (°C)	Material B(K)		
	L2 3805		
	R(T) / R25	TF (%)	α (%/°C)
-55	62.45	22.4	-6.41
-50	45.40	19.3	-6.22
-45	33.33	16.6	-6.03
-40	24.70	14.2	-5.85
-35	18.47	12.1	-5.68
-30	13.92	10.2	-5.52
-25	10.58	8.5	-5.36
-20	8.110	7.0	-5.21
-15	6.260	5.7	-5.07
-10	4.867	4.6	-4.93
-5	3.810	3.6	-4.80
0	3.003	2.7	-4.67
5	2.382	2.0	-4.55
10	1.901	1.3	-4.43
15	1.526	0.8	-4.31
20	1.232	0.4	-4.20
25	1.0000	0.0	-4.10
30	0.8161	0.3	-4.00
35	0.6694	0.7	-3.90
40	0.5518	1.2	-3.80
45	0.4570	1.7	-3.71
50	0.3802	2.2	-3.62
55	0.3178	2.7	-3.53
60	0.2667	3.3	-3.45
65	0.2248	3.9	-3.37
70	0.1902	4.5	-3.29
75	0.1615	5.1	-3.22
80	0.1377	5.8	-3.14
85	0.1179	6.4	-3.07
90	0.1012	7.1	-3.00
95	0.08721	7.8	-2.94
100	0.07539	8.5	-2.87
105	0.06538	9.2	-2.81
110	0.05688	9.9	-2.75
115	0.04963	10.6	-2.69
120	0.04343	11.3	-2.63
125	0.03812	12.0	-2.58
130	0.03354	12.7	-2.53
135	0.02960	13.5	-2.47
140	0.02618	14.2	-2.42
145	0.02322	14.9	-2.37
150	0.02064	15.6	-2.33

T (°C)	Material B(K)		
	M 3950		
	R(T) / R25	TF (%)	α (%/°C)
-55	99.59	23.2	-7.42
-50	68.97	20.1	-7.16
-45	48.40	17.3	-6.91
-40	34.38	14.8	-6.67
-35	24.71	12.5	-6.45
-30	17.97	10.6	-6.23
-25	13.20	8.8	-6.02
-20	9.804	7.3	-5.82
-15	7.352	5.9	-5.63
-10	5.565	4.7	-5.45
-5	4.251	3.7	-5.28
0	3.275	2.8	-5.11
5	2.544	2.0	-4.95
10	1.992	1.4	-4.80
15	1.572	0.8	-4.65
20	1.249	0.4	-4.51
25	1.0000	0.0	-4.38
30	0.8057	0.4	-4.25
35	0.6534	0.8	-4.12
40	0.5331	1.2	-4.00
45	0.4376	1.7	-3.89
50	0.3612	2.2	-3.77
55	0.2998	2.8	-3.67
60	0.2501	3.4	-3.57
65	0.2097	4.0	-3.47
70	0.1767	4.6	-3.37
75	0.1496	5.3	-3.28
80	0.1272	6.0	-3.19
85	0.1087	6.7	-3.11
90	0.09320	7.4	-3.03
95	0.08025	8.1	-2.95
100	0.06937	8.8	-2.87
105	0.06019	9.5	-2.80
110	0.05242	10.2	-2.73
115	0.04580	11.0	-2.66
120	0.04016	11.7	-2.60
125	0.03532	12.5	-2.53
130	0.03117	13.2	-2.47
135	0.02758	14.0	-2.41
140	0.02448	14.7	-2.36
145	0.02179	15.5	-2.30
150	0.01945	16.2	-2.25

T (°C)	Material B(K)		
	MA 3965		
	R(T) / R25	TF (%)	α (%/°C)
-55	101.1	3.9	-7.49
-50	69.81	3.4	-7.22
-45	48.87	2.9	-6.96
-40	34.65	2.5	-6.71
-35	24.87	2.1	-6.48
-30	18.06	1.8	-6.26
-25	13.26	1.5	-6.05
-20	9.837	1.2	-5.84
-15	7.372	1.0	-5.65
-10	5.578	0.8	-5.47
-5	4.259	0.6	-5.29
0	3.280	0.5	-5.12
5	2.548	0.3	-4.96
10	1.994	0.2	-4.81
15	1.573	0.1	-4.66
20	1.250	0.1	-4.52
25	1.0000	0.0	-4.38
30	0.8054	0.1	-4.25
35	0.6528	0.1	-4.13
40	0.5324	0.2	-4.01
45	0.4368	0.3	-3.90
50	0.3603	0.4	-3.79
55	0.2989	0.5	-3.68
60	0.2492	0.6	-3.58
65	0.2088	0.7	-3.48
70	0.1758	0.8	-3.39
75	0.1487	0.9	-3.30
80	0.1263	1.0	-3.21
85	0.1078	1.1	-3.13
90	0.09233	1.2	-3.05
95	0.07941	1.3	-2.97
100	0.06857	1.5	-2.90
105	0.05942	1.6	-2.83
110	0.05167	1.7	-2.76
115	0.04509	1.8	-2.69
120	0.03948	2.0	-2.62
125	0.03467	2.1	-2.56
130	0.03055	2.2	-2.50
135	0.02699	2.3	-2.44
140	0.02392	2.5	-2.39
145	0.02125	2.6	-2.33
150	0.01894	2.7	-2.28

T (°C)	Material B(K)		
	MC 3910		
	R(T) / R25	TF (%)	α (%/°C)
-55	100.6	23.0	-7.56
-50	69.29	19.9	-7.27
-45	48.40	17.1	-7.00
-40	34.27	14.6	-6.75
-35	24.57	12.4	-6.50
-30	17.83	10.5	-6.27
-25	13.09	8.7	-6.05
-20	9.71	7.2	-5.84
-15	7.282	5.9	-5.64
-10	5.514	4.7	-5.45
-5	4.215	3.7	-5.27
0	3.250	2.8	-5.10
5	2.528	2.0	-4.93
10	1.982	1.4	-4.77
15	1.567	0.8	-4.62
20	1.247	0.4	-4.48
25	1.0000	0.0	-4.34
30	0.8072	0.4	-4.21
35	0.6559	0.8	-4.08
40	0.5362	1.2	-3.96
45	0.4410	1.7	-3.85
50	0.3647	2.2	-3.74
55	0.3033	2.8	-3.63
60	0.2535	3.4	-3.53
65	0.2130	4.0	-3.43
70	0.1798	4.6	-3.34
75	0.1525	5.2	-3.25
80	0.1300	5.9	-3.16
85	0.1112	6.6	-3.08
90	0.09552	7.3	-2.99
95	0.08239	8.0	-2.92
100	0.07133	8.7	-2.84
105	0.06199	9.4	-2.77
110	0.05406	10.1	-2.70
115	0.04731	10.9	-2.63
120	0.04153	11.6	-2.57
125	0.03658	12.3	-2.51
130	0.03231	13.1	-2.45
135	0.02863	13.8	-2.39
140	0.02544	14.6	-2.33
145	0.02267	15.3	-2.28
150	0.02025	16.1	-2.23

T (°C)	Material B(K)		
	N 4080		
	R(T) / R25	TF (%)	α (%/°C)
-55	110.1	24.0	-7.50
-50	75.89	20.7	-7.25
-45	52.97	17.8	-7.01
-40	37.42	15.2	-6.78
-35	26.75	12.9	-6.56
-30	19.33	10.9	-6.35
-25	14.11	9.1	-6.14
-20	10.41	7.5	-5.95
-15	7.758	6.1	-5.76
-10	5.834	4.9	-5.58
-5	4.426	3.8	-5.41
0	3.387	2.9	-5.24
5	2.614	2.1	-5.08
10	2.033	1.4	-4.93
15	1.593	0.9	-4.78
20	1.258	0.4	-4.64
25	1.0000	0.0	-4.51
30	0.8004	0.4	-4.37
35	0.6449	0.8	-4.25
40	0.5228	1.3	-4.13
45	0.4264	1.8	-4.01
50	0.3497	2.3	-3.90
55	0.2885	2.9	-3.79
60	0.2392	3.5	-3.68
65	0.1994	4.1	-3.58
70	0.1671	4.8	-3.49
75	0.1406	5.5	-3.39
80	0.1189	6.2	-3.30
85	0.1010	6.9	-3.22
90	0.08616	7.6	-3.13
95	0.07381	8.3	-3.05
100	0.06347	9.1	-2.97
105	0.05480	9.8	-2.90
110	0.04748	10.6	-2.83
115	0.04129	11.3	-2.76
120	0.03603	12.1	-2.69
125	0.03155	12.9	-2.62
130	0.02771	13.7	-2.56
135	0.02442	14.4	-2.50
140	0.02158	15.2	-2.44
145	0.01913	16.0	-2.38
150	0.01700	16.8	-2.33

T (°C)	Material B(K)		
	NA 4100		
	R(T) / R25	TF (%)	α (%/°C)
-55	109.5	8.0	-7.53
-50	75.44	6.9	-7.27
-45	52.64	6.0	-7.02
-40	37.19	5.1	-6.78
-35	26.59	4.3	-6.56
-30	19.22	3.7	-6.34
-25	14.05	3.1	-6.14
-20	10.37	2.5	-5.94
-15	7.730	2.1	-5.75
-10	5.817	1.6	-5.57
-5	4.417	1.3	-5.40
0	3.382	1.0	-5.23
5	2.611	0.7	-5.08
10	2.032	0.5	-4.92
15	1.593	0.3	-4.78
20	1.258	0.1	-4.64
25	1.0000	0.0	-4.51
30	0.8003	0.1	-4.38
35	0.6446	0.3	-4.25
40	0.5224	0.4	-4.14
45	0.4258	0.6	-4.02
50	0.3490	0.8	-3.91
55	0.2877	1.0	-3.81
60	0.2383	1.2	-3.71
65	0.1984	1.4	-3.61
70	0.1660	1.6	-3.51
75	0.1395	1.8	-3.42
80	0.1178	2.1	-3.34
85	0.09989	2.3	-3.25
90	0.08506	2.5	-3.17
95	0.07271	2.8	-3.09
100	0.06240	3.0	-3.02
105	0.05375	3.3	-2.94
110	0.04647	3.5	-2.87
115	0.04032	3.8	-2.81
120	0.03509	4.1	-2.74
125	0.03065	4.3	-2.68
130	0.02685	4.6	-2.61
135	0.02359	4.8	-2.55
140	0.02079	5.1	-2.50
145	0.01837	5.4	-2.44
150	0.01628	5.6	-2.39

Tables of Resistance vs Temperature

T (°C)	Material B(K)		
	NC 4080		
	R(T) / R25	TF (%)	α (%/°C)
-55	105.4	24.0	-7.45
-50	72.89	20.7	-7.20
-45	51.04	17.8	-6.95
-40	36.18	15.2	-6.72
-35	25.94	12.9	-6.50
-30	18.81	10.9	-6.29
-25	13.78	9.1	-6.08
-20	10.20	7.5	-5.89
-15	7.621	6.1	-5.71
-10	5.748	4.9	-5.53
-5	4.373	3.8	-5.36
0	3.355	2.9	-5.20
5	2.595	2.1	-5.04
10	2.023	1.4	-4.89
15	1.588	0.9	-4.75
20	1.256	0.4	-4.61
25	1.000	0.0	-4.48
30	0.8014	0.4	-4.35
35	0.6463	0.8	-4.23
40	0.5243	1.3	-4.11
45	0.4278	1.8	-4.00
50	0.3510	2.3	-3.89
55	0.2896	2.9	-3.79
60	0.2401	3.5	-3.69
65	0.2001	4.1	-3.59
70	0.1675	4.8	-3.50
75	0.1409	5.5	-3.41
80	0.1190	6.2	-3.32
85	0.1010	6.9	-3.24
90	0.08605	7.6	-3.16
95	0.07360	8.3	-3.08
100	0.06319	9.1	-3.01
105	0.05446	9.8	-2.94
110	0.04710	10.6	-2.87
115	0.04087	11.3	-2.80
120	0.03559	12.1	-2.73
125	0.03109	12.9	-2.67
130	0.02724	13.7	-2.61
135	0.02394	14.4	-2.55
140	0.02111	15.2	-2.49
145	0.01866	16.0	-2.44
150	0.01654	16.8	-2.38

T (°C)	Material B(K)		
	NE 4100		
	R(T) / R25	TF (%)	α (%/°C)
-55	97.27	24.1	-7.2
-50	67.99	20.8	-7.0
-45	48.08	17.9	-6.8
-40	34.39	15.3	-6.5
-35	24.85	13.0	-6.3
-30	18.15	11.0	-6.1
-25	13.38	9.2	-6.0
-20	9.960	7.6	-5.8
-15	7.479	6.2	-5.6
-10	5.664	4.9	-5.4
-5	4.325	3.8	-5.3
0	3.328	2.9	-5.1
5	2.581	2.1	-5.0
10	2.016	1.4	-4.9
15	1.585	0.9	-4.7
20	1.255	0.4	-4.6
25	1.000	0.0	-4.5
30	0.8017	0.4	-4.3
35	0.6466	0.8	-4.2
40	0.5245	1.3	-4.1
45	0.4278	1.8	-4.0
50	0.3508	2.3	-3.9
55	0.2891	2.9	-3.8
60	0.2394	3.5	-3.7
65	0.1992	4.2	-3.6
70	0.1666	4.8	-3.5
75	0.1399	5.5	-3.4
80	0.11794	6.2	-3.4
85	0.09987	6.9	-3.3
90	0.08491	7.6	-3.2
95	0.07246	8.4	-3.1
100	0.06207	9.1	-3.1
105	0.05336	9.9	-3.0
110	0.04604	10.6	-2.9
115	0.03985	11.4	-2.8
120	0.03461	12.2	-2.8
125	0.03015	12.9	-2.7
130	0.02635	13.7	-2.7
135	0.02309	14.5	-2.6
140	0.0203	15.3	-2.5
145	0.01789	16.1	-2.5
150	0.01581	16.8	-2.4

T (°C)	Material B(K)		
	N5 4160		
	R(T) / R25	TF (%)	α (%/°C)
-55	115.8	16.3	-7.52
-50	79.72	14.1	-7.28
-45	55.54	12.1	-7.04
-40	39.15	10.4	-6.82
-35	27.91	8.8	-6.61
-30	20.11	7.4	-6.40
-25	14.64	6.2	-6.20
-20	10.77	5.1	-6.01
-15	7.996	4.2	-5.83
-10	5.991	3.3	-5.65
-5	4.529	2.6	-5.48
0	3.454	2.0	-5.31
5	2.655	1.4	-5.16
10	2.057	1.0	-5.00
15	1.606	0.6	-4.86
20	1.263	0.3	-4.72
25	1.000	0.0	-4.58
30	0.7973	0.3	-4.45
35	0.6398	0.5	-4.32
40	0.5167	0.9	-4.20
45	0.4198	1.2	-4.09
50	0.3430	1.6	-3.97
55	0.2819	2.0	-3.86
60	0.2329	2.4	-3.76
65	0.1934	2.8	-3.66
70	0.1614	3.3	-3.56
75	0.1354	3.7	-3.46
80	0.1141	4.2	-3.37
85	0.09658	4.7	-3.29
90	0.08211	5.2	-3.20
95	0.07010	5.7	-3.12
100	0.06009	6.2	-3.04
105	0.05171	6.7	-2.96
110	0.04467	7.2	-2.89
115	0.03872	7.7	-2.82
120	0.03369	8.2	-2.75
125	0.02941	8.8	-2.68
130	0.02576	9.3	-2.62
135	0.02263	9.8	-2.55
140	0.01995	10.3	-2.49
145	0.01763	10.9	-2.44
150	0.01563	11.4	-2.38

T (°C)	Material B(K)		
	P 4220		
	R(T) / R25	TF (%)	α (%/°C)
-55	121.4	24.8	-7.56
-50	83.35	21.5	-7.32
-45	57.92	18.4	-7.09
-40	40.72	15.8	-6.87
-35	28.95	13.4	-6.66
-30	20.80	11.3	-6.45
-25	15.10	9.4	-6.26
-20	11.07	7.8	-6.07
-15	8.197	6.3	-5.89
-10	6.123	5.1	-5.71
-5	4.615	4.0	-5.54
0	3.508	3.0	-5.38
5	2.688	2.2	-5.22
10	2.076	1.5	-5.07
15	1.616	0.9	-4.92
20	1.267	0.4	-4.78
25	1.000	0.0	-4.64
30	0.7949	0.4	-4.51
35	0.6359	0.8	-4.38
40	0.5120	1.3	-4.26
45	0.4148	1.8	-4.14
50	0.3379	2.4	-4.03
55	0.2769	3.0	-3.92
60	0.2281	3.6	-3.81
65	0.1890	4.3	-3.71
70	0.1573	5.0	-3.61
75	0.1316	5.7	-3.52
80	0.1106	6.4	-3.42
85	0.09337	7.1	-3.34
90	0.07918	7.9	-3.25
95	0.06743	8.6	-3.17
100	0.05766	9.4	-3.09
105	0.04950	10.2	-3.01
110	0.04266	10.9	-2.93
115	0.03691	11.7	-2.86
120	0.03204	12.5	-2.79
125	0.02791	13.3	-2.72
130	0.02439	14.1	-2.66
135	0.02139	14.9	-2.59
140	0.01881	15.7	-2.53
145	0.01660	16.5	-2.47
150	0.01469	17.3	-2.42

T (°C)	Material B(K)		
	PA 4235		
	R(T) / R25	TF (%)	α (%/°C)
-55	123.39	8.3	-7.68
-50	84.33	7.2	-7.42
-45	58.39	6.2	-7.17
-40	40.93	5.3	-6.93
-35	29.04	4.5	-6.71
-30	20.83	3.8	-6.49
-25	15.11	3.2	-6.29
-20	11.07	2.6	-6.09
-15	8.190	2.1	-5.90
-10	6.117	1.7	-5.72
-5	4.610	1.3	-5.54
0	3.505	1.0	-5.38
5	2.686	0.7	-5.22
10	2.075	0.5	-5.07
15	1.615	0.3	-4.92
20	1.267	0.1	-4.78
25	1.000	0.0	-4.64
30	0.7949	0.1	-4.51
35	0.6359	0.3	-4.39
40	0.5119	0.4	-4.27
45	0.4145	0.6	-4.15
50	0.3376	0.8	-4.04
55	0.2764	1.0	-3.93
60	0.2276	1.2	-3.83
65	0.1883	1.4	-3.73
70	0.1566	1.7	-3.63
75	0.1308	1.9	-3.54
80	0.1098	2.1	-3.45
85	0.09257	2.4	-3.37
90	0.07836	2.6	-3.28
95	0.06661	2.9	-3.20
100	0.05685	3.1	-3.13
105	0.04870	3.4	-3.05
110	0.04188	3.7	-2.98
115	0.03614	3.9	-2.91
120	0.03129	4.2	-2.84
125	0.02719	4.5	-2.78
130	0.02370	4.7	-2.71
135	0.02072	5.0	-2.65
140	0.01817	5.3	-2.59
145	0.01598	5.5	-2.54
150	0.01409	5.8	-2.48

T (°C)	Material B(K)		
	Q 4300		
	R(T) / R25	TF (%)	α (%/°C)
-55	98.04	25.3	-6.87
-50	69.53	21.9	-6.70
-45	49.73	18.8	-6.53
-40	35.87	16.1	-6.37
-35	26.08	13.6	-6.22
-30	19.12	11.5	-6.07
-25	14.12	9.6	-5.92
-20	10.51	7.9	-5.78
-15	7.877	6.5	-5.64
-10	5.947	5.2	-5.50
-5	4.521	4.0	-5.37
0	3.460	3.1	-5.24
5	2.666	2.2	-5.11
10	2.067	1.5	-4.99
15	1.613	0.9	-4.87
20	1.266	0.4	-4.75
25	1.000	0.0	-4.63
30	0.7944	0.4	-4.52
35	0.6347	0.8	-4.41
40	0.5099	1.3	-4.30
45	0.4119	1.9	-4.20
50	0.3344	2.4	-4.09
55	0.2730	3.1	-3.99
60	0.2239	3.7	-3.90
65	0.1846	4.4	-3.80
70	0.1529	5.1	-3.71
75	0.1272	5.8	-3.62
80	0.1063	6.5	-3.53
85	0.08927	7.2	-3.44
90	0.07526	8.0	-3.36
95	0.06372	8.8	-3.28
100	0.05417	9.6	-3.20
105	0.04622	10.4	-3.13
110	0.03960	11.2	-3.05
115	0.03405	12.0	-2.98
120	0.02938	12.8	-2.91
125	0.02545	13.6	-2.84
130	0.02211	14.4	-2.77
135	0.01928	15.2	-2.71
140	0.01686	16.0	-2.64
145	0.01479	16.8	-2.58
150	0.01302	17.7	-2.52

Tables of Resistance vs Temperature



T (°C)	Material B(K)		
	QA 4250		
	R(T) / R25	TF (%)	α (%/°C)
-55	99.06	8.3	-7.09
-50	69.60	7.2	-6.88
-45	49.42	6.2	-6.68
-40	35.45	5.3	-6.49
-35	25.67	4.5	-6.30
-30	18.77	3.8	-6.13
-25	13.84	3.2	-5.96
-20	10.29	2.6	-5.79
-15	7.719	2.1	-5.64
-10	5.834	1.7	-5.49
-5	4.442	1.3	-5.34
0	3.407	1.0	-5.20
5	2.632	0.7	-5.07
10	2.047	0.5	-4.94
15	1.602	0.3	-4.81
20	1.262	0.1	-4.69
25	1.0000	0.0	-4.57
30	0.7971	0.1	-4.46
35	0.6389	0.3	-4.35
40	0.5149	0.4	-4.24
45	0.4172	0.6	-4.14
50	0.3397	0.8	-4.04
55	0.2780	1.0	-3.95
60	0.2286	1.2	-3.85
65	0.1888	1.4	-3.76
70	0.1567	1.7	-3.68
75	0.1306	1.9	-3.59
80	0.1093	2.1	-3.51
85	0.09179	2.4	-3.43
90	0.07743	2.6	-3.36
95	0.06556	2.9	-3.28
100	0.05571	3.2	-3.21
105	0.04752	3.4	-3.14
110	0.04067	3.7	-3.07
115	0.03492	3.9	-3.01
120	0.03008	4.2	-2.94
125	0.02600	4.5	-2.88
130	0.02254	4.7	-2.82
135	0.01960	5.0	-2.76
140	0.01709	5.3	-2.71
145	0.01495	5.5	-2.65
150	0.01311	5.8	-2.60

T (°C)	Material B(K)		
	R 4400		
	R(T) / R25	TF (%)	α (%/°C)
-55	113.9	25.9	-7.13
-50	79.71	22.4	-6.95
-45	56.30	19.2	-6.77
-40	40.13	16.4	-6.60
-35	28.85	14.0	-6.44
-30	20.92	11.8	-6.28
-25	15.29	9.8	-6.12
-20	11.27	8.1	-5.97
-15	8.368	6.6	-5.82
-10	6.261	5.3	-5.68
-5	4.719	4.1	-5.53
0	3.583	3.1	-5.40
5	2.739	2.3	-5.26
10	2.108	1.5	-5.13
15	1.634	0.9	-5.00
20	1.274	0.4	-4.88
25	1.0000	0.0	-4.75
30	0.7897	0.4	-4.64
35	0.6273	0.9	-4.52
40	0.5012	1.4	-4.41
45	0.4028	1.9	-4.30
50	0.3255	2.5	-4.19
55	0.2644	3.1	-4.09
60	0.2159	3.8	-3.98
65	0.1772	4.5	-3.89
70	0.1462	5.2	-3.79
75	0.1212	5.9	-3.70
80	0.1009	6.7	-3.60
85	0.08440	7.4	-3.52
90	0.07092	8.2	-3.43
95	0.05984	9.0	-3.35
100	0.05071	9.8	-3.26
105	0.04314	10.6	-3.19
110	0.03685	11.4	-3.11
115	0.03160	12.2	-3.03
120	0.02719	13.1	-2.96
125	0.02349	13.9	-2.89
130	0.02036	14.7	-2.82
135	0.01770	15.6	-2.76
140	0.01545	16.4	-2.69
145	0.01352	17.2	-2.63
150	0.01187	18.1	-2.57

T (°C)	Material B(K)		
	RA 4380		
	R(T) / R25	TF (%)	α (%/°C)
-55	110.76	8.6	-7.24
-50	77.24	7.4	-7.03
-45	54.44	6.4	-6.83
-40	38.76	5.5	-6.63
-35	27.87	4.6	-6.45
-30	20.22	3.9	-6.27
-25	14.81	3.3	-6.10
-20	10.94	2.7	-5.93
-15	8.144	2.2	-5.78
-10	6.112	1.8	-5.62
-5	4.623	1.4	-5.48
0	3.522	1.0	-5.34
5	2.702	0.8	-5.20
10	2.087	0.5	-5.07
15	1.623	0.3	-4.94
20	1.270	0.1	-4.82
25	1.0000	0.0	-4.70
30	0.7920	0.1	-4.59
35	0.6308	0.3	-4.47
40	0.5052	0.5	-4.37
45	0.4068	0.6	-4.26
50	0.3292	0.8	-4.16
55	0.2678	1.0	-4.07
60	0.2189	1.3	-3.97
65	0.1797	1.5	-3.88
70	0.1482	1.7	-3.79
75	0.1228	2.0	-3.71
80	0.1022	2.2	-3.63
85	0.08536	2.5	-3.55
90	0.07159	2.7	-3.47
95	0.06028	3.0	-3.39
100	0.05095	3.2	-3.32
105	0.04322	3.5	-3.25
110	0.03679	3.8	-3.18
115	0.03142	4.1	-3.11
120	0.02693	4.3	-3.05
125	0.02315	4.6	-2.98
130	0.01997	4.9	-2.92
135	0.01728	5.2	-2.86
140	0.01499	5.4	-2.80
145	0.01304	5.7	-2.75
150	0.01138	6.0	-2.69

T (°C)	Material B(K)		
	RC 4340		
	R(T) / R25	TF (%)	α (%/°C)
-55	105.88	25.5	-7.15
-50	74.01	22.1	-6.95
-45	52.37	19.0	-6.75
-40	37.43	16.2	-6.56
-35	27.01	13.8	-6.38
-30	19.66	11.6	-6.20
-25	14.44	9.7	-6.04
-20	10.70	8.0	-5.87
-15	7.990	6.5	-5.72
-10	6.013	5.2	-5.57
-5	4.559	4.1	-5.42
0	3.482	3.1	-5.29
5	2.678	2.2	-5.15
10	2.074	1.5	-5.02
15	1.616	0.9	-4.90
20	1.267	0.4	-4.77
25	1.0000	0.0	-4.66
30	0.7936	0.4	-4.54
35	0.6334	0.8	-4.43
40	0.5083	1.3	-4.33
45	0.4100	1.9	-4.23
50	0.3325	2.5	-4.13
55	0.2709	3.1	-4.03
60	0.2218	3.7	-3.94
65	0.1825	4.4	-3.85
70	0.1508	5.1	-3.76
75	0.1251	5.8	-3.67
80	0.1043	6.6	-3.59
85	0.08727	7.3	-3.51
90	0.07332	8.1	-3.43
95	0.06184	8.9	-3.36
100	0.05235	9.7	-3.29
105	0.04448	10.5	-3.22
110	0.03793	11.3	-3.15
115	0.03245	12.1	-3.08
120	0.02785	12.9	-3.01
125	0.02399	13.7	-2.95
130	0.02072	14.5	-2.89
135	0.01796	15.4	-2.83
140	0.01561	16.2	-2.77
145	0.01360	17.0	-2.72
150	0.01189	17.8	-2.66

T (°C)	Material B(K)		
	S 4520		
	R(T) / R25	TF (%)	α (%/°C)
-55	126.1	26.6	-7.25
-50	87.75	23.0	-7.07
-45	61.60	19.8	-6.90
-40	43.63	16.9	-6.73
-35	31.17	14.3	-6.56
-30	22.46	12.1	-6.40
-25	16.31	10.1	-6.25
-20	11.94	8.3	-6.10
-15	8.809	6.8	-5.95
-10	6.549	5.4	-5.80
-5	4.904	4.2	-5.66
0	3.699	3.2	-5.52
5	2.810	2.3	-5.39
10	2.149	1.6	-5.26
15	1.654	1.0	-5.13
20	1.282	0.4	-5.00
25	1.0000	0.0	-4.88
30	0.7848	0.4	-4.76
35	0.6196	0.9	-4.64
40	0.4921	1.4	-4.52
45	0.3931	2.0	-4.41
50	0.3158	2.6	-4.30
55	0.2551	3.2	-4.20
60	0.2072	3.9	-4.09
65	0.1691	4.6	-3.99
70	0.1387	5.3	-3.89
75	0.1144	6.1	-3.80
80	0.0948	6.8	-3.71
85	0.0789	7.6	-3.61
90	0.06594	8.4	-3.53
95	0.05538	9.2	-3.44
100	0.04671	10.1	-3.36
105	0.03956	10.9	-3.28
110	0.03364	11.7	-3.20
115	0.02872	12.6	-3.12
120	0.02461	13.4	-3.04
125	0.02117	14.3	-2.97
130	0.01827	15.1	-2.90
135	0.01583	16.0	-2.83
140	0.01376	16.8	-2.77
145	0.01200	17.7	-2.70
150	0.01050	18.6	-2.64

T (°C)	Material B(K)		
	SC 4500		
	R(T) / R25	TF (%)	α (%/°C)
-55	129.77	26.5	-7.51
-50	89.31	22.9	-7.29
-45	62.15	19.7	-7.07
-40	43.72	16.8	-6.87
-35	31.07	14.3	-6.68
-30	22.29	12.0	-6.49
-25	16.15	10.0	-6.31
-20	11.80	8.3	-6.14
-15	8.703	6.8	-5.97
-10	6.470	5.4	-5.81
-5	4.849	4.2	-5.66
0	3.662	3.2	-5.51
5	2.786	2.3	-5.36
10	2.135	1.6	-5.23
15	1.647	0.9	-5.09
20	1.279	0.4	-4.96
25	1.0000	0.0	-4.84
30	0.7865	0.4	-4.72
35	0.6223	0.9	-4.60
40	0.4953	1.4	-4.49
45	0.3963	2.0	-4.38
50	0.3189	2.6	-4.28
55	0.2579	3.2	-4.18
60	0.2096	3.9	-4.08
65	0.1712	4.6	-3.99
70	0.1405	5.3	-3.89
75	0.1159	6.0	-3.80
80	0.09595	6.8	-3.72
85	0.07980	7.6	-3.63
90	0.06664	8.4	-3.55
95	0.05588	9.2	-3.47
100	0.04704	10.0	-3.40
105	0.03975	10.8	-3.32
110	0.03371	11.7	-3.25
115	0.02869	12.5	-3.18
120	0.02450	13.4	-3.12
125	0.02100	14.2	-3.05
130	0.01805	15.1	-2.99
135	0.01557	15.9	-2.92
140	0.01347	16.8	-2.86
145	0.01169	17.6	-2.80
150	0.01017	18.5	-2.75



Tables of Resistance vs Temperature

T (°C)	Material B(K)		
	T 4630		
	R(T) / R25	TF (%)	α (%/°C)
-55	137.06	27.2	-7.33
-50	94.94	23.5	-7.15
-45	66.35	20.2	-6.98
-40	46.78	17.3	-6.82
-35	33.25	14.7	-6.66
-30	23.84	12.4	-6.50
-25	17.23	10.3	-6.35
-20	12.54	8.5	-6.20
-15	9.206	6.9	-6.05
-10	6.807	5.6	-5.91
-5	5.070	4.3	-5.77
0	3.803	3.3	-5.63
5	2.873	2.4	-5.50
10	2.185	1.6	-5.36
15	1.673	1.0	-5.23
20	1.289	0.4	-5.11
25	1.0000	0.0	-4.99
30	0.7805	0.4	-4.86
35	0.6129	0.9	-4.75
40	0.4841	1.4	-4.63
45	0.3847	2.0	-4.52
50	0.3074	2.6	-4.41
55	0.2470	3.3	-4.30
60	0.1996	4.0	-4.19
65	0.1621	4.7	-4.09
70	0.1323	5.4	-3.99
75	0.1086	6.2	-3.89
80	0.08951	7.0	-3.80
85	0.07416	7.8	-3.71
90	0.06172	8.6	-3.62
95	0.05160	9.5	-3.53
100	0.04333	10.3	-3.44
105	0.03655	11.2	-3.36
110	0.03095	12.0	-3.28
115	0.02632	12.9	-3.20
120	0.02246	13.7	-3.12
125	0.01925	14.6	-3.05
130	0.01656	15.5	-2.97
135	0.01429	16.4	-2.90
140	0.01238	17.3	-2.83
145	0.01076	18.1	-2.77
150	0.009383	19.0	-2.70

T (°C)	Material B(K)		
	U 4840		
	R(T) / R25	TF (%)	α (%/°C)
-55	173.74	28.5	-7.69
-50	118.20	24.6	-7.50
-45	81.18	21.2	-7.32
-40	56.26	18.1	-7.15
-35	39.34	15.4	-6.98
-30	27.75	12.9	-6.82
-25	19.74	10.8	-6.66
-20	14.15	8.9	-6.50
-15	10.23	7.3	-6.34
-10	7.457	5.8	-6.19
-5	5.476	4.5	-6.04
0	4.051	3.4	-5.90
5	3.020	2.5	-5.76
10	2.267	1.7	-5.62
15	1.714	1.0	-5.48
20	1.305	0.5	-5.35
25	1.0000	0.0	-5.22
30	0.7715	0.4	-5.09
35	0.5991	0.9	-4.97
40	0.4681	1.5	-4.84
45	0.3680	2.1	-4.72
50	0.2911	2.8	-4.61
55	0.2316	3.4	-4.49
60	0.1853	4.2	-4.38
65	0.1491	4.9	-4.28
70	0.1206	5.7	-4.17
75	0.09812	6.5	-4.07
80	0.08022	7.3	-3.97
85	0.06591	8.2	-3.87
90	0.05442	9.0	-3.77
95	0.04515	9.9	-3.68
100	0.03763	10.8	-3.59
105	0.03150	11.7	-3.50
110	0.02649	12.6	-3.42
115	0.02237	13.5	-3.33
120	0.01897	14.4	-3.25
125	0.01615	15.3	-3.17
130	0.01380	16.2	-3.10
135	0.01184	17.1	-3.02
140	0.01020	18.0	-2.95
145	0.008814	19.0	-2.88
150	0.007643	19.9	-2.81