

# SPECIFICATION

Part No. : **CA.25**

Product Name : 2.4/5 GHz Dual-Band Wi-Fi Dielectric Loop Antenna

Feature : Smallest 2400MHz to 2500MHz/5150MHz to 5850MHz  
Dual-Band SMT Type Antenna  
Ultra Low profile 3.05mm x 1.6mm x 0.55mm  
Supports IEEE 802.11 a/b/g/n and ac Dual-Band WIFI systems  
Linear Polarization  
Tuned on 40\*80mm ground plane  
**RoHS Compliant**

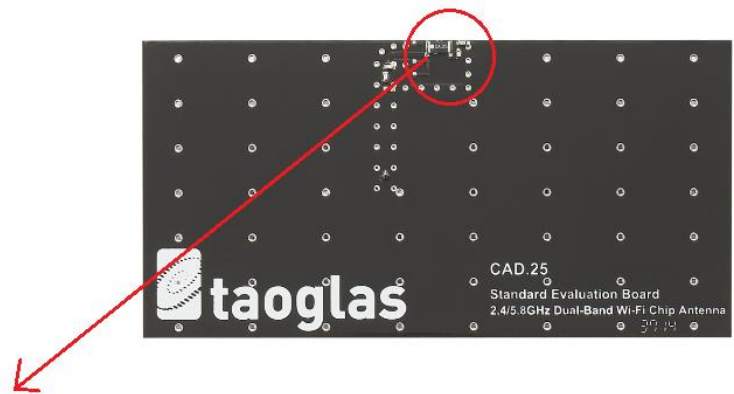

## 1. Introduction

The CA.25 is a super small SMT ceramic loop antenna for 2400MHz to 2500MHz/ 5150MHz to 5850MHz dual band that includes Bluetooth, WIFI, Zigbee, and ISM applications. The CA.25 has a peak gain of 1.0 dBi and 1.5 dBi at 2.4GHz and 5.5GHz, respectively, with an efficiency of at least 60%. This antenna is delivered on tape and reel.

The CA.25 antenna has an ultra-low profile form factor of 3.05mm x 1.6mm x 0.55mm and allows use on extremely thin devices while still maintaining excellent RF performance characteristics. All that is needed is a 50 Ohm transmission line to the module.

Typical applications include:

- USB dongles
- Tablets
- Home and industrial in-wall WIFI automation
- Hand-held devices

Many module manufacturers specify peak gain limits for any antennas that are to be connected to that module. Those peak gain limits are based on free-space conditions. In practice, the peak gain of an antenna tested in free-space can degrade by at least 1 or 2dBi when put inside a device. So ideally you should go for a slightly higher peak gain antenna than mentioned on the module specification to compensate for this effect, giving you better performance.

Upon testing of any of our antennas with your device and a selection of appropriate layout, integration technique, or cable, Taoglas can make sure any



of our antennas' peak gain will be below the peak gain limits. Taoglas can then issue a specification and/or report for the selected antenna in your device that will clearly show it complying with the peak gain limits, so you can be assured you are meeting regulatory requirements for that module.

For example, a module manufacturer may state that the antenna must have less than 2dBi peak gain, but you don't need to select an embedded antenna that has a peak gain of less than 2dBi in free-space. This will give you a less optimized solution. It is better to go for a slightly higher free-space peak gain of 3dBi or more if available. Once that antenna gets integrated into your device, performance will degrade below this 2dBi peak gain due to the effects of GND plane, surrounding components, and device housing. If you want to be absolutely sure, contact Taoglas and we will test. Choosing a Taoglas antenna with a higher peak gain than what is specified by the module manufacturer and enlisting our help will ensure you are getting the best performance possible without exceeding the peak gain limits.

Custom tuned versions for different ground-planes and housing environments can be made subject to a minimum order quantity.

Contact your regional Taoglas sales office for support to integrate and test this antenna performance in your device.

CA.25 also has GPS/Glonass/Beidou functionality, if client follows our specific matching circuit components on their main board, it can be re-tuned to work as an embedded GNSS antenna. Please kindly refer to our specification AGGBLA.03.07.0095A.

## 2. Specification Table

Parameter	Specification	
Working Frequency	2400~2500 MHz	5150~5850 MHz
VSWR	3.0	3.0
Peak Gain	0.5 dBi	3.3 dBi
Efficiency(Peak)	60%	70%
Polarization	Linear	
Impedance	50 Ohm	
Weight	9mg	
Dimensions	3.05 x 1.6 x 0.55 mm	
Operating Temperature	-40 to +85C	

\* These values are based on our standard 40mmx80mm test board. Actual electrical values will change depending on ground plane size, shape, mounting position, matching circuit design, and surrounding environment.

### 3. Test Setup

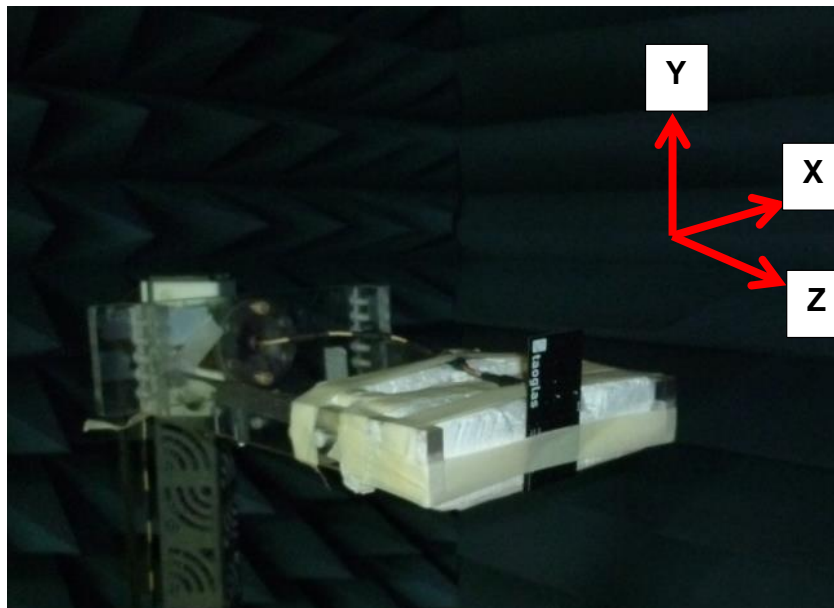
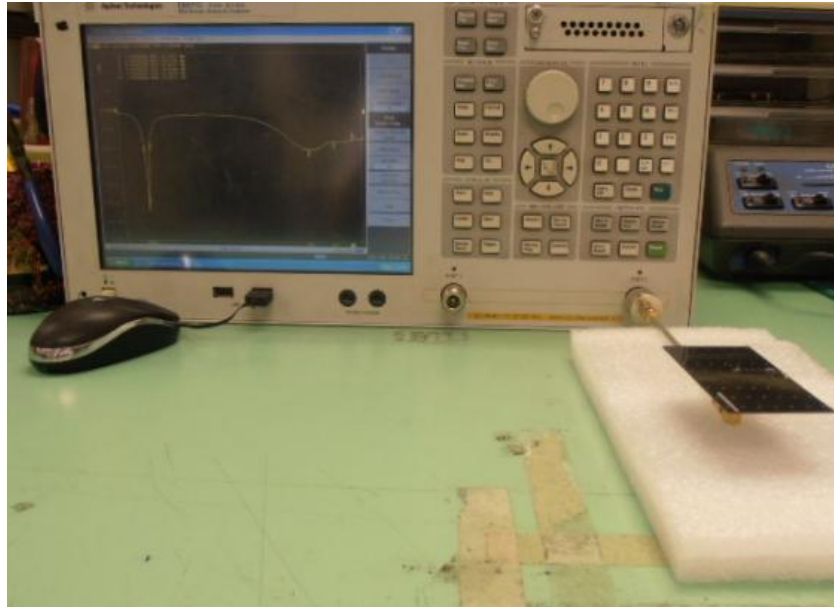

## 4. Electrical Specifications

### 4.1 Return Loss

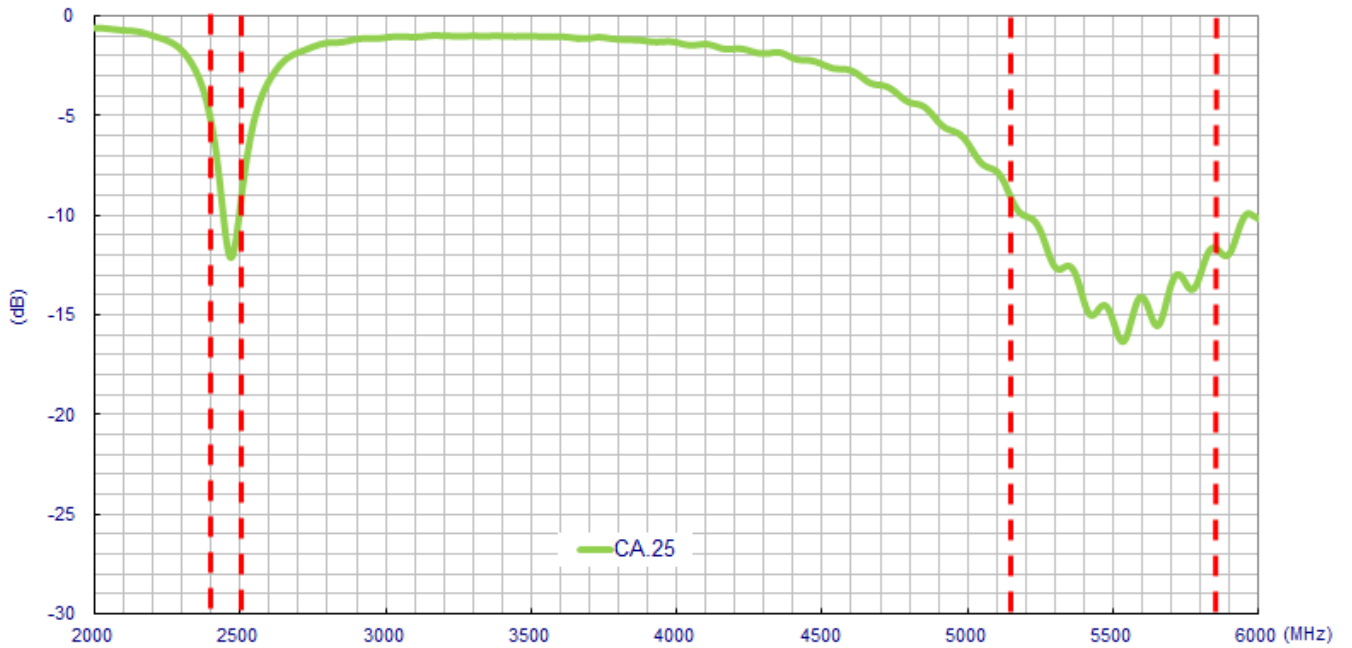

Return Loss	2400MHz	2450MHz	2500MHz	5150MHz	5550MHz	5850MHz
S11(dB)	-6.0	-11.0	-9.5	-9.1	-15.9	-11.6

## 4.2 Efficiency

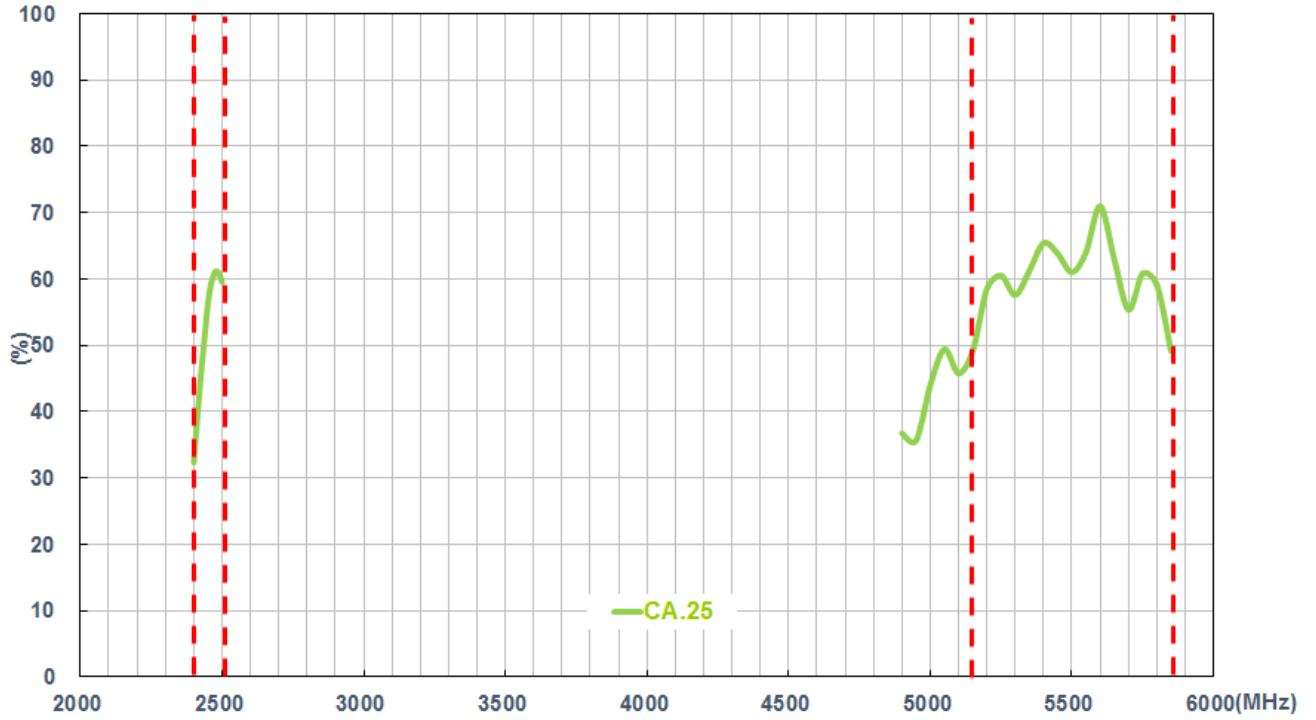

WLAN	2400MHz	2450MHz	2500MHz	5150MHz	5550MHz	5850MHz
Efficiency	32.30%	56.37%	59.48%	49.10%	61.01%	49.10%

### 4.3 Average Gain

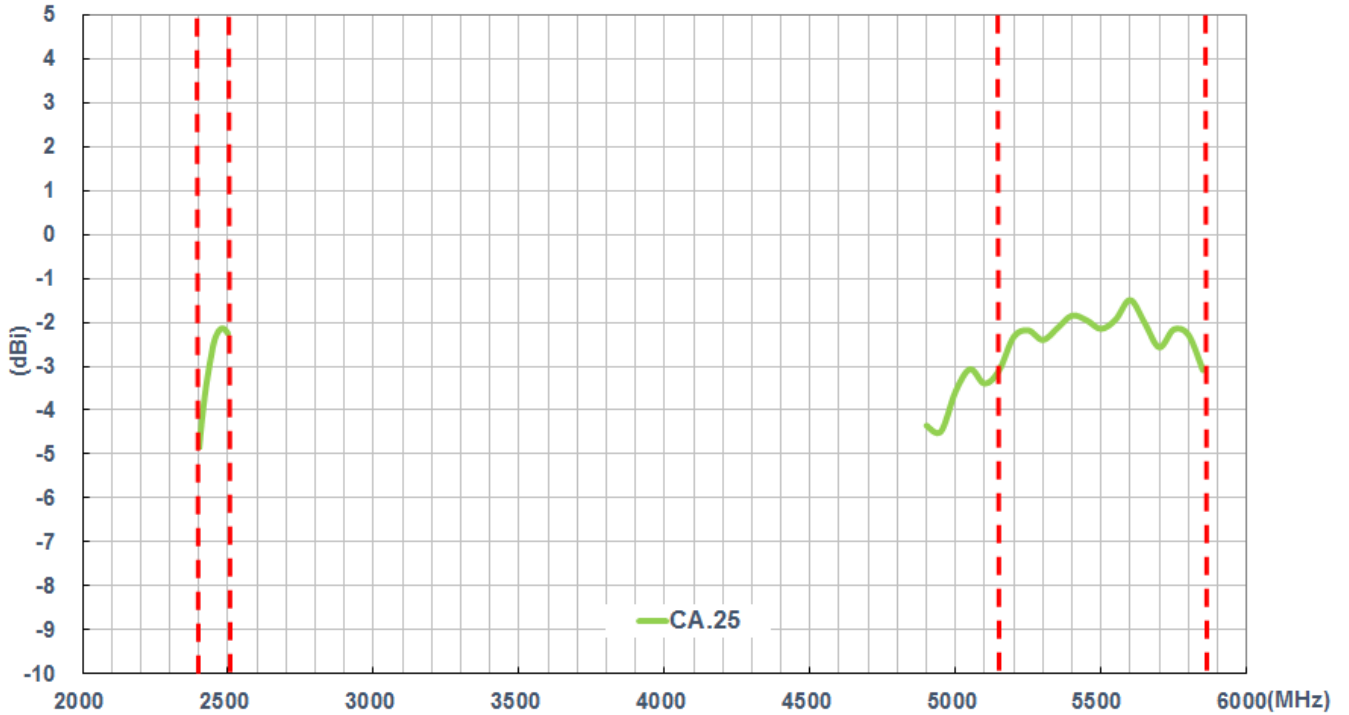

WLAN	2400MHz	2450MHz	2500MHZ	5150MHz	5550MHz	5850MHz
Average (dBi)	-4.90	-2.48	-2.25	-3.08	-1.93	-3.08



### 4.4 Peak Gain

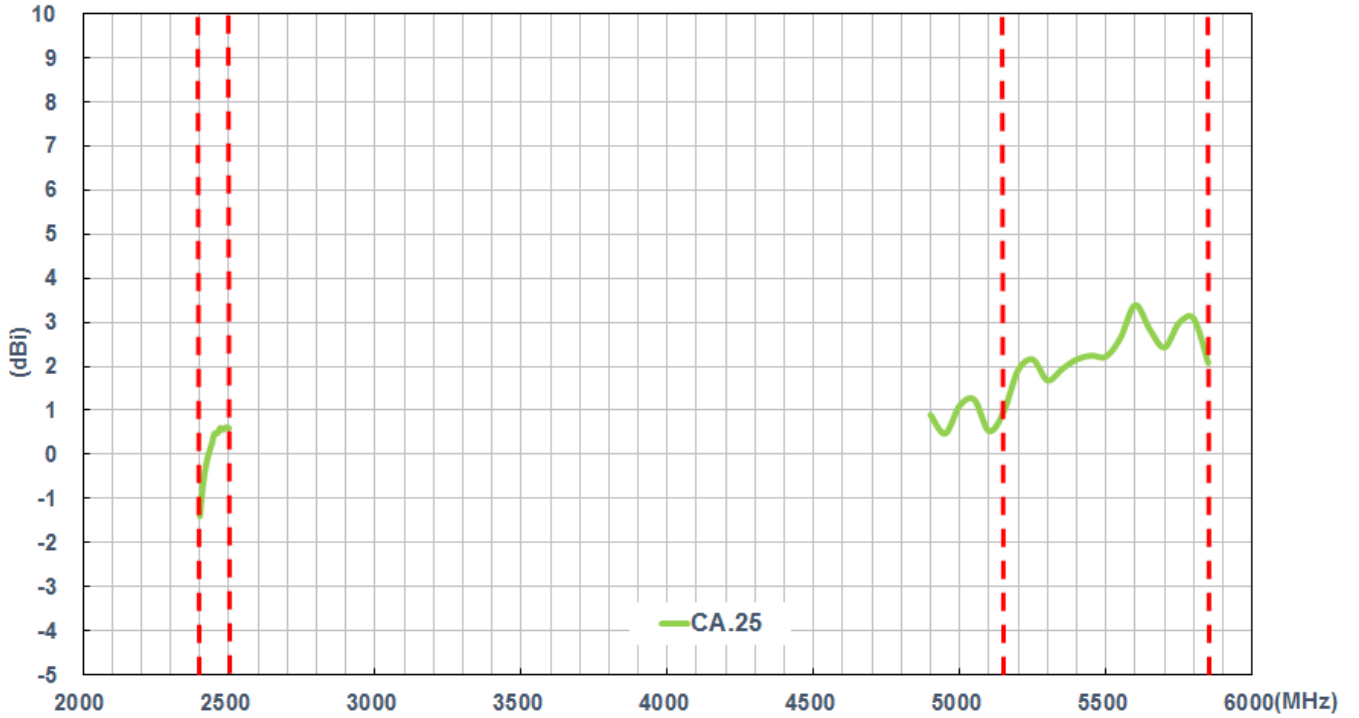

WLAN	2400MHz	2450MHz	2500MHZ	5150MHz	5550MHz	5850MHz
Peak (dBi)	-1.39	0.47	0.59	0.96	2.64	2.07

## 4.5 2D Radiation Pattern

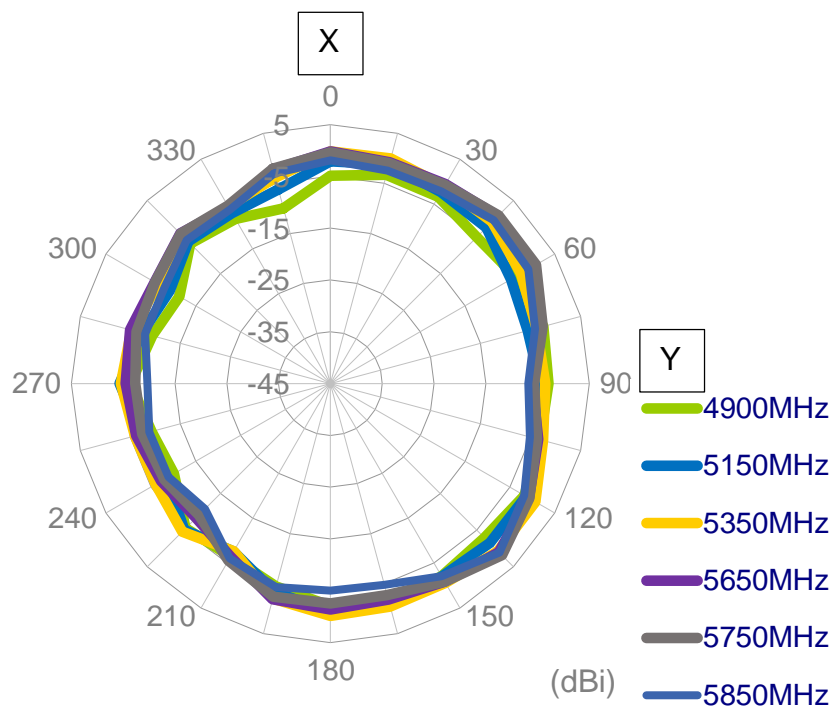
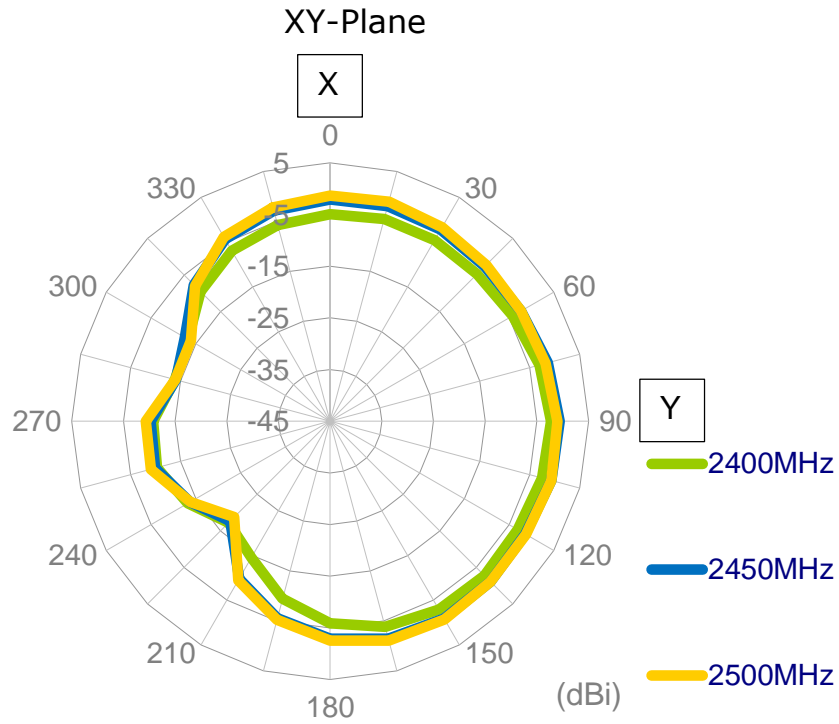

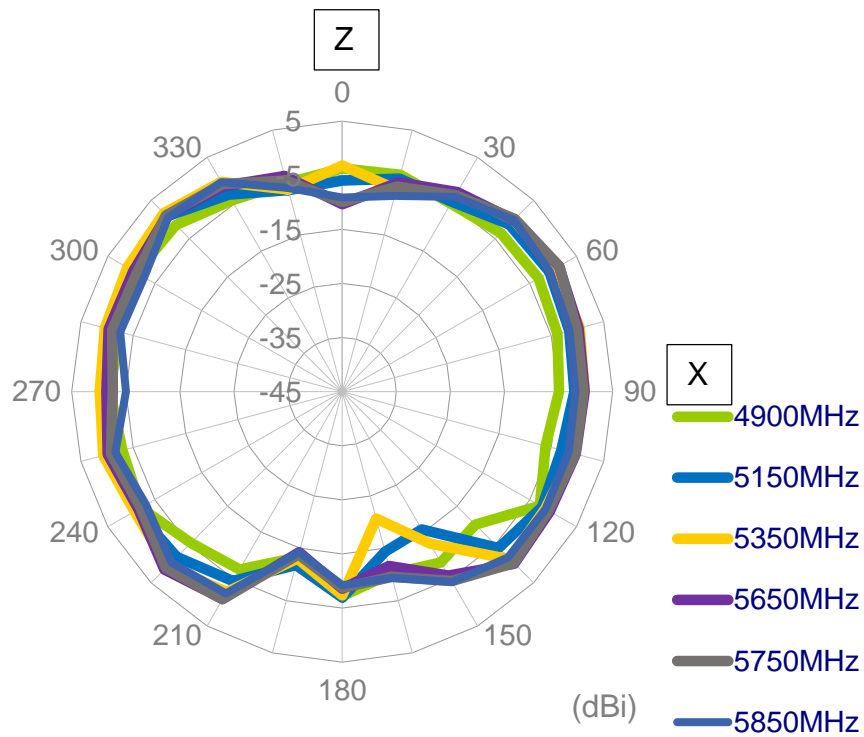
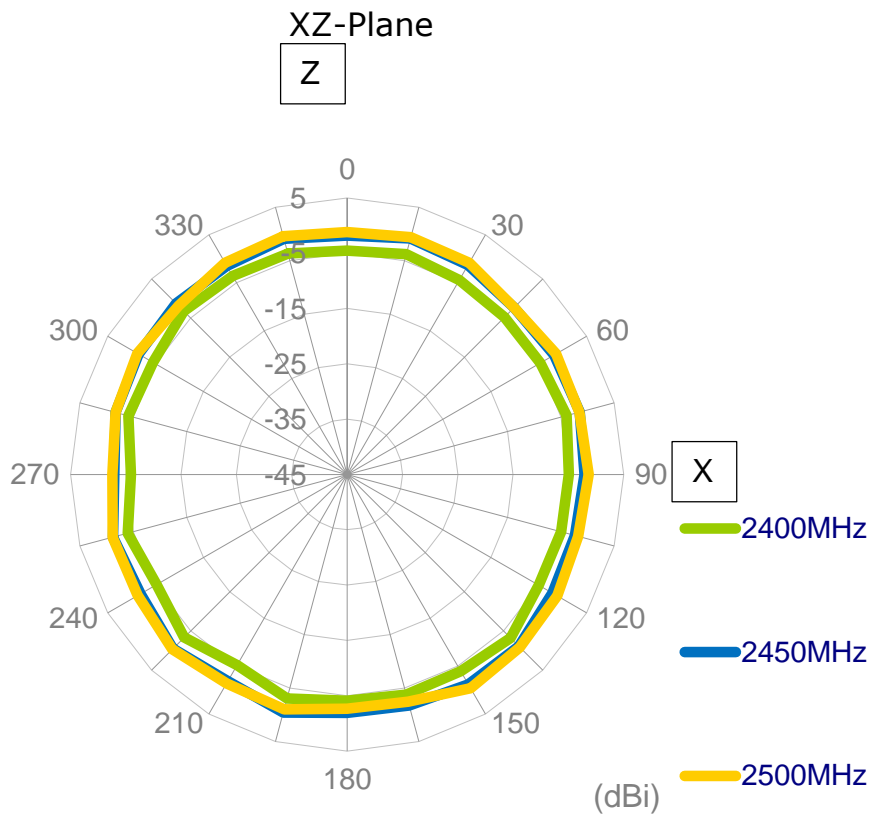

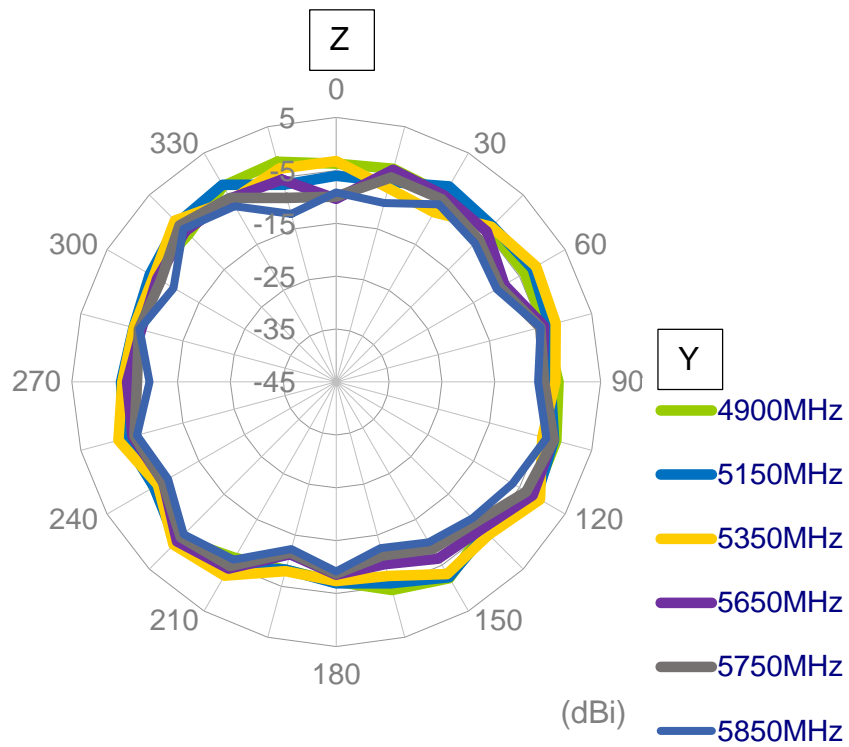
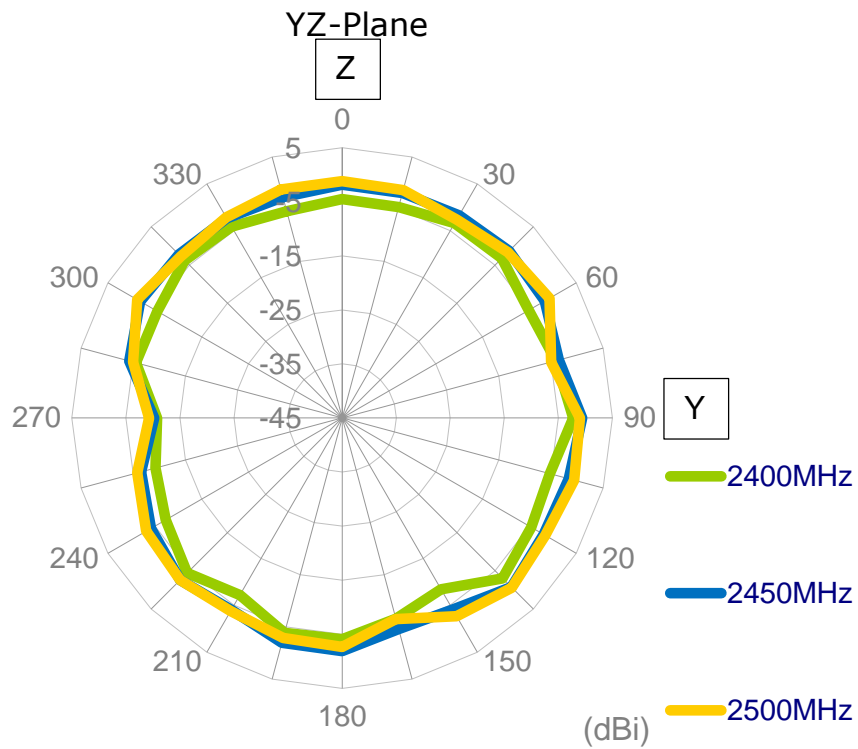

### 4.6 3D Radiation Pattern

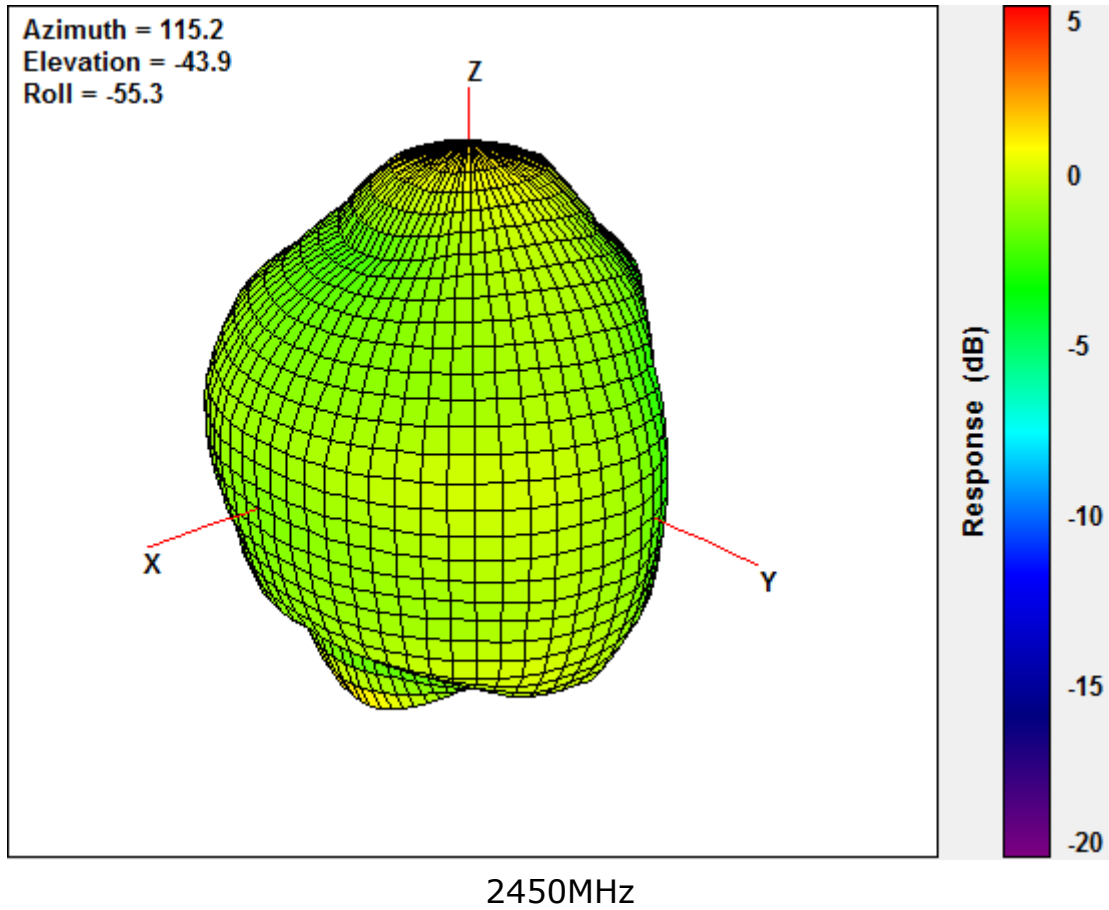

## 5. Footprint Layout Guide

### 5.1 Top Copper

All pads should be connected to GND.

Pad 1 should be connected to a 50 ohm transmission line.

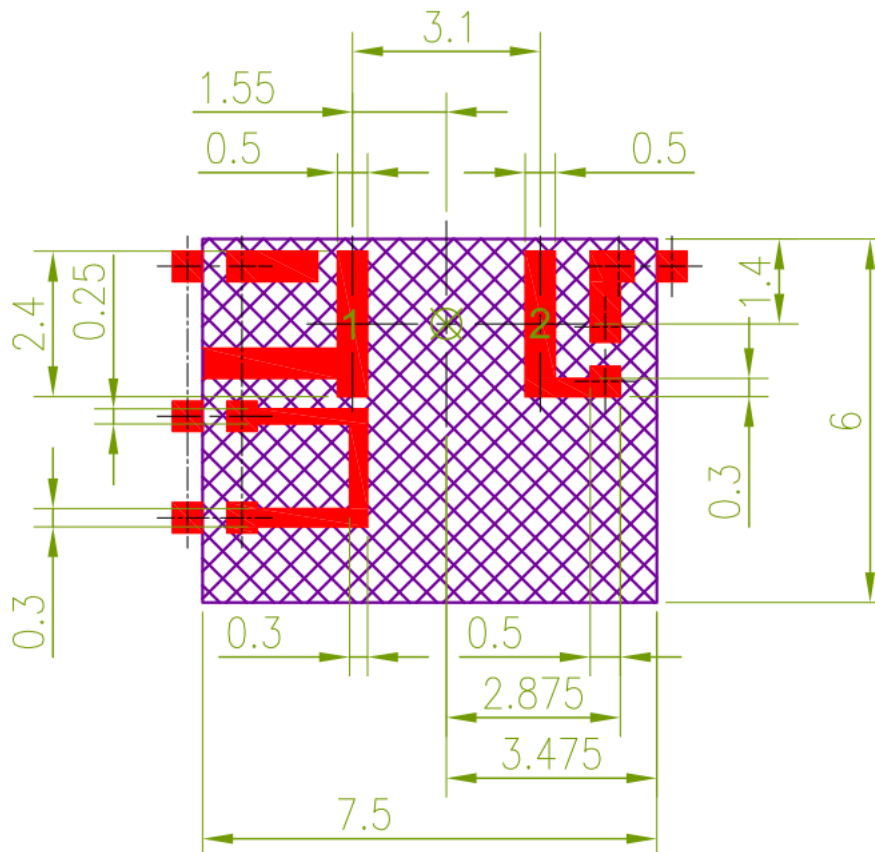

**NOTE:**



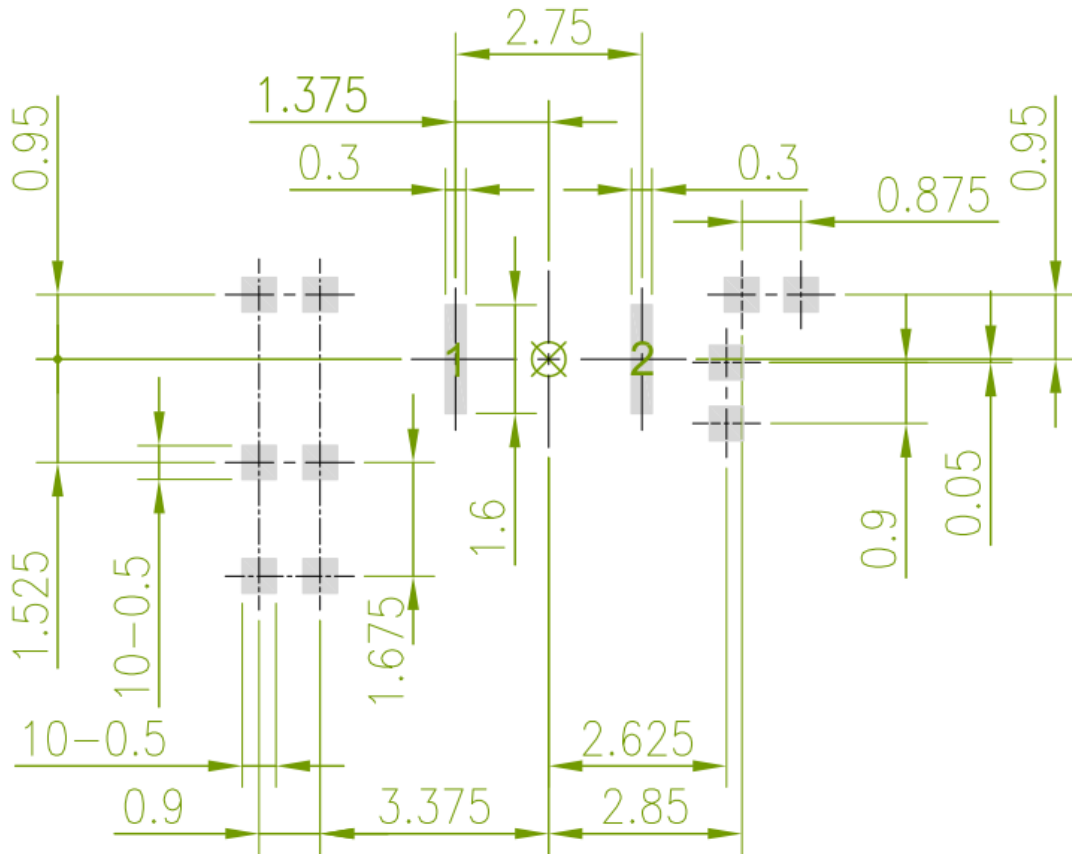

- 1. EN/IG area 
- 2. Solder Mask area 
- 3. Copper area 
- 4. Paste area 
- 5. Keepout Region area 

- 6. Ground keepout should extend through all layers to minimize coupling from RF feed to ground.
- 7. Any vias in pads should be either filled or tented to prevent solder from wicking away from the pad during reflow.
- 8. The dimension tolerances should follow standard PCB manufacturing guidelines.

## 5.2 Top Solder Paste



### NOTE:

- 1. EN/IG area 
- 2. Solder Mask area 
- 3. Copper area 
- 4. Paste area 
- 5. Keepout Region area 

- 6. Ground keepout should extend through all layers to minimize coupling from RF feed to ground.
- 7. Any vias in pads should be either filled or tented to prevent solder from wicking away from the pad during reflow.
- 8. The dimension tolerances should follow standard PCB manufacturing guidelines.

### 5.3 Top Solder Mask

This drawing is a negative of solder mask. Black regions are anti-mask.

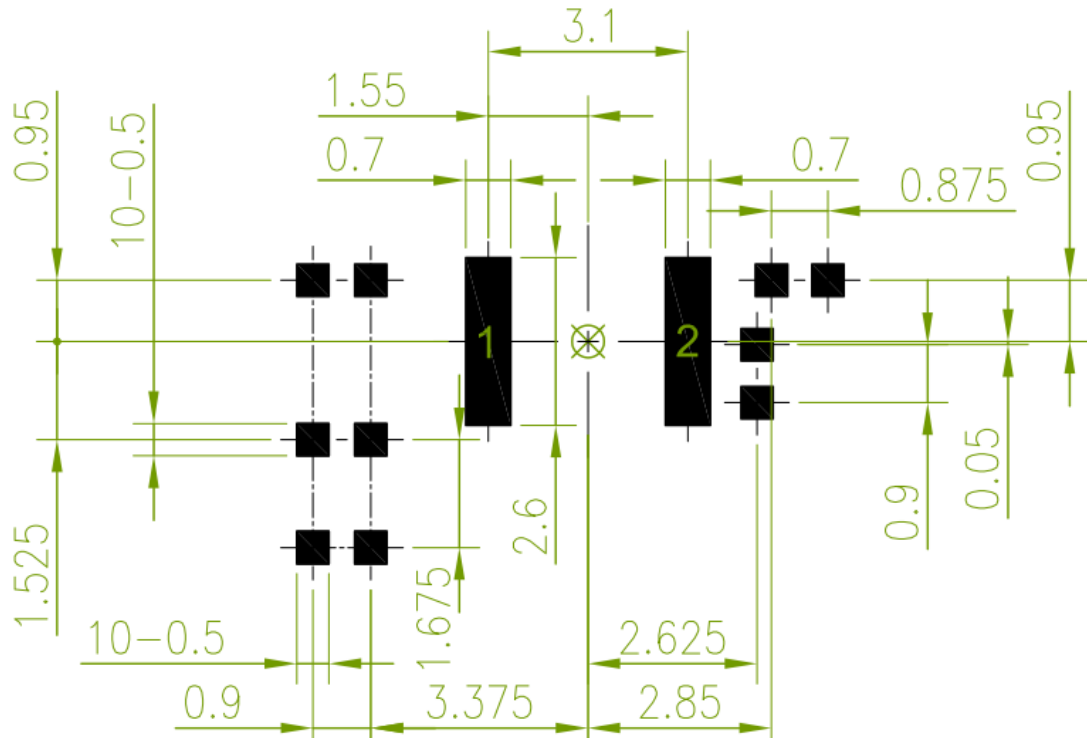

**NOTE:**

- 1. EN/IG area
- 2. Solder Mask area
- 3. Copper area
- 4. Paste area
- 5. Keepout Region area





- 6. Ground keepout should extend through all layers to minimize coupling from RF feed to ground.
- 7. Any vias in pads should be either filled or tented to prevent solder from wicking away from the pad during reflow.
- 8. The dimension tolerances should follow standard PCB manufacturing guidelines.

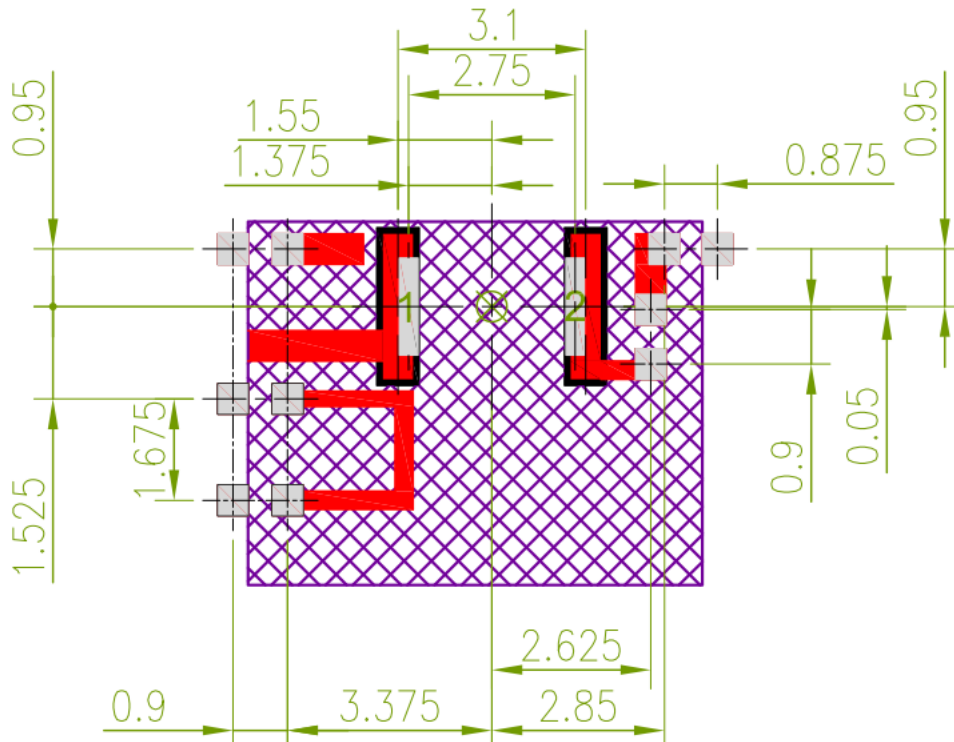

## 5.4 Composite Diagram



**NOTE:**

- 1. EN/IG area 
- 2. Solder Mask area 
- 3. Copper area 
- 4. Paste area 
- 5. Keepout Region area 

- 6. Ground keepout should extend through all layers to minimize coupling from RF feed to ground.
- 7. Any vias in pads should be either filled or tented to prevent solder from wicking away from the pad during reflow.
- 8. The dimension tolerances should follow standard PCB manufacturing guidelines.

## 5.5 Matching Circuit

Like all antennas, surrounding components, enclosures, and changes to the GND plane dimensions can alter performance. A pi-matching network like the one shown below is required in case adjustments need to be made. The antenna EVB has a similar matching network. The components on the EVB are a good starting point for a new design, but will need to be adjusted upon integration for best performance. The zero ohm resistor is needed for the ability to solder down a coax pigtail to make measurements with a vector network analyzer.

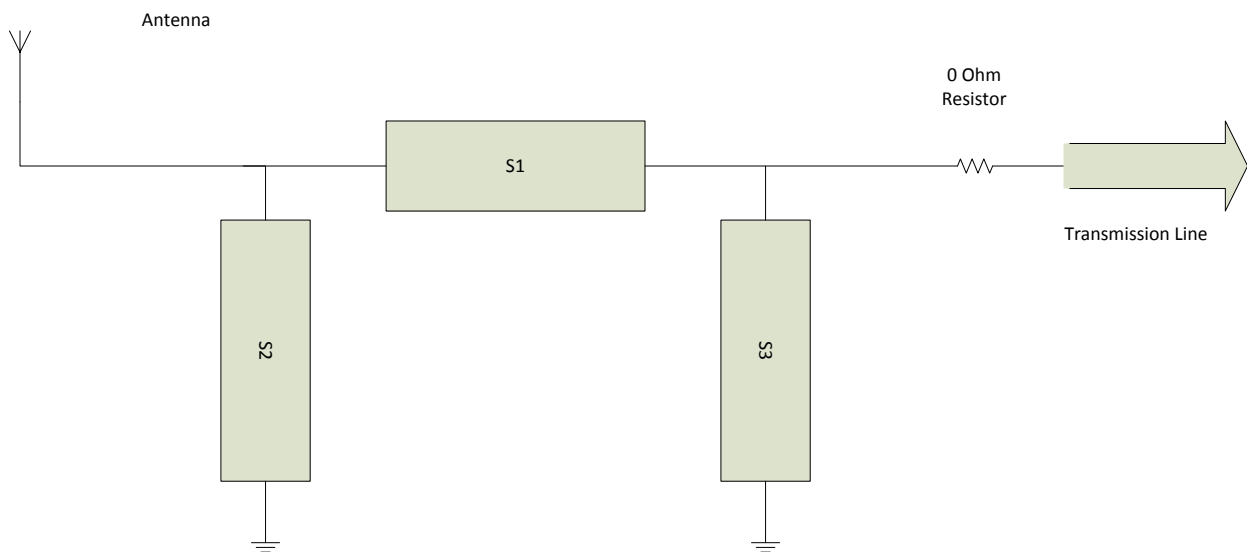

## 6. Antenna Drawings

### 6.1 Antenna Dimension

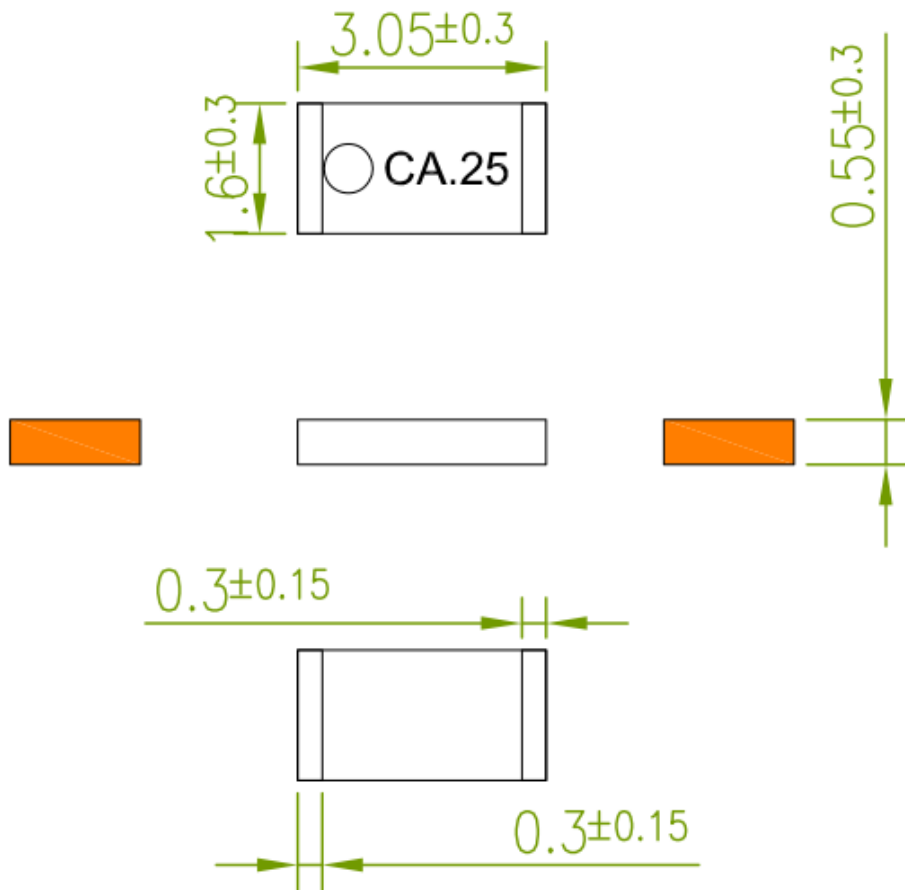

## 6.2 Antenna with Evaluation Board

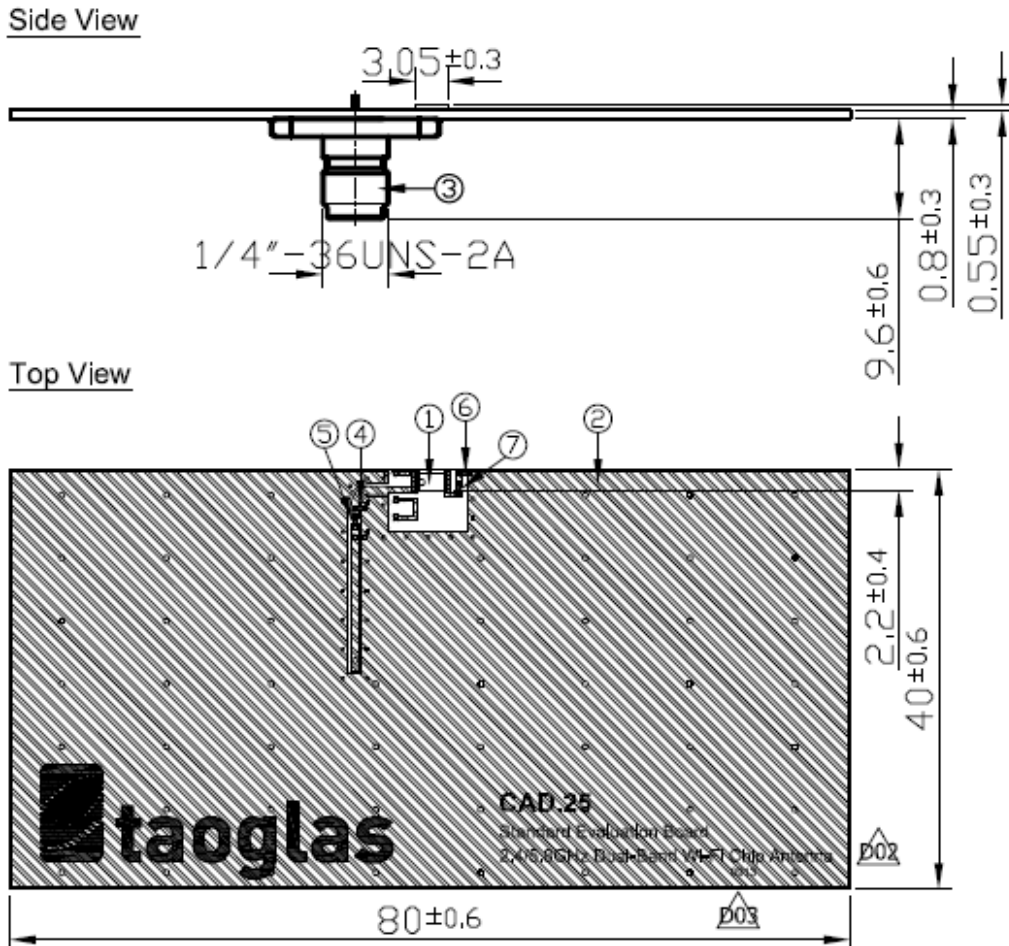

**NOTES:**

- 1. Solder Area 
- 2. Logo & Text Ink Printing : White
- 3.  Copper
- 4.  Matching Component

	Name	Material	Finish	QTY
1	CA.25 Antenna	Ceramic	N/A	1
2	CAD.25 EVB Board	FR4 0.8t	Black	1
3	SMA(F) ST	Brass	Gold	1
4	Inductor 1.2nH	Ceramic	N/A	1
5	Inductor 1nH	Ceramic	N/A	1
6	Capactor 1.2pF	Ceramic	N/A	1
7	Capactor 1pF	Ceramic	N/A	1

### 6.3 Footprint on Evaluation Board

FR4 PCB 0,8t

Front View

Back View

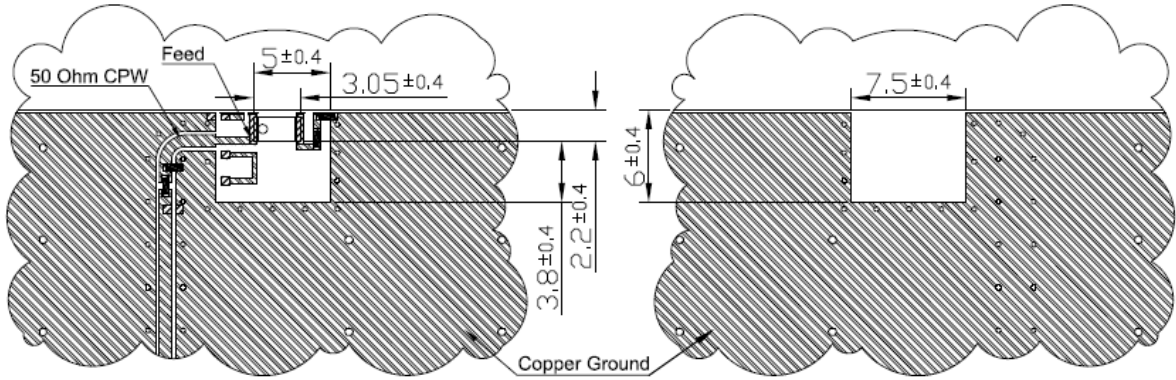

NOTES:

1. Solder Area 
2. Logo & Text Ink Printing : White
3.  Copper
4.  Matching Component

## 7. Packing

- (1) Blister tape to IEC 286-3 , polyester.
- (2) Pieces /tape : 5000 pcs (Vacuum packing).
- (3) Pieces /Carton-Inside : 10000 pcs.
- (4) Pieces /Carton-Outside : 50000 pcs.

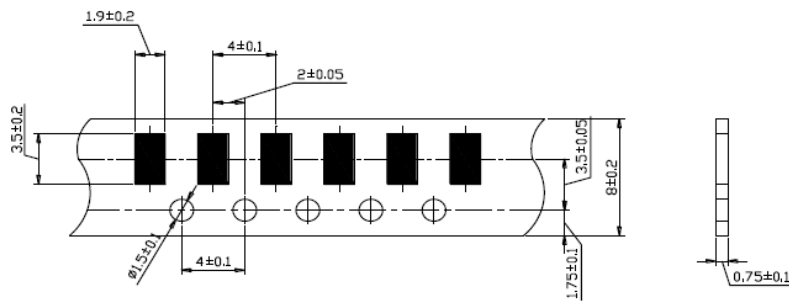
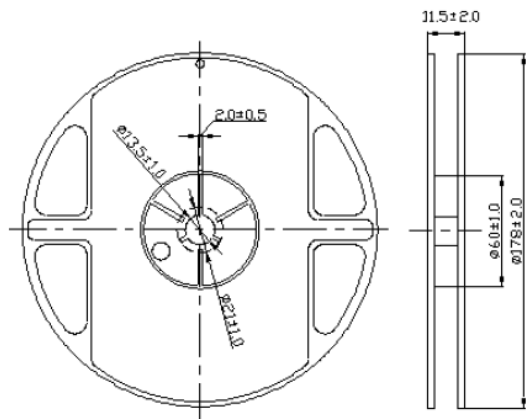

Carton-Inside

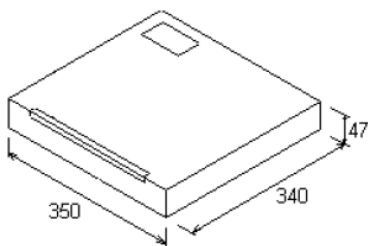

Carton-Outside

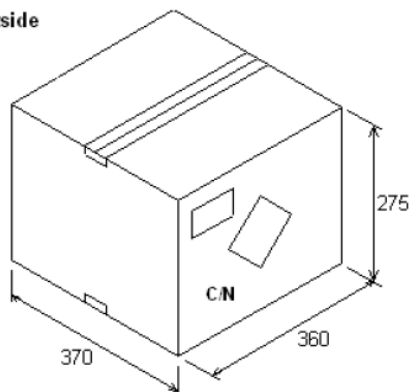

## 8. Recommended Reflow Soldering Profile

The CA.25 loop antenna can be assembled following Pb-free assembly. According to the Standard IPC/JEDEC J-STD-020C, the temperature profile suggested is shown below:

Phase	Profile features	Pb-Free Assembly(SnAgCu)
PREHEAT	Temperature Min(Tsmin)	150°C
	Temperature Max(Tsmax)	200°C
	Time(ts) from(Tsmin to Tsmax)	60-120 seconds
RAMP-UP	Avg. Ramp-up Rate(Tsmax to TP)	3°C / second(max)
REFLOW	Temperature(TL)	217°C
	Total Time above TL(t L)	30-100 seconds
PEAK	Temperature(TL) Time(tp)	260°C 5-10 second
RAMP-DOWN	Rate	6°C / second max.
	Time from 25°C to Peal Temperature	8 minutes max.
Composition of solder paste		96.5Sn/3Ag/0.5Cu
Solder Paste Model		SHENMAO PF606-P26

Note : Temperature measurement point is on top surface of the component. Damage can result if recommended temperature is exceeded.

The graphic shows temperature profile for component assembly process in reflow ovens

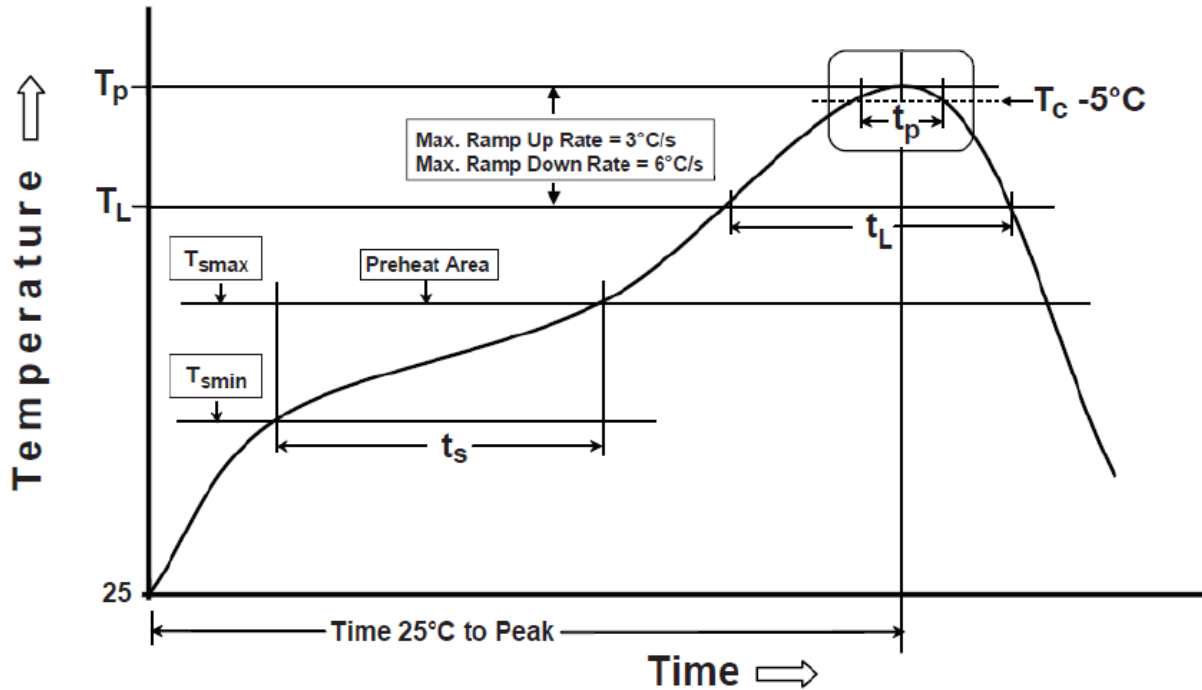

Soldering condition : Soldering iron temperature  $270 \pm 10$  °C.

Apply preheating at 120°C for 2-3 minutes. Finish soldering for each terminal within 3 seconds, if soldering iron over temperature  $270 \pm 10$  °C for 3 seconds, component surface peeling or damage may occur.

Soldering iron cannot dissipate electricity.