

R46_310, Film, Metallized Polypropylene, Safety, 0.47 uF, 10%, 310 VAC (X2), 630 VDC, 110C, Lead Spacing = 15mm

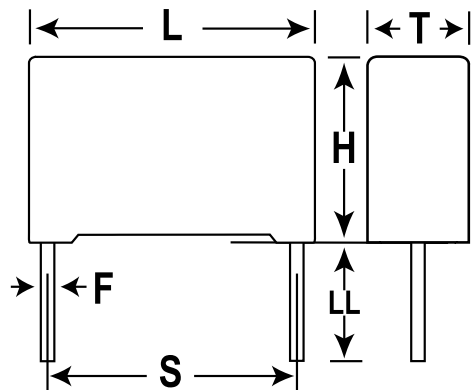

Dimensions

L	18mm +0.5mm
H	19mm +0.1mm
T	11mm +0.2mm
S	15mm +/-0.4mm
LL	4mm +2mm
F	0.8mm +/-0.05mm

Packaging Specifications

Packaging:	Bulk, Bag
Packaging Quantity:	450

General Information

Supplier:	KEMET
Series:	R46_310
Dielectric:	Metallized Polypropylene
Style:	Radial
Features:	EMI Safety
RoHS:	Yes
Lead:	Cut
Qualifications:	ENEC, UL, cUL, CQC

Specifications

Capacitance:	0.47 uF
Capacitance Tolerance:	10%
Voltage AC:	310 VAC (X2)
Voltage DC:	630 VDC
Temperature Range:	-40/+110C
Rated Temperature:	110C
Dissipation Factor:	0.10% 1kHz
Insulation Resistance:	63.8298 GOhms
Max dV/dt:	400 V/us
Safety Class:	X2