

IGBT/SiC Diode Co-pack

V_{CES}	=	1200 V
I_{CM}	=	35 A
$V_{CE(SAT)}$	=	3.0 V

Features

- Optimal Punch Through (OPT) technology
- SiC freewheeling diode
- Positive temperature coefficient for easy paralleling
- Extremely fast switching speeds
- Temperature independent switching behavior of SiC rectifier
- Best RBSOA/SCSOA capability in the industry
- High junction temperature
- Industry standard packaging

Package

- RoHS Compliant

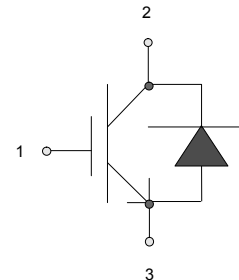
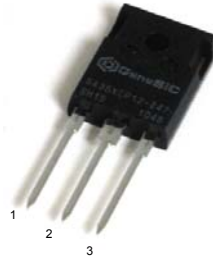
TO – 247AB
Advantages

- Industry's highest switching speeds
- High temperature operation
- Improved circuit efficiency
- Low switching losses

Applications

- Solar Inverters
- Aerospace Actuators
- Server Power Supplies
- Resonant Inverters > 100 kHz
- Inductive Heating
- Electronic Welders

Maximum Ratings, at $T_j = 150\text{ }^\circ\text{C}$, unless otherwise specified

Parameter	Symbol	Conditions	Values	Unit
IGBT				
Collector-Emitter Voltage	V_{CES}		1200	V
DC-Collector Current	I_{CM}	$T_c \leq 105\text{ }^\circ\text{C}$	35	A
Gate Emitter Peak Voltage	V_{GES}		± 20	V
Operating Temperature	T_{vj}		-40 to +150	$^\circ\text{C}$
Storage Temperature	T_{stg}		-40 to +150	$^\circ\text{C}$
Free-wheeling diode				
DC-Forward Current	I_F	$T_c \leq 105\text{ }^\circ\text{C}$	35	A
Non Repetitive Peak Forward Current	I_{FM}	$T_c = 25\text{ }^\circ\text{C}$, $t_p = 10\text{ }\mu\text{s}$	tbd	A
Surge Non Repetitive Forward Current	$I_{F,SM}$	$t_p = 10\text{ ms}$, half sine, $T_c = 25\text{ }^\circ\text{C}$	tbd	A

Thermal Characteristics

Th. Resistance Junction to Case	R_{thJC}	IGBT	0.34	K/W
Th. Resistance Junction to Case	R_{thJC}	SiC diode	0.31	K/W

Mechanical Properties

Mounting Torque	M_d	Values		
		min.	typ.	max.
		1.5		2

<http://www.genesicsemi.com/index.php/sic-products/copack>

Electrical Characteristics

Parameter	Symbol	Conditions	Values			Unit
			min.	typ.	max.	
IGBT						
Gate Threshold Voltage	$V_{GE(th)}$	$V_{GE} = V_{GE^*}, I_C = 0.6 \text{ mA}, T_J = 25^\circ\text{C}$	5.5	6	6.5	V
Collector-Emitter Leakage Current	$I_{CES,25}$	$V_{GE} = 0 \text{ V}, V_{CE} = V_{CES^*}, T_J = 25^\circ\text{C}$		0.02	0.2	mA
	$I_{CES,150}$	$V_{GE} = 0 \text{ V}, V_{CE} = V_{CES^*}, T_J = 150^\circ\text{C}$		0.3		mA
Gate-Leakage Current	I_{GES}	$V_{CE} = 0 \text{ V}, V_{GE} = 20 \text{ V}, T_J = 25^\circ\text{C}$			500	nA
Collector-Emitter Threshold Voltage	$V_{CE(TO)}$	$T_J = 25^\circ\text{C}$		1.1		V
Collector-Emitter Slope Resistance	$R_{CE,25}$	$V_{GE} = 15 \text{ V}, T_J = 25^\circ\text{C}$		50		m Ω
	$R_{CE,150}$	$V_{GE} = 15 \text{ V}, T_J = 150^\circ\text{C}$		87.5		m Ω
Collector-Emitter Saturation Voltage	$V_{CE(SAT)}$	$I_C = 35 \text{ A}, V_{GE} = 15 \text{ V}, T_J = 25^\circ\text{C}(150^\circ\text{C})$		3.0(3.9)		V
Input Capacitance	C_{ies}	$V_{GE} = 0 \text{ V}, V_{CE} = 25 \text{ V}, f = 1 \text{ MHz}$		tbid		nF
Output Capacitance	C_{oes}			tbid		nF
Reverse Transfer Capacitance	C_{res}			tbid		nF
Gate Charge	Q_g	$V_{CC} = 800 \text{ V}, I_C = 35 \text{ A}, V_{GE} = 15 \text{ V}$		50		nC
Reverse Bias Safe Operating Area	RBSOA	$T_J = 125^\circ\text{C}, R_g = 56\Omega, V_{CC} = 1200 \text{ V}, V_{GE} = 15 \text{ V}$		45		A
Short Circuit Current	I_{sc}	$T_J = 125^\circ\text{C}, R_g = 56\Omega, V_{CC} = 900 \text{ V}, V_{GE} = \pm 15 \text{ V}$		60		A
Short Circuit Duration	t_{sc}				10	μs
Rise Time	t_r	$V_{CC} = 800 \text{ V}, I_C = 35 \text{ A}, R_{gon} = R_{goff} = 22 \Omega, V_{GE(0n)} = 15 \text{ V}, V_{GE(off)} = -8 \text{ V}, T_J = 125^\circ\text{C}$		85		ns
Fall Time	t_f			205		ns
Turn On Delay Time	$t_{d(on)}$			40		ns
Turn Off Delay Time	$t_{d(off)}$			232		ns
Turn-On Energy Loss Per Pulse	E_{on}			2.66		mJ
Turn-Off Energy Loss Per Pulse	E_{off}			4.35		mJ
Free-wheeling diode						
Forward Voltage	V_F	$I_F = 35 \text{ A}, V_{GE} = 0 \text{ V}, T_J = 25^\circ\text{C} (150^\circ\text{C})$		2.6(3.5)		V
Threshold Voltage at Diode	$V_{D(TO)}$	$T_J = 25^\circ\text{C}$		0.8		V
Peak Reverse Recovery Current	I_{rrm}	$I_F = 35 \text{ A}, V_{GE} = 0 \text{ V}, V_R = 650 \text{ V}, -di_r/dt = 300 \text{ A}/\mu\text{s}, T_J = 125^\circ\text{C}$		3.01		A
Reverse Recovery Time	t_{rr}			36		ns
Diode peak rate of fall of reverse recovery current during tb	di_r/dt			190		A/ μs

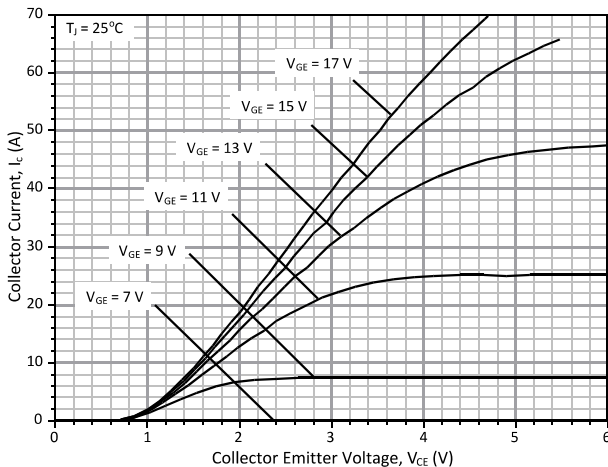

Figure 1: Typical Output Characteristics at 25 °C

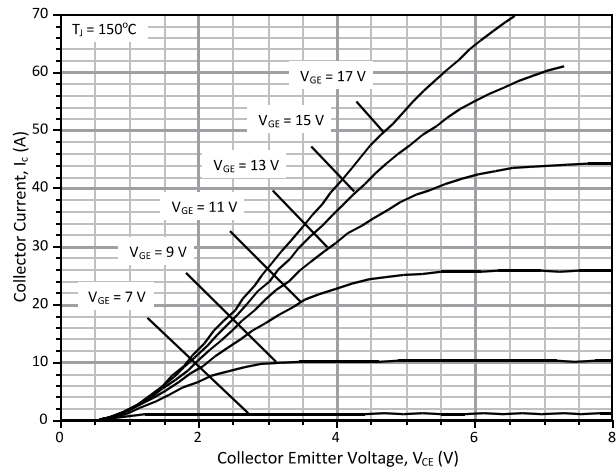

Figure 2: Typical Output Characteristics at 150 °C

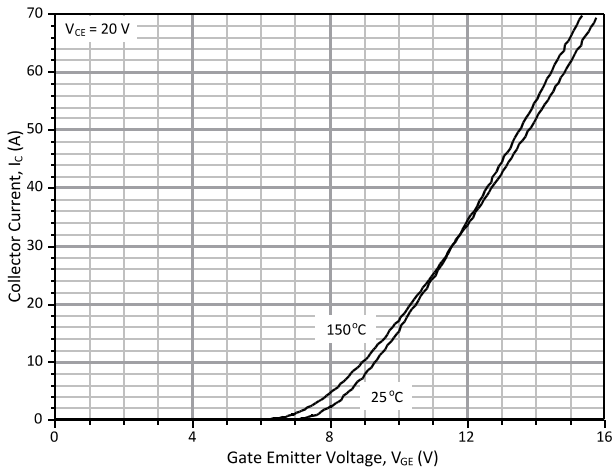

Figure 3: Typical Transfer Characteristics

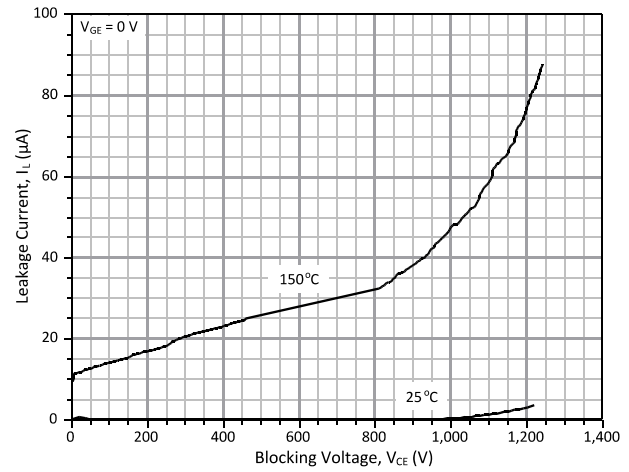

Figure 4: Typical Blocking Characteristics

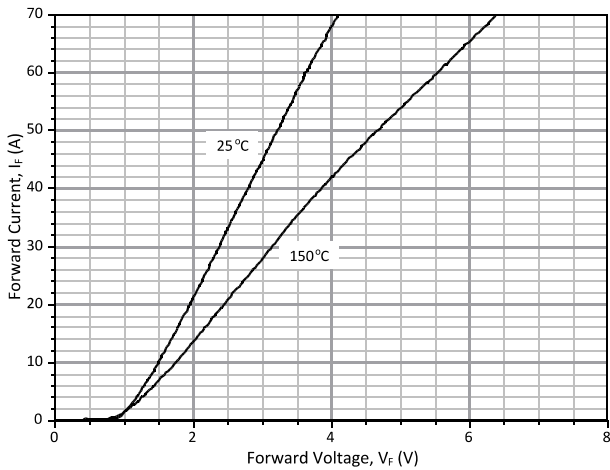

Figure 5: Typical FWD Forward Characteristics

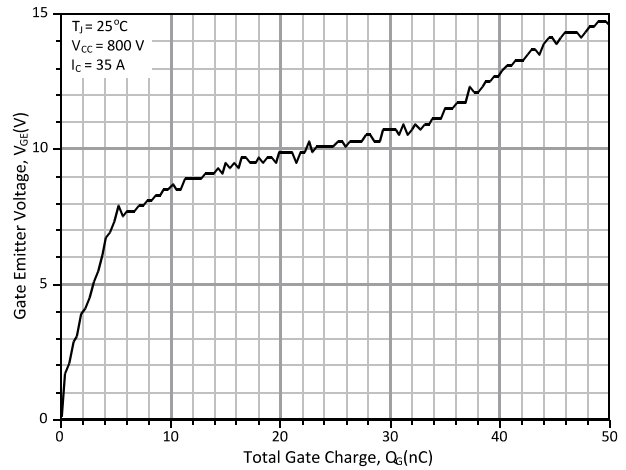

Figure 6: Typical Turn On Gate Charge

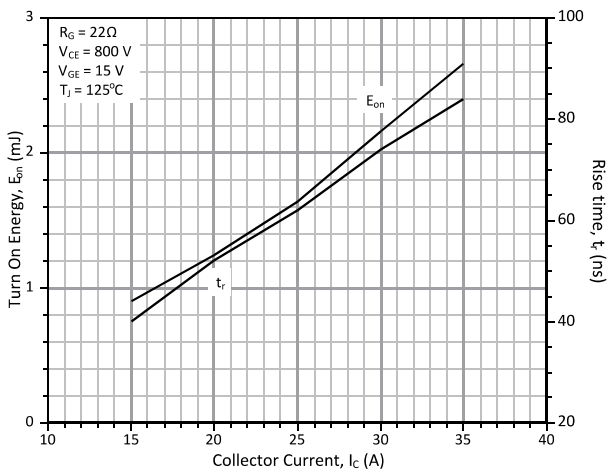

Figure 7: Typical Turn On Energy Losses and Switching Times

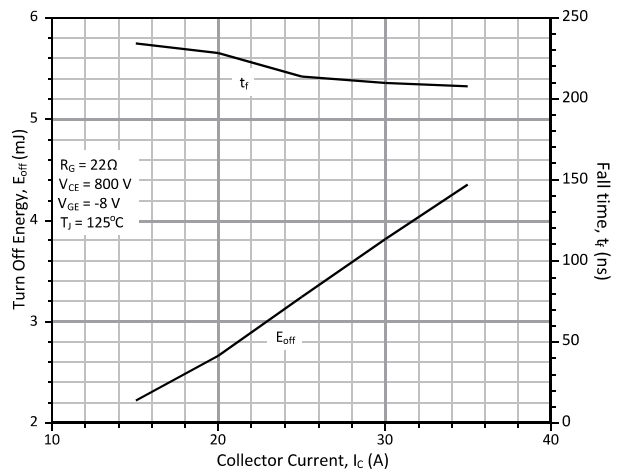

Figure 8: Typical Turn Off Energy Losses and Switching Times

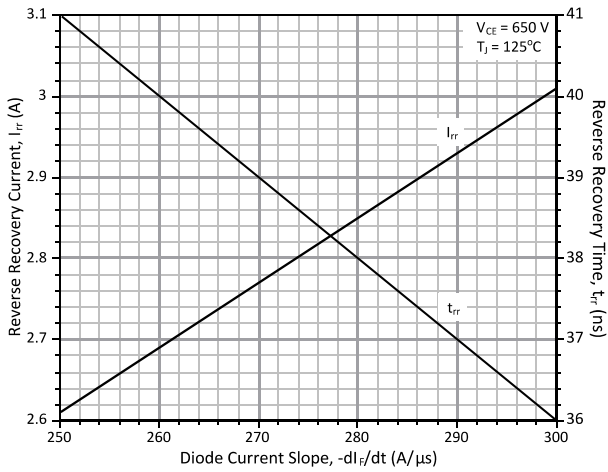
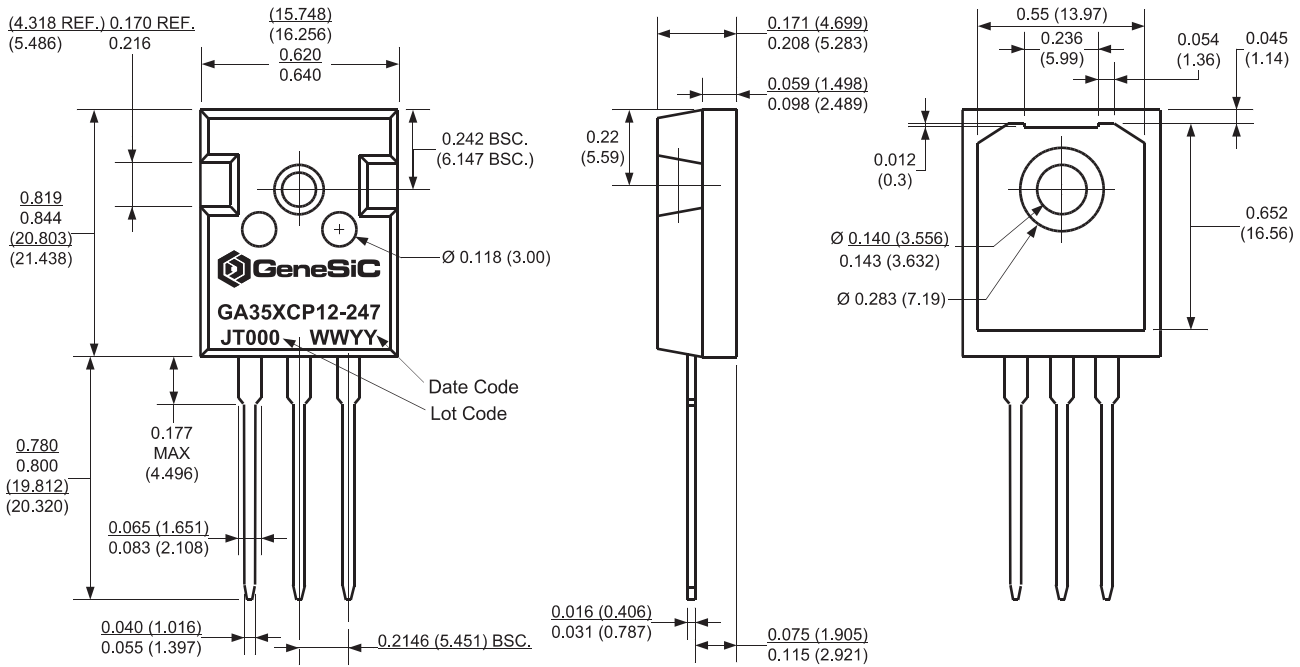

Figure 9: Typical Reverse Recovery Currents and Times

Package Dimensions:

TO-247AB

PACKAGE OUTLINE



NOTE

1. CONTROLLED DIMENSION IS INCH. DIMENSION IN BRACKET IS MILLIMETER.
2. DIMENSIONS DO NOT INCLUDE END FLASH, MOLD FLASH, MATERIAL PROTRUSIONS

Revision History

Date	Revision	Comments	Supersedes
2011/01/06	1	First generation release	

Published by
GeneSiC Semiconductor, Inc.
43670 Trade Center Place Suite 155
Dulles, VA 20166

GeneSiC Semiconductor, Inc. reserves right to make changes to the product specifications and data in this document without notice.

GeneSiC disclaims all and any warranty and liability arising out of use or application of any product. No license, express or implied to any intellectual property rights is granted by this document.

Unless otherwise expressly indicated, GeneSiC products are not designed, tested or authorized for use in life-saving, medical, aircraft navigation, communication, air traffic control and weapons systems, nor in applications where their failure may result in death, personal injury and/or property damage.